



Spraying Systems Co.
Experts in Spray Technology

CAR WASH SPRAY PRODUCTS



















THANK YOU FOR YOUR INTEREST IN OUR SPRAY PRODUCTS

Our high-quality spray products that can help you improve your car wash operations are available from most OEMs or aftermarket suppliers.



TABLE OF CONTENTS

Introduction	 A2	
Technical Reference	 A4	
Spray Nozzles	 B1	
Spray Guns	 C1	
Air Nozzles	 D1	
Accessories	 E1	
Index	 i-1	



INTRODUCTION



THE PRODUCTS YOU NEED AND PERFORMANCE YOU CAN COUNT ON

SPRAY NOZZLE PERFORMANCE DRIVES CAR WASH QUALITY, COST EFFICIENCY AND CUSTOMER SATISFACTION

As a business owner, you may not spend much time thinking about small components like spray nozzles, but the fact is that your car wash is only as good as the spray your nozzles deliver. Depending on how you select and maintain these components, they can be a source of major savings or a needless expense.

Worn nozzles or using the wrong type of nozzle can easily spray up to 30% more water and chemicals than necessary, which can amount to tens of thousands of dollars each year. The three examples on the adjacent page provide typical annual car wash operating expenses. These examples only calculate the cost of excess water and detergents caused by using nozzles spraying over capacity. Don't forget to factor in all of the additional expenses related to an inefficient spray system:

- Lost customers as a result of a poor quality wash or excessive downtime
- Excessive wastewater and disposal costs
- Additional power used by pump equipment to keep up with higher flow rates or pressure losses
- Unnecessary labor from increased maintenance

By optimizing your spray system, you can turn these unnecessary expenses into savings opportunities.



HOW MUCH CAN YOU SAVE?

CONVEYOR CAR WASH

Average cars per day:	120
Days open per year:	365
Flow per car:	40 gal
Liquid used:	1,752,000 gal
Wasted water:	262,800 gal
Wasted chemical:	2,300 gal

Annual cost of wasted water and chemical: \$24,314*

INBAY AUTOMATIC CAR WASH

Number of bays:	2
Average cars per day per bay:	40
Days open per year:	365
Flow per car:	30 gal
Liquid used:	876,000 gal
Wasted water:	131,400 gal
Wasted chemical:	1,150 gal

Annual cost of wasted water and chemical: \$12,157*

SELF-SERVE CAR WASH

Number of bays:	6
Hours of utilization: (18 hours per day x 365 days per year x 15% utilization)	985
Flow rate:	2.5 gpm
Liquid used: (150 gph x 985 hours per year x 6 bays)	886,950 gal
Wasted water:	133,042 gal
Wasted chemical:	1,164 gal

Annual cost of wasted water and chemical: \$12,305*















ASSUMPTIONS

Average cost of water:	US\$5.00/1,000 gal
Average cost of chemical:	US\$10/gal
Dilution ratio:	40:1
Chemical usage:	35%
Excess liquid sprayed:	15%

*Based on US dollar and applications

TECHNICAL REFERENCE

NOZZLE SELECTION GUIDE

Spray Pattern	Spray Angle	Application	Nozzles	Page Number
 <p>FULL CONE Uniform, round and full spray pattern with medium to large drops. Good for covering larger areas.</p>	15° to 125°	Presoak and covering larger areas.	 FullJet®	B2
 <p>HIGH PRESSURE FLAT SPRAY Provides high and uniform impact capabilities. Even spray pattern eliminates the need to overlap patterns from adjacent nozzles.</p>	5° to 80°	Pressure wash or first rinse. Any application where high impact is needed to remove dirt or detergent.	 WashJet®	B4
 <p>FLAT SPRAY Overlapping or aligning spray patterns from adjacent sprays produces uniform distribution.</p>	15° to 110°	Chemical arches or anywhere spray nozzles are aligned to overlap to produce a uniform distribution.	 VeeJet®	B13
 <p>DEFLECTED NON-TAPERED FLAT SPRAY Medium-sized drops at lower pressures with narrower spray angles. High impact. Large free passage reduces clogging.</p>	15° to 50°	Rinse arches and presoak, especially when recycled water is being used. Excellent for any application in which adjacent spray patterns do not overlap.	 FlatJet®	B20
 <p>DEFLECTED TAPERED FLAT SPRAY Medium-sized drops with tapered edges and wide spray angles at lower pressures. Can overlap patterns from adjacent sprays for even coverage. Large free passage reduces clogging.</p>	83° to 153°	Rinse arches and presoak, especially in stages that use recycled water. Good for overlapping adjacent sprays to produce uniform coverage.	 FloodJet®	B22
 <p>SOLID STREAM Uniform stream provides maximum impact.</p>	0°	Cleaning grills, rocker panels and wheel wells.	 WashJet	B10
 <p>SELF-ASPIRATING Flat spray pattern, mixes surrounding air with premixed liquid to generate foam. Medium to medium-fine foam stays on vehicle longer. Keeps energy costs down because compressed air is not required.</p>	0° to 80°	Detergent application	 FoamJet®	B26

NOZZLE SELECTION GUIDE

Wash Stage	Spray Nozzle Characteristics for Best Performance	Recommended Nozzles	Page Number
 <p>Presoak</p>	Pressure: low Flow Rate: low Impact: low Angle: wide Drop Size: large	FullJet® VeeJet® (PVDF) FloodJet® FoamJet®	B2 B18 B22 B26
 <p>Undercarriage</p>	Pressure: low Flow Rate: high Impact: medium Angle: medium Drop Size: large	VeeJet FlatJet®	B13 B20
 <p>Wash</p>	Pressure: high Flow Rate: medium Impact: high Angle: narrow Drop Size: large	WashJet®	B4
 <p>Rinse</p>	Pressure: low Flow Rate: high Impact: medium Angle: medium Drop Size: large	VeeJet FlatJet	B13 B20
 <p>Wax</p>	Pressure: low Flow Rate: low Impact: low Angle: medium Drop Size: fine	VeeJet	B13
 <p>Final Rinse</p>	Pressure: low Flow Rate: low Impact: low Angle: medium to wide Drop Size: fine	VeeJet FloodJet	B13 B22
 <p>Self-Serve</p>	Pressure: high Flow Rate: low to medium Impact: high Angle: narrow Drop Size: medium to large	WashJet	B4

TECHNICAL REFERENCE

SPRAY PRESSURE AND IMPACT

The cleaning effectiveness of a spray nozzle, impact, or the total force of the spray as it hits the vehicle, are the main criterias to evaluate spray pressure and impact. The true measure of cleaning effectiveness is impact per square inch. Maximizing the cleaning impact involves increasing both the mass of the spray and its velocity, which is accomplished by increasing flow rate in gallons (liters) per minute, droplet size or psi (bar).

Most people only think about spray pressure when it comes to impact, but increasing pressure can sometimes be counterproductive. High pressure produces smaller

droplets, which have less mass and velocity, and therefore less cleaning impact. As a general rule of thumb, increasing flow rate is much more effective than increasing pressure. Doubling the flow rate increases impact as much as 100%, while doubling pressure provides only 40% more impact.

The downside of increasing flow rate is increased water consumption, and the biggest operating cost today for a car wash is water. At a time when sustainability, water conservation and lower operating costs are high priorities, it is possible to increase pressure and maintain cleaning effectiveness with premium, high-pressure nozzles.

$$I = K \times Q \times \sqrt{P}$$

I	Total theoretical spray impact	kg
K	Constant	.0526
Q	Flow rate	lpm
P	Liquid pressure	bar

UNIT IMPACT PER SQ. INCH OF A FLAT FAN SPRAY PATTERN AT 12" FROM THE NOZZLE

Spray Angle	% of Theoretical Total Impact
15°	30%
25°	18%
35°	13%
40°	12%
50°	10%
65°	7%
80°	5%

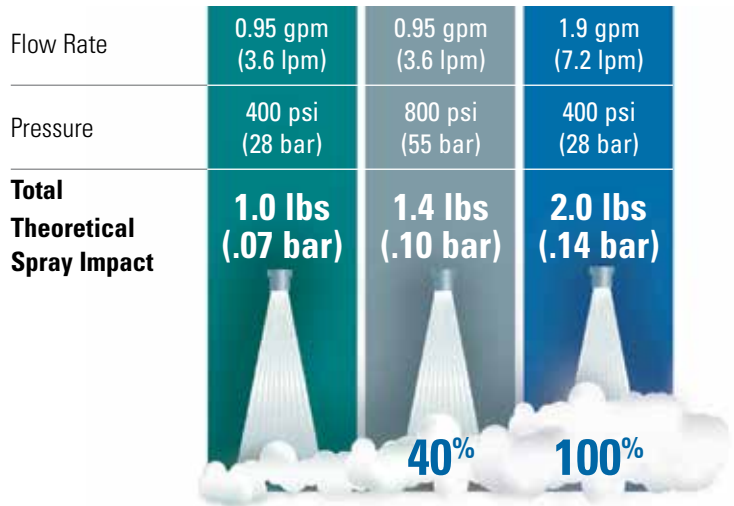

STANDARD VS. PREMIUM HIGH-PRESSURE NOZZLES

Premium, high-pressure IMEG® WashJet® nozzles are engineered to provide up to 25% greater impact than standard MEG WashJet nozzles at the same flow rate and system pressure. Though slightly more expensive than standard MEG nozzles, premium IMEG nozzles pay for themselves in enhanced cleaning efficiency and water savings. They also have a longer wear life due to the reduced system pressure and need to be replaced less frequently, leading to improved total cost of ownership.

	Standard MEG	Premium IMEG	
Impact Pressure	17 psi (1.2 bar)	17 psi (1.2 bar)	25% More Impact
System Pressure	1,500 (103.4 bar)	1,125 (77.6 bar)	
Flow Rate	2.10 gpm (3.0 ltr)	1.82 gpm (6.9 ltr)	13% Less Water & Chemicals

SPRAY DISTANCE

Spray distance dramatically affects impact, and 6 to 8 inches (15.25 to 15.35 cm) is the ideal distance to achieve the best performance from your spray nozzles. Increasing the nozzle distance just 6 inches (15.25 cm) from the car's surface will decrease impact by 50%. Why? Because droplet velocity is reduced due to the frictional drag effects of the air and because the spray pattern is much larger. The same impact force over a larger area results in less impact pressure.

When determining spray distance, use a worst-case scenario. First, estimate what is likely to be the shortest distance from a vehicle to the spray nozzle. Then, adjust nozzles so that full coverage and overlap is possible with a vehicle at the shortest distance. This will ensure full coverage and overlap with all vehicle types.

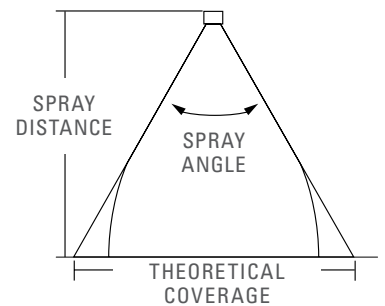

THEORETICAL SPRAY COVERAGE

Spray Angle	At various distances in centimeters from nozzle orifice					
	15	20	25	30	40	50
15°	4.0	5.3	6.6	7.9	10.5	13.2
25°	6.7	8.9	11.1	13.3	17.7	22.2
40°	10.9	14.6	18.2	21.8	29.1	36.4
65°	19.1	25.5	31.9	38.2	51.0	63.7
80°	25.2	33.6	42.0	50.4	67.1	83.9
110°	42.9	57.1	71.4	85.7	114	143

SPRAY ANGLE AND COVERAGE

Spray angle is the dispersion or width of the spray after it leaves the orifice. We are often asked if pressure affects the spray angle, and it definitely does. At high pressure, spray angles can widen significantly and produce low-impact misting of the spray as it fans out at the edges. Narrower spray angles have more cleaning force per square inch (centimeter), but they can peel some pin striping, moldings and poor paint jobs. Also, depending on the type of wash application, recommended angles vary:

- For safety reasons, it is rare to see self-serve tips at less than 25°

- In the hands of an experienced operator or in a touchless in-bay automatic, 5° to 15° nozzles do an excellent job of removing ice, bugs and grime
- Wide angle nozzles from 50° to 110° are best for the presoak stage in which full coverage of the vehicle is more important than the impact or quantity of water used

KNOW THE ANGLES, WASH STAGES AND RECOMMENDED ANGLE RANGE

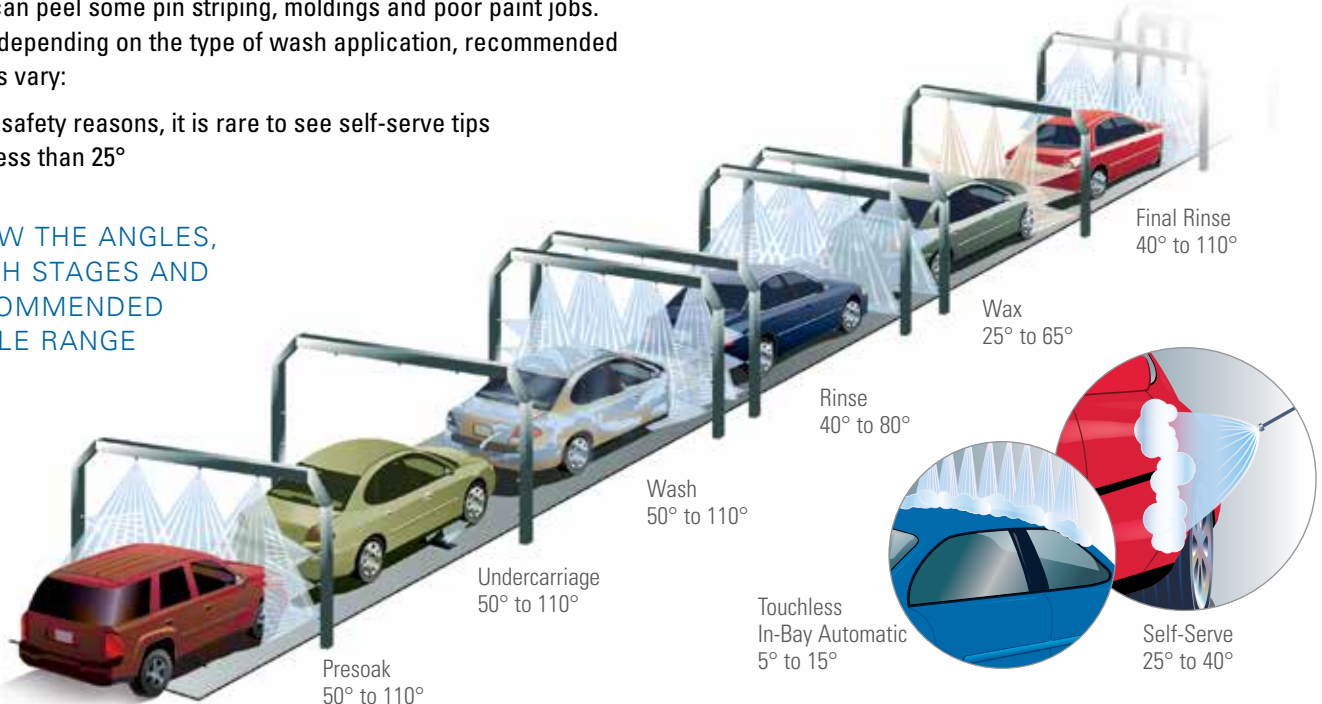

TECHNICAL REFERENCE

HOW TO MAINTAIN SPRAY NOZZLE PERFORMANCE

Selecting the right nozzle for each wash stage is just the first step toward optimizing your spray system. Follow these tactics to help extend the service life of your nozzles:

1. INCORPORATE NOZZLE INSPECTION INTO YOUR REGULAR MAINTENANCE PROGRAM

Damaged spray nozzles waste water and chemicals, decrease cleaning coverage of the vehicles and increase workload on your pumps. With thousands of dollars of profits at stake, you'll want to regularly monitor your spraying system to reveal potential problems. Some nozzle problems, like corrosion or caking, are easy to detect with a visual inspection, but a worn nozzle, the most common problem for a car wash, is almost impossible to detect with the human eye.

Watch for these clues to indicate spray nozzle problems:

- **Change in pump performance.** If you have a positive displacement pump, check the pressure gauge for a drop in system pressure. If yes, the flow rate will remain constant, but spray velocity and impact will lessen. You may not be wasting water, but the quality of your wash will suffer. Some operators will adjust the unloader valve and use it as a regulator to increase pressure, but this can create high-pressure spikes and damage the pump
- **Increased chemical consumption.** As the nozzles wear and pressure/impact decreases, some operators increase the concentration of the detergent – a much more costly solution than replacing nozzles
- **Deterioration of spray pattern.** Inspect the spray pattern for uniformity. When nozzles are damaged, worn or

clogged, the spray pattern is destroyed. Streaks develop and the spray will be heavier or lighter throughout the pattern. The result is inadequate or inconsistent coverage of the vehicle. Customers will experience uneven cleaning or drying, so you'll want to make sure your nozzles are replaced before reaching this point. Customer satisfaction and retention depends on it



- **Flow rate change.** If you have a centrifugal pump, an increased flow rate indicates nozzle wear. System pressure will remain the same, enabling you to retain some quality in your wash, but your system will be highly inefficient, wasting costly water and chemicals

2. DECREASE SPRAYING PRESSURE

Where circumstances permit, decreasing the pressure will slow the liquid velocity through the orifice and reduce the wear and corrosion rate. You can take advantage of this tactic in the presoak stage where low-pressure, small-capacity nozzles are very effective because they provide streakless, full coverage. During presoak, it's not the volume or spray impact that's critical – it's where you place the water and chemical.

3. USE CARE WHEN CLEANING SPRAY NOZZLES

Cleaning nozzles can often restore a defective spray, but

<p>1</p> <p>Spray a new nozzle into the container for a measured amount of time.</p>  <p>BOTTLE CHECK: THE SIMPLE WAY TO DETECT A FLOW RATE CHANGE Tools needed: stopwatch, measuring cup and container</p>	<p>2</p> <p>Measure out the amount of water into the measuring cup.</p> 	<p>3</p> <p>Divide the amount of water by the collection time. This will give you the gallons per minute rate of the new spray nozzle.</p> 
--	---	---

it should be done with materials that are much softer than the nozzle orifice. Use toothbrushes, toothpicks or even compressed air. Never use wire brushes, pocket knives or welder's tip cleaning rasps. It is easy to damage the critical orifice shape (or size) and end up with distorted spray patterns or excess flow. If you are faced with a stubborn clogging problem, soak the orifice in a non-corrosive cleaning chemical to soften or dissolve the substance.

4. REDUCE THE QUANTITY OF ABRASIVE PARTICLES OR THE CONCENTRATION OF CORROSIVE CHEMICALS

In some stages, you can reduce the amount of abrasive particles in the liquid to reduce wear effects. For example, use recycled water at the start of the car wash, and as the wash progresses, use less recycled water until the final rinse where only fresh water is used. Not only does this provide a better quality wash for your customers, but it also reduces the wear on nozzles at the final rinse stage. In stages where chemicals are used, the corrosive activity of a solution may be reduced by using different concentrations or temperatures, depending on the chemicals involved.

5. ADD LINE STRAINERS OR USE SPRAY NOZZLES WITH BUILT-IN STRAINERS

When using fresh or recycled water, orifice deterioration and clogging are typical problems. Strainers or spray nozzles with built-in strainers are highly recommended in the presoak cycle. Line strainers not only extend the life of the nozzle but the pump as well. The strainer's screen traps the dirt or unwanted material, and it should be made of stainless steel

for strength and corrosion resistance. The screen is critical to the operation of the strainer, and an extra screen should be kept on hand for each strainer installed.



For strainer options see page B27

WHAT CAN YOU USE TO CLEAN YOUR NOZZLES?

Yes	No
Toothbrush	Wire Brush
Toothpick	Pocket Knife
Compressed Air	Welder's Tip Cleaning Rasp

4

Take a baseline measurement using a new nozzle in each section of your car wash.

5

Repeat the test periodically on the same nozzles and record the date or number of wash cycles since the previous test. As the nozzles begin to wear, the flow rate will increase. Creating a log will help you determine how quickly your nozzles are wearing.

TECHNICAL REFERENCE

COMMON CAUSES OF SPRAY NOZZLE PROBLEMS

EROSION/WEAR LIFE

Erosion is the single biggest source of nozzle problems in car wash operations. Gradual abrasion of material from the spray nozzle orifice and internal flow passages cause them to enlarge and/or become distorted. As a result, flow usually increases, pressure may decrease, the spray pattern becomes irregular and liquid drops become larger. Spray pressure, fluid abrasiveness, nozzle orifice size and chemical compatibility are just a few of the factors that play a role in a nozzle's wear life.

APPROXIMATE ABRASION RESISTANCE RATIOS

Nozzle Material	Resistance Ratio
Brass	1
PVDF	3
Stainless Steel	4 – 6
Hardened Stainless Steel	10 – 15
Ceramics	90 – 200

CAKING

Build-up of material on the inside and outer edges or near the orifice is caused by liquid evaporation. A layer of dried solids remains and obstructs the orifice or internal flow passages.



CLOGGING

Unwanted solid particles can block the inside of the orifice. Flow is restricted, and spray pattern uniformity is disturbed. This is often a problem when re-circulated water is insufficiently filtrated.

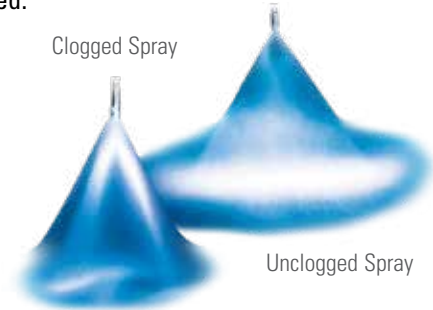

ACCIDENTAL DAMAGE

Damage can occur if a spray nozzle is dropped or scratched during installation, operation or cleaning. This is a common occurrence in self-service car washes, since many customers often let spray wands fall onto, or scrape against, the concrete floor of the bay.



CORROSION

Spray nozzle material also can break down due to the chemical qualities of the sprayed material or the environment. The effect is similar to that caused by erosion and wear, with possible additional damage to the outside surfaces of the spray nozzle.



IMPROPER ASSEMBLY

Some spray nozzles require careful re-assembly after cleaning so that internal components such as gaskets, O-rings and vanes are properly aligned. Improper positioning or even over-tightening of nozzle caps can strip threads and can cause leaking and inefficient spray performance.

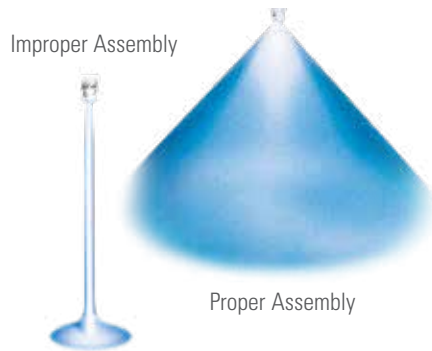

REPLACING WORN NOZZLES

Inspecting and maintaining your nozzles on a regular basis will help identify wear and extend service life. However, wear will occur over time and the only solution is to replace your nozzles. Here are a few guidelines to help you determine the optimal replacement interval:

- Are worn nozzles affecting product or process quality? If so, replace nozzles as soon as any wear is evident
- Is water conservation a priority? If so, replace nozzles as soon as wear is evident
- How much are you spending by continuing to use worn nozzles? How do the additional costs for water, soap, electricity and wastewater disposal compare with the cost of replacement nozzles?

For more information on nozzle maintenance and replacement, visit spray.com. Or, contact your local sales engineer for assistance developing a nozzle maintenance program.

WEAR LIFE: PUTTING NOZZLES TO THE TEST

Most high-pressure nozzles are currently constructed of hardened stainless steel, however, not all manufacturers use the same hardening process, which can lessen the durability of the material. To prove this point, we tested our WashJet® nozzles, made of hardened stainless steel, against a competitor’s similar nozzle. The competitor’s nozzle reached a 10 percent wear point more than twice as fast as the WashJet nozzle.

Nozzles with ceramic orifices are able to withstand harsh cleaning chemicals and high temperatures. Nozzles constructed of PVDF, a very tough plastic material, are good choices for high-temperature wax sealing applications.

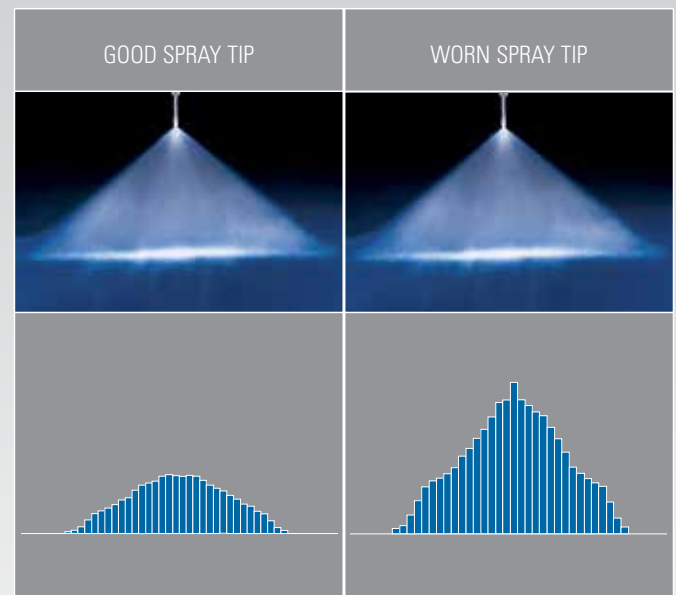

Spray patterns of both tips show little difference. Spray collection in tubes gives dramatic evidence of 30% increase in capacity.

FREQUENTLY ASKED QUESTIONS

FREQUENTLY ASKED QUESTIONS

CAN I USE A STANDARD “FAN” NOZZLE FOR THE HIGH-PRESSURE WASH PORTION OF MY CAR WASH?

A standard VeeJet® or UniJet® “fan” type nozzle is not the best choice for high-pressure applications. The orifice is designed to provide a great spray pattern at lower pressures. The WashJet® product line, however, was designed specifically to operate in high-pressure applications and will provide improved cleaning effectiveness and a better distribution of impact across the entire spray pattern.

HOW OFTEN SHOULD I REPLACE MY SPRAY NOZZLES?

Depending on your system, we would suggest cleaning your spray nozzles every couple of months and replacing them every 6 to 12 months. Preferably, you want to replace them right before the season in which your business picks up. It is difficult to determine when your wash needs new nozzles because it depends on so many factors. How good is your filtration or recycling system? How corrosive are your chemicals? At what temperature and pressure are you spraying? All these factors affect how your nozzles wear. When you replace your nozzles, take note of the difference in spray appearance, pressure reading for your system and the flow rate. You might be surprised at how much waste in water and chemical your car wash was operating with before the replacement.

MY WATER BILL IS GOING UP AND MY BOTTLE CHECK TESTS SHOW THAT MY FLOW RATE IS UP, BUT MY NOZZLES ARE FINE AND THE SPRAY PATTERN LOOKS NICE AND CLEAN. WHAT IS GOING ON?

Simply put, your nozzles are wearing normally. A nozzle can be spraying up to 30% over capacity with no streaks or other visual problems. Close monitoring and maintenance are critical to understanding what happens to the nozzles in your system over time.

AFTER A CAR PASSES THE FOAM STICKS ON MY CONVEYOR, THE FOAM DRIPS OUT THE BOTTOM HOLE AND ALL THAT CHEMICAL IS WASTED. HOW CAN I SOLVE THIS PROBLEM?

Normally, we would recommend that every nozzle in your entire system has a check valve installed immediately behind it. That way, after the car passes and the pressure in the arch drops, the check valve shuts off preventing all the water and chemical from draining out. An additional benefit is that when the next car comes down the line, your arch is already filled and the nozzles spray immediately. Unfortunately, it is extremely difficult to use either an in-line or diaphragm type check valve on pre-generated foam. It just does not work well. One alternative is to replace your foam sticks with FoamJet® nozzles. These nozzles are self-aspirating and generate the foam after the liquid passes the check valve. This gives you the added benefit of eliminating your compressed air requirement and allows you to control the foam’s capacity and spray angle.

I HAVE SEEN A LOT OF PLASTIC NOZZLE TIPS AVAILABLE, BUT I AM CONCERNED ABOUT WHERE TO USE THEM. WHAT ARE THE BEST APPLICATIONS FOR PLASTIC NOZZLES IN MY CAR WASH?

Plastic nozzles are perfect solutions to low pressure applications with corrosive chemicals. Constructed of molded PVDF, the plastic VeeJet spray nozzles are more economical than metal nozzles, withstand a variety of temperature ranges, and are resistant to acids, bases and oxidizing agents. Additionally, they are rated up to 500 psi (34.5 bar) and have a surprisingly high wear resistance. You can confidently use plastic nozzles in the presoak, rinse and wax sections of your wash.



SPRAY TIP:

If your fluid system has a lot of twists and turns, request nozzles with stabilizer vane inserts to reduce turbulence and deliver more cleaning impact.



SPRAY NOZZLES

	PAGE		PAGE
FullJet® Nozzles	 B2	FlatJet® Nozzles	 B20
WashJet® Nozzles	 B4	FloodJet® Nozzles	 B22
CERAMAX WashJet CERMEG Nozzles	 B8	UniJet® Nozzles and Components	 B24
Quick-Connect WashJet Nozzles	 B10	Foaming	 B26
VeeJet® Nozzles	 B13	Retainers	 B29
Kynar H1/4U VeeJet Nozzles	 B16	Valves/Stabilizers	 B30
Kynar H1/4VV VeeJet Nozzles	 B18	Strainers	 B31



OVERVIEW: FULLJET NOZZLES

- Solid, cone-shaped spray pattern with round impact area
- Unique vane design with large flow passages provides superior control and uniform distribution
- Standard angles: 50° to 80° at 10 psi (0.7 bar)
- Wide angles: 120° to 125° at 10 psi (0.7 bar)

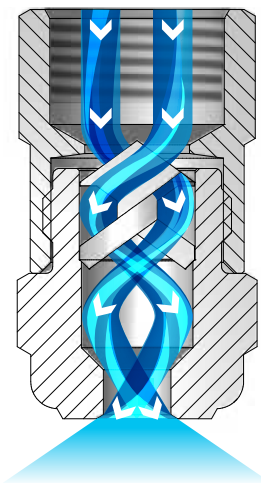

FullJet GG and HH Nozzles

The liquid enters the nozzle and proceeds through the vane. The vane causes the liquid to swirl. The design of the nozzle ensures the liquid continues to swirl as it enters the orifice. The liquid breaks up as it exits the nozzle orifice, forming a well-defined cone pattern. The drops are uniform in size and distributed equally throughout the spray pattern.

FULLJET NOZZLE OPTIONS



GG
1/8" to 1/4" male conn.
Removable cap and vane



GG-W
1/8" to 1/4" male conn. Removable
cap and vane



HH
1/8" to 1/4" male conn.
One-piece body

IDEAL FOR:

- Presoak
- Areas requiring good coverage



HH-W
1/8" to 1/4" male conn.
One-piece body

MATERIAL OPTIONS

Material	Code
Brass	(none)
Mild Steel	I
303 Stainless Steel	SS
316 Stainless Steel	316SS
Polyvinyl Chloride	PVC

Other materials available upon request.

ORDERING INFORMATION

FULLJET GG, GG-W, HH AND HH-W

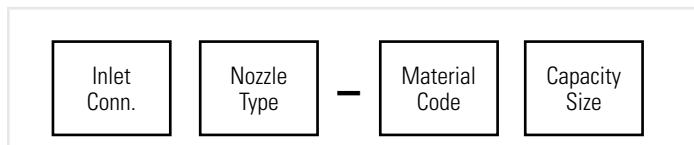

BSPT connections require the addition of a "B" prior to the inlet connection.

PERFORMANCE DATA:
STANDARD ANGLE SPRAY



Inlet Conn. (in.)	Nozzle Type		Capacity Size	Orifice Dia. Nom. (mm)	Max. Free Passage Dia. (mm)	Flow Rate Capacity (liters per minute)							Spray Angle (°)			
	GG	HH				0.4 bar	0.5 bar	0.7 bar	1.5 bar	3 bar	6 bar	7 bar	10 bar	0.5 bar	1.5 bar	6 bar
1/8	●	●	1	.79	.64	–	–	.38	.54	.74	1.0	1.1	1.3	–	58	53
	●	●	1.5	1.2	.64	.44	.49	.57	.80	1.1	1.5	1.6	1.9	52	65	59
	●	●	2	1.2	1.0	.59	.65	.76	1.1	1.5	2.0	2.2	2.6	43	50	46
	●	●	3	1.5	1.0	.88	.98	1.1	1.6	2.2	3.1	3.3	3.9	52	65	59
	●	●	3.5	1.6	1.3	1.0	1.1	1.3	1.9	2.6	3.6	3.8	4.5	43	50	46
			3.9	2.0	1.0	1.1	1.3	1.5	2.1	2.9	4.0	4.3	5.1	77	84	79
	●	●	5	2.0	1.3	1.5	1.6	1.9	2.7	3.7	5.1	5.5	6.5	52	65	59
1/4			6.1	2.3	1.3	1.8	2.0	2.3	3.3	4.5	6.2	6.7	7.9	69	74	68
	●	●	6.5	2.4	1.6	1.9	2.1	2.5	3.5	4.8	6.7	7.1	8.4	45	50	46
	●	●	10	3.2	1.6	3.0	3.3	3.8	5.4	7.5	10.3	11.0	13.0	58	67	61
	●		12.5	3.2	1.6	3.7	4.1	4.8	6.8	9.3	12.8	13.7	16.2	69	74	68

Maximum Free Passage Diameter is the maximum diameter as listed of foreign matter that can pass through the nozzle without clogging.

Highlighted column shows the rated pressure.

PERFORMANCE DATA:
WIDE ANGLE NOZZLES



Inlet Conn. (in.)	Nozzle Type		Capacity Size	Orifice Dia. Nom. (mm)	Max. Free Passage Dia. (mm)	Flow Rate Capacity (liters per minute)						Spray Angle (°)			
	GG-W	HH-W				0.4 bar	0.5 bar	0.7 bar	1 bar	1.5 bar	3 bar	6 bar	0.4 bar	0.7 bar	6 bar
1/8	●		1.5W	1.2	.64	–	–	.57	.67	.80	1.1	1.5	–	120	86
	●	●	2.8W	1.6	1.0	–	–	1.1	1.2	1.5	2.0	2.7	–	120	102
	●	●	4.3W	2.0	1.0	–	–	1.6	1.9	2.3	3.1	4.2	–	120	102
	●		5.6W	2.4	1.0	–	1.8	2.1	2.5	3.0	4.0	5.5	–	120	102
	●	●	8W	2.4	1.3	–	2.6	3.0	3.6	4.3	6.0	8.2	–	120	103
1/4	●		10W	2.8	1.3	3.0	3.3	3.8	4.5	5.4	7.5	10.3	112	120	103
	●		12W	3.2	1.3	3.5	3.9	4.6	5.4	6.5	8.9	12.3	114	120	103
	●	●	14W	3.6	1.6	4.2	4.6	5.3	6.2	7.5	10.2	13.8	114	120	103

Maximum Free Passage Diameter is the maximum diameter as listed of foreign matter that can pass through the nozzle without clogging.

Highlighted column shows the rated pressure.

DIMENSIONS AND WEIGHTS

Nozzle	Nozzle Type	Inlet Conn. (in.)	L (mm)	D (Dia.) (mm)	Hex (in.)	Net Weight (kg)
	GG, GG-W (M)	1/8	32.5	–	9/16	0.02
		1/4	39.5	–	11/16	0.04

Based on largest/heaviest version of each type.

Nozzle	Nozzle Type	Inlet Conn. (in.)	L (mm)	D (Dia.) (mm)	Hex (in.)	Net Weight (kg)
	HH, HH-W (M)	1/8	22.2	12.7	–	0.01
		1/4	22.4	13.5	–	0.01

Based on largest/heaviest version of each type.

**HIGH PRESSURE
FLAT SPRAY**

WASHJET® NOZZLES

OVERVIEW: WASHJET NOZZLES

- High pressure, high impact solid stream (0°) or flat fan spray pattern
- Spray angles of 5° to 80° at operating pressures from 300 to 5000 psi (20 to 345 bar)
- Uniform distribution by using internal guide vane to stabilize liquid turbulence
- Longer wear life and flow control accuracy with specially hardened stainless steel construction
- Patented design optimizes fluid dynamics to minimize turbulence and maximize spray performance

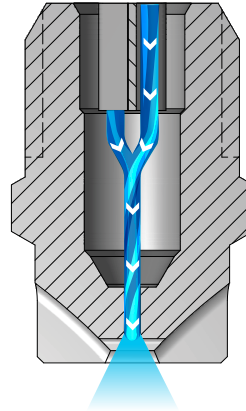

WashJet Nozzles

As the liquid exits through the rounded U shape of the orifice, it forms into a flat spray pattern. The distribution is even at pressures above 300 psi (20 bar).

WASHJET NOZZLE OPTIONS



MEG
1/8" to 1/4" male conn.



WEG
1/8" to 1/4" female conn.



IMEG®
1/8" to 1/4" male conn.

IDEAL FOR:

- Grill, rocker panel and wheel well cleaning

ORDERING INFORMATION

WASHJET MEG, WEG AND IMEG WITH GUIDE VANE

Inlet Conn.	Nozzle Type	-	Spray Angle	Capacity Size	Example
					1/4 MEG - 15 04

BSPT connections require the addition of a "B" prior to the inlet connection.

WASHJET MEG, WEG AND IMEG WITHOUT GUIDE VANE

Inlet Conn.	Nozzle Type	-	Spray Angle	Capacity Size	Example
					1/4 SAMEG - 15 04

BSPT connections require the addition of a "B" prior to the inlet connection.

MEG, WEG AND IMEG® IMPACT DATA

Spray angle: 15°
Capacity size: 04
Pressure: 2000 psig (138 bar)
Spray height: 6" (15.2 cm)

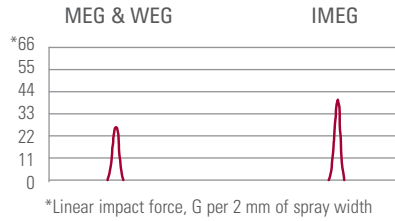
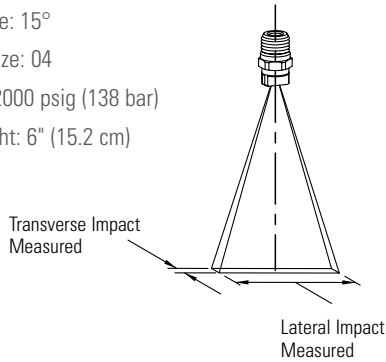

*Linear impact force, G per 2 mm of spray width

TRANSVERSE IMPACT

IMEG provides 25 to 100% more impact (dependent on nozzle size and angle)

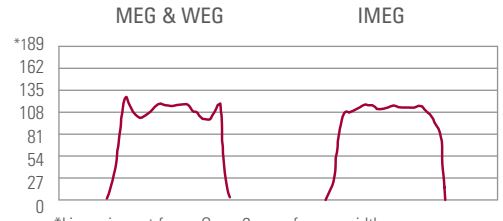

*Linear impact force, G per 2 mm of spray width

LATERAL IMPACT

IMEG provides more evenly distributed impact

PERFORMANCE DATA:
STANDARD ANGLE SPRAY

Nozzle Type and Spray Angle														Capacity Size	Flow Rate Capacity (liters per minute)							
1/8 MEG							1/4 MEG								20 bar	35 bar	50 bar	80 bar	100 bar	140 bar	170 bar	200 bar
0°*	5°	15°	25°	40°	50°	65°	0°*	5°	15°	25°	40°	50°	65°									
										●				01	1.0	1.3	1.6	2.0	2.3	2.7	3.0	3.2
										●				015	1.5	2.0	2.4	3.1	3.4	4.0	4.5	4.8
●	●	●	●	●			●	●	●	●	●	●	●	02	2.0	2.7	3.2	4.1	4.6	5.4	5.9	6.4
													●	025	2.5	3.4	4.0	5.1	5.7	6.7	7.4	8.1
●		●	●	●	●		●	●	●	●	●	●	●	03	3.1	4.0	4.8	6.1	6.8	8.1	8.9	9.7
							●		●	●	●			035	3.6	4.7	5.6	7.1	8.0	9.4	10.4	11.3
●		●	●	●	●		●	●	●	●	●	●	●	04	4.1	5.4	6.4	8.2	9.1	10.8	11.9	12.9
●		●	●	●			●		●	●	●		●	045	4.6	6.1	7.3	9.2	10.3	12.1	13.4	14.5
●	●	●	●	●	●		●	●	●	●	●	●	●	05	5.1	6.7	8.1	10.2	11.4	13.5	14.9	16.1
●		●	●	●	●		●	●	●	●	●	●	●	055	5.6	7.4	8.9	11.2	12.5	14.8	16.3	17.7
●	●	●	●	●	●		●	●	●	●	●	●	●	06	6.1	8.1	9.7	12.2	13.7	16.2	17.8	19.3
●		●	●	●			●		●	●	●		●	065	6.6	8.8	10.5	13.3	14.8	17.5	19.3	21
●	●	●	●	●	●		●	●	●	●	●	●	●	07	7.1	9.4	11.3	14.3	16.0	18.9	21	23
●		●	●	●			●		●	●	●			075	7.6	10.1	12.1	15.3	17.1	20	22	24
●		●	●	●	●		●	●	●	●	●	●	●	08	8.2	10.8	12.9	16.3	18.2	22	24	26
●		●	●	●			●		●	●	●			085	8.7	11.5	13.7	17.3	19.4	23	25	27
●		●	●	●	●		●	●	●	●	●	●	●	09	9.2	12.1	14.5	18.3	21	24	27	29
		●	●				●		●					095	9.7	12.8	15.3	19.4	22	26	28	31
●		●	●	●	●		●		●	●	●	●	●	10	10.2	13.5	16.1	20	23	27	30	32
●			●				●		●	●	●			11	11.2	14.8	17.7	22	25	30	33	35
●		●	●											115	11.7	15.5	18.5	23	26	31	34	37
●				●			●	●	●	●	●	●	●	12	12.2	16.2	19.3	24	27	32	36	39
●							●		●	●	●			125	12.7	16.9	20	25	28	34	37	40

*0° = Solid Stream.

**HIGH PRESSURE
FLAT SPRAY**

WASHJET® NOZZLES

**PERFORMANCE DATA:
STANDARD ANGLE SPRAY**

Nozzle Type and Spray Angle														Capacity Size	Flow Rate Capacity (liters per minute)								
1/8 WEG							1/4 WEG								20 bar	35 bar	50 bar	80 bar	100 bar	140 bar	170 bar	200 bar	
0°*	5°	15°	25°	40°	50°	65°	0°*	5°	15°	25°	40°	50°	65°										
		•	•	•										03	3.1	4.0	4.8	6.1	6.8	8.1	8.9	9.7	
•		•	•	•	•	•	•			•	•	•		•	04	4.1	5.4	6.4	8.2	9.1	10.8	11.9	12.9
		•	•	•						•	•	•			045	4.6	6.1	7.3	9.2	10.3	12.1	13.4	14.5
•		•	•	•	•	•	•			•	•	•	•	•	05	5.1	6.7	8.1	10.2	11.4	13.5	14.9	16.1
•		•	•	•	•	•	•			•	•				055	5.6	7.4	8.9	11.2	12.5	14.8	16.3	17.7
•		•	•	•	•	•	•			•	•	•			06	6.1	8.1	9.7	12.2	13.7	16.2	17.8	19.3
				•						•					065	6.6	8.8	10.5	13.3	14.8	17.5	19.3	21
•		•	•	•	•	•	•			•	•	•		•	07	7.1	9.4	11.3	14.3	16.0	18.9	21	23
•		•	•	•	•	•	•			•	•	•			08	8.2	10.8	12.9	16.3	18.2	22	24	26
•		•	•	•											085	8.7	11.5	13.7	17.3	19.4	23	25	27
•		•	•	•	•	•	•			•	•	•			09	9.2	12.1	14.5	18.3	21	24	27	29
			•												095	9.7	12.8	15.3	19.4	22	26	28	31
•		•	•	•	•	•	•			•	•	•			10	10.2	13.5	16.1	20	23	27	30	32
							•								15	15.3	20	24	31	34	40	45	48
		•													16	16.3	22	26	33	36	43	48	52
•															20	20	27	32	41	46	54	59	64
							•								30	31	40	48	61	68	81	89	97

*0° = Solid Stream.



**PERFORMANCE DATA:
STANDARD ANGLE SPRAY**

Inlet Conn. (in.)	Nozzle Type	Spray Angle at 3 bar								Capacity Size	Flow Rate Capacity (liters per minute)									
		IMEG®	5°	10°	15°	25°	40°	50°	65°		80°	20 bar	35 bar	50 bar	80 bar	100 bar	140 bar	170 bar	200 bar	250 bar
1/8, 1/4	•			•	•					02	2.0	2.7	3.2	4.1	4.6	5.4	5.9	6.4	7.1	7.4
	•	•	•	•	•	•	•	•	•	03	3.1	4.0	4.8	6.1	6.8	8.1	8.9	9.7	10.8	11.3
	•	•	•	•	•	•	•	•	•	035	3.6	4.7	5.6	7.1	8.0	9.4	10.4	11.3	12.6	13.2
	•	•	•	•	•	•	•	•	•	04	4.1	5.4	6.4	8.2	9.1	10.8	11.9	12.9	14.4	15.1
	•	•	•	•	•	•	•	•	•	045	4.6	6.1	7.3	9.2	10.3	12.1	13.4	14.5	16.2	17.0
	•	•	•	•	•	•	•	•	•	05	5.1	6.7	8.1	10.2	11.4	13.5	14.9	16.1	18.0	18.9
	•	•	•	•	•	•	•	•	•	055	5.6	7.4	8.9	11.2	12.5	14.8	16.3	17.7	19.8	21
	•	•	•	•	•	•	•	•	•	06	6.1	8.1	9.7	12.2	13.7	16.2	17.8	19.3	22	23
	•	•	•	•	•	•	•	•	•	065	6.6	8.8	10.5	13.3	14.8	17.5	19.3	21	23	25
	•	•	•	•	•	•	•	•	•	07	7.1	9.4	11.3	14.3	16.0	18.9	21	23	25	26
	•	•	•	•	•	•	•	•	•	075	7.6	10.1	12.1	15.3	17.1	20	22	24	27	28
	•	•	•	•	•	•	•	•	•	08	8.2	10.8	12.9	16.3	18.2	22	24	26	29	30

DIMENSIONS AND WEIGHTS

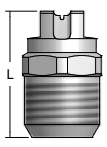
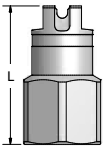
Nozzle	Nozzle Type	Inlet Conn. (in.)	L (mm)	Hex. (in.)	Flats (mm)	Net Weight (kg)
	MEG (M)	1/8	25.4	9/16	7.9	0.02
		1/4	25.4	9/16	10.3	0.02
	WEG (F)	1/8	28.6	1/2	7.9	0.03
		1/4	28.6	5/8	7.9	0.02

Based on largest/heaviest version of each type.

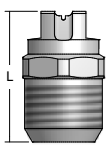
Nozzle	Nozzle Type	Inlet Conn. (in.)	L (mm)	Hex. (in.)	Flats (mm)	Net Weight (kg)
	IMEG (M)	1/8	22.2	1/2	7.9	0.02
		1/4	23.0	9/16	10.3	0.02

Based on largest/heaviest version of each type.

OVERVIEW: CERAMAX WASHJET NOZZLES

- High pressure, even spray pattern at pressures above 300 psi (20 bar)
- Ceramic orifice insert made of aluminum oxide material provides longer wear life and greater corrosion resistance than hardened stainless steel
- Stainless steel nozzle body for better corrosion resistance than hardened stainless steel
- 1/4" NPT inlet connection
- Maximum working pressure: 4000 psi (276 bar)
- Spray impact is comparable to standard MEG nozzles

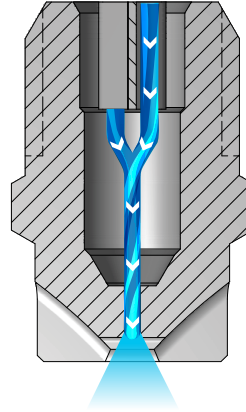

CERAMAX WashJet Nozzles

As the liquid exits through the rounded U shape of the orifice, it forms into a flat spray pattern. The distribution is even at pressures above 300 psi (20 bar).



CERMEG
1/4" male conn.

IDEAL FOR:

- Grill, rocker panel and wheel well cleaning

ORDERING INFORMATION

CERAMAX WASHJET CERMEG WITH GUIDE VANE

Nozzle Prefix	Inlet Conn.	Nozzle Type	—	Spray Angle	Capacity Size
Y	1/4	CERMEG	—	15	04

Example

BSPT connections require the addition of a "B" prior to the inlet connection.

CERAMAX WASHJET CERMEG WITHOUT GUIDE VANE

Nozzle Prefix	Inlet Conn.	Nozzle Type	—	Spray Angle	Capacity Size
YSA	1/4	CERMEG	—	15	04

Example

BSPT connections require the addition of a "B" prior to the inlet connection.

CERAMAX WEAR DATA

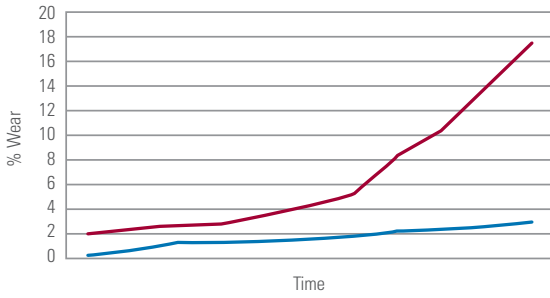

WEAR RATE

- Ceramic
- Hardened Stainless Steel



PERFORMANCE DATA:
STANDARD ANGLE SPRAY

Inlet conn. (in.)	Nozzle Type	Spray Angle			Capacity Size	Flow Rate Capacity (liters per minute)							
		15°	25°	40°		20 bar	35 bar	50 bar	80 bar	100 bar	140 bar	170 bar	200 bar
1/4	CERMEG	•	•	•	02	2.0	2.7	3.2	4.1	4.6	5.4	5.9	6.4
	CERMEG	•	•	•	025	2.5	3.4	4.0	5.1	5.7	6.7	7.4	8.1
	CERMEG	•	•	•	03	3.1	4.0	4.8	6.1	6.8	8.1	8.9	9.7
	CERMEG	•	•	•	04	4.1	5.4	6.4	8.2	9.1	10.8	11.9	12.9
	CERMEG	•	•	•	05	5.1	6.7	8.1	10.2	11.4	13.5	14.9	16.1
	CERMEG	•	•	•	06	6.1	8.1	9.7	12.2	13.7	16.2	17.8	19.3

DIMENSIONS AND WEIGHTS

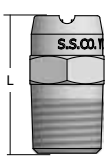
Nozzle	Nozzle Type	Inlet Conn. (in.)	L (mm)	Hex. (mm)	Net Weight (kg)
	CERMEG (M)	1/4	25.4	14	0.02

Based on largest/heaviest version of each type.



OVERVIEW: QUICK-CONNECT WASHJET NOZZLES

- High-impact flat-fan, spray pattern with uniform distribution
- Spray angles range from 0° to a 40° flat spray
- QCIMEG offers optimized fluid dynamics to minimize turbulence and maximize spray performance
- Incorporates the convenience of a quick connect/disconnect design
- Protective nozzle guards are color-coded for easy identification of spray angles
- Locating ribs on nozzle guards provide fast alignment and easy spray pattern direction
- Long wear life – hardened stainless steel
- An optional 302 stainless steel guide vane stabilizes turbulent flow and improves pattern quality and cleaning efficiency
- QCEM – Soap nozzle available in brass

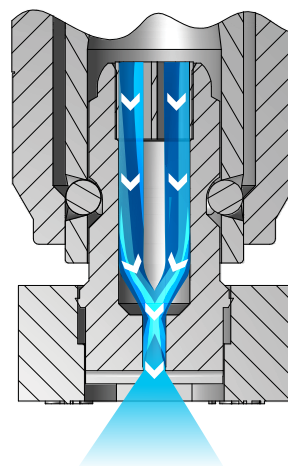

Quick-Connect WashJet Nozzles

As the liquid exits through the rounded U shape of the orifice, it forms into a flat spray pattern. The distribution is even at pressures above 300 psi (20 bar).

QUICK-CONNECT WASHJET NOZZLE OPTIONS



QCMEG
1/4" quick-connect



QCIMEG
1/4" quick-connect

IDEAL FOR:

- Grill, rocker panel and wheel well cleaning

QUICK-CONNECT WASHJET® NOZZLES

**HIGH PRESSURE
FLAT SPRAY**

ORDERING INFORMATION

QUICK-CONNECT WASHJET QCMEG AND QCIMEG WITH GUIDE VANE

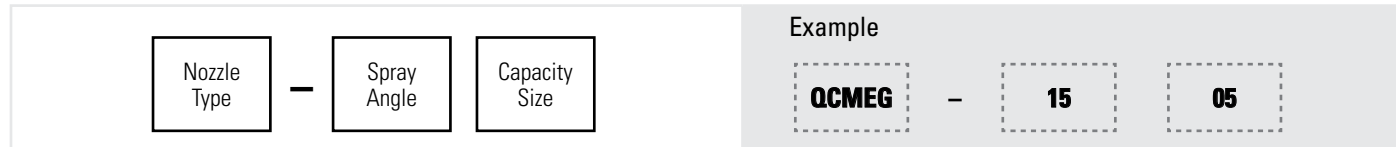

QUICK-CONNECT WASHJET QCMEG AND QCIMEG WITHOUT GUIDE VANE

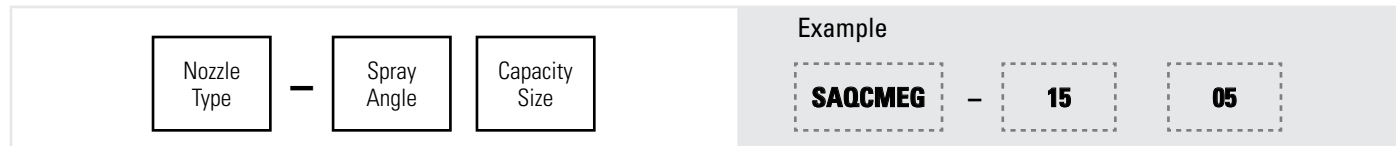

**PERFORMANCE DATA:
STANDARD ANGLE SPRAY**



Nozzle Type	Spray Angle at 3 bar				Capacity Size	Flow Rate Capacity (liters per minute)									
	0°* (Red)	15° (Yellow)	25° (Green)	40° (White)		20 bar	35 bar	50 bar	80 bar	100 bar	140 bar	170 bar	200 bar	250 bar	275 bar
•			•	•	02	2.0	2.7	3.2	4.1	4.6	5.4	5.9	6.4	7.2	7.6
•	•	•	•		03	3.1	4.0	4.8	6.1	6.8	8.1	8.9	9.7	10.8	11.3
•	•	•	•	•	035	3.6	4.7	5.6	7.1	8.0	9.4	10.4	11.3	12.6	13.2
•	•	•	•	•	04	4.1	5.4	6.4	8.2	9.1	10.8	11.9	12.9	14.4	15.1
•	•	•	•	•	045	4.6	6.1	7.3	9.2	10.3	12.1	13.4	14.5	16.2	17.0
•	•	•	•	•	05	5.1	6.7	8.1	10.2	11.4	13.5	14.9	16.1	18.0	18.9
•	•	•	•	•	055	5.6	7.4	8.9	11.2	12.5	14.8	16.3	17.7	19.8	21
•	•	•	•	•	06	6.1	8.1	9.7	12.2	13.7	16.2	17.8	19.3	22	23
•	•	•	•	•	065	6.6	8.8	10.5	13.3	14.8	17.5	19.3	21	23	25
•	•	•	•	•	07	7.1	9.4	11.3	14.3	16.0	18.9	21	23	25	26
•	•	•	•	•	075	7.6	10.1	12.1	15.3	17.1	20	22	24	27	28
•	•	•	•	•	08	8.2	10.8	12.9	16.3	18.2	22	24	26	29	30
•		•	•	•	09	9.2	12.1	14.5	18.3	21	24	27	29	32	34
•	•	•	•	•	10	10.2	13.5	16.1	20	23	27	30	32	36	38
•	•	•	•	•	12	12.2	16.2	19.3	24	27	32	36	39	43	45
•		•		•	15	15.3	20	24	31	34	40	45	48	54	57

*0° = Solid Stream.

**HIGH PRESSURE
FLAT SPRAY**

QUICK-CONNECT WASHJET® NOZZLES

**PERFORMANCE DATA:
STANDARD ANGLE SPRAY**

Nozzle Type	Spray Angle at 3 bar				Capacity Size	Flow Rate Capacity (liters per minute)									
	10° (Orange)	15° (Yellow)	25° (Green)	40° (White)		20 bar	35 bar	50 bar	80 bar	100 bar	140 bar	170 bar	200 bar	250 bar	275 bar
●			●	●	02	2.0	2.7	3.2	4.1	4.6	5.4	5.9	6.4	7.2	7.6
●	●	●	●	●	03	3.1	4.0	4.8	6.1	6.8	8.1	8.9	9.7	10.8	11.3
●	●	●	●	●	035	3.6	4.7	5.6	7.1	8.0	9.4	10.4	11.3	12.6	13.2
●	●	●	●	●	04	4.1	5.4	6.4	8.2	9.1	10.8	11.9	12.9	14.4	15.1
●	●	●	●	●	045	4.6	6.1	7.3	9.2	10.3	12.1	13.4	14.5	16.2	17.0
●	●	●	●	●	05	5.1	6.7	8.1	10.2	11.4	13.5	14.9	16.1	18.0	18.9
●	●	●	●	●	055	5.6	7.4	8.9	11.2	12.5	14.8	16.3	17.7	19.8	21
●	●	●	●	●	06	6.1	8.1	9.7	12.2	13.7	16.2	17.8	19.3	22	23
●	●	●	●	●	065	6.6	8.8	10.5	13.3	14.8	17.5	19.3	21	23	25
●	●	●	●	●	07	7.1	9.4	11.3	14.3	16.0	18.9	21	23	25	26
●	●	●	●	●	075	7.6	10.1	12.1	15.3	17.1	20	22	24	27	28
●	●	●	●	●	08	8.2	10.8	12.9	16.3	18.2	22	24	26	29	30
●		●	●	●	09	9.2	12.1	14.5	18.3	21	24	27	29	32	34

**PERFORMANCE DATA:
STANDARD ANGLE SPRAY**

Nozzle Type	Spray Angle at 3 bar			Capacity Size	Capacity (liters per minute)							
	25°	50°	65°		20 bar	35 bar	60 bar	80 bar	100 bar	140 bar	170 bar	200 bar
●	●		●	40	41	54	71	82	91	108	119	129
●		●		50	51	67	88	102	114	135	149	161

DIMENSIONS AND WEIGHTS

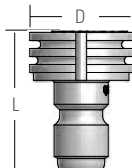
Nozzle	Nozzle Type	Length (mm)	Dia. (mm)	Net Weight (kg)
	QCMEG QCIMEG	31.0	24.6	0.02

Based on largest/heaviest version of each type.



OVERVIEW: VEEJET SPRAY NOZZLES

- Flat spray pattern distributes the liquid as a flat- or sheet-type spray
- Uniform distribution over a wide range of flow rates and pressures
- Spray angles available from 0° (solid stream) to 110° at 40 psi (3 bar)
- Specially tapered spray pattern is ideal for use in manifold and header applications
- Unobstructed flow passages minimize clogging
- Use 12686 strainer with H-1/8VV VeeJet nozzles and 12687 strainer for H-1/4VV VeeJet nozzles
- Maximum pressure is 500 psi (35 bar)

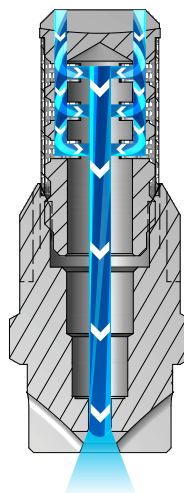

VeeJet Nozzles

As the liquid exits through the sharp V shape cut of the orifice, it forms into a flat spray pattern. The distribution is tapered from the center of the spray.

VEEJET NOZZLE OPTIONS



H-DT

1/8" to 1/4" female conn.
Flow rates below 1 gpm at 40 psi
(3.8 lpm at 2.8 bar)



H-DU

1/8" to 1/4" female conn.
Flow rates of 1 gpm and greater at 40 psi
(3.8 lpm and greater at 2.8 bar)



H-U

1/8" to 3/4" male conn.
Flow rates of 1 gpm and greater
at 40 psi
(3.8 lpm and greater at 2.8 bar)



H-VV

1/8" to 1/4" male conn.
Flow rates below 1 gpm at 40 psi
(3.8 lpm at 2.8 bar)
H-VV includes integral strainer



H-VVL

1/8" to 1/4" male conn.
Flow rates below 1 gpm at 40 psi
(3.8 lpm at 2.8 bar)
H-VVL includes integral strainer

IDEAL FOR:

- Chemical arches or anywhere spray nozzles are aligned to produce a uniform distribution

MATERIAL OPTIONS

Material	Code
Brass	(none)
303 Stainless Steel	SS

Other materials available upon request.

MESH GUIDE

Orifice Dia. (mm)	Recommended Screen Mesh
Up through .46	200
.47 through .79	100
.80 and larger	50



FLAT SPRAY

VEEJET® NOZZLES

ORDERING INFORMATION

VEEJET H-DT, H-DU, H-U, H-VV H-VVL

Nozzle Prefix	Inlet Conn.	Nozzle Type	—	Material Code	Spray Angle	Capacity Size
---------------	-------------	-------------	---	---------------	-------------	---------------

Example: **H** **1/4** **VV** — **SS** **110** **10**

BSPT connections require the addition of a "B" prior to the inlet connection.

VEEJET STRAINER

Strainer Type	—	Material Code	—	Mesh Size
---------------	---	---------------	---	-----------

Example: **12687** — **SS** — **100**

PERFORMANCE DATA:
STANDARD ANGLE SPRAY



Nozzle Type/ Inlet Conn. (in.)										Capacity Size	Equiv. Orifice Dia. (mm)	Capacity (liters per minute)						
H-VV		H-VVL		H-DT		H-DU		H-U				1.5 bar	3 bar	4 bar	6 bar	7 bar	15 bar	20 bar
1/8	1/4	1/8	1/4	1/8	1/4	1/8	1/4	1/8	1/4									
•	•	•	•	•						01	.66	.28	.39	.46	.56	.60	.88	1.0
•	•	•	•	•	•					02	.89	.56	.79	.91	1.1	1.2	1.8	2.0
•	•	•	•	•	•					03	1.1	.84	1.2	1.4	1.7	1.8	2.6	3.1
•	•	•	•	•	•					04	1.3	1.1	1.6	1.8	2.2	2.4	3.5	4.1
			•	•	•					045	1.3	1.3	1.8	2.1	2.5	2.7	4.0	4.6
•	•	•	•	•	•					05	1.4	1.4	2.0	2.3	2.8	3.0	4.4	5.1
•	•			•	•					055	1.5	1.5	2.2	2.5	3.1	3.3	4.9	5.6
•	•	•	•	•	•					06	1.5	1.7	2.4	2.7	3.4	3.6	5.3	6.1
•	•			•	•					065	1.6	1.8	2.6	3.0	3.6	3.9	5.7	6.6
•	•	•		•	•					07	1.7	2.0	2.8	3.2	3.9	4.2	6.2	7.1
•	•									075	1.7	2.1	3.0	3.4	4.2	4.5	6.6	7.6
•	•	•	•	•	•					08	1.8	2.2	3.2	3.6	4.5	4.8	7.1	8.2
•										085	1.8	2.4	3.4	3.9	4.7	5.1	7.5	8.7
•	•		•	•	•					09	1.9	2.5	3.6	4.1	5.0	5.4	7.9	9.2
•	•	•	•	•	•	•	•	•	•	10	2.0	2.8	3.9	4.6	5.6	6.0	8.8	10.2
•	•	•	•	•	•	•	•	•	•	15	2.4	4.2	5.9	6.8	8.4	9.0	13.2	15.3
						•	•	•	•	20	2.8	5.6	7.9	9.1	11.2	12.1	17.7	20
						•	•	•	•	30	3.4	8.4	11.8	13.7	16.8	18.1	26	31
						•	•	•	•	40	3.9	11.2	15.8	18.2	22	24	35	41
						•	•	•	•	50	4.4	14.0	19.7	23	28	30	44	51
						•	•		•	60	4.8	16.8	24	27	34	36	53	61
						•	•		•	70	5.2	19.5	28	32	39	42	62	71

Most capacities may be available in the following spray angles: 0°, 15°, 25°, 40°, 50°, 65°, 80°, 95° and 110°

Highlighted column shows the rated pressure.

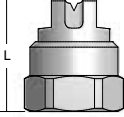
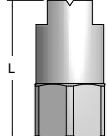
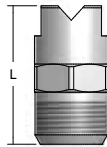

DIMENSIONS AND WEIGHTS

Nozzle	Nozzle Type	Inlet Conn. (in.)	Length (mm)	Hex. (in.)	Net Weight (kg)
	H-DT (F)	1/8	19.1	1/2	0.01
		1/4	19.8	5/8	0.02
	H-DU (F)	1/8	28.6	1/2	0.02
		1/4	28.6	5/8	0.04
	H-U (M)	1/8	25.4	9/16	0.01
		1/4	25.4	9/16	0.02

Based on largest/heaviest version of each type.

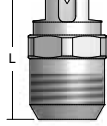
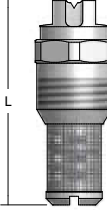
Nozzle	Nozzle Type	Inlet Conn. (in.)	Length (mm)	Hex. (in.)	Net Weight (kg)
	H-VV (M)	1/8	22.2	1/2	0.01
		1/4	23.0	9/16	0.02
	H-VVL (M)	1/8	38.9	1/2	0.02
		1/4	31.8	9/16	0.03

Based on largest/heaviest version of each type.



OVERVIEW: KYNAR® H1/4U VEEJET NOZZLES

- Color-coded for ease of spray angle identification
- Available in five angles: 25°, 40°, 50°, 65° and 80°
- Constructed of PVDF for excellent chemical resistance
- Nozzle body is standard 11/16" hex size and has a flange for easy installation and removal using a socket wrench
- Flats on the VeeJet nozzle facilitate proper alignment of spray pattern
- Optional removable strainer
- Use 12687 strainer for H1/4VV VeeJet nozzles



Kynar VeeJet Nozzles
 As the liquid exits through the sharp V shape cut of the orifice, it forms into a flat spray pattern. The distribution is tapered from the center of the spray.

KYNAR H1/4U VEEJET NOZZLE OPTIONS

 <p>H-U Green 25° 1/4" male conn.</p>	 <p>H-U White 40° 1/4" male conn.</p>	 <p>H-U Blue 50° 1/4" male conn.</p>
 <p>H-U Purple 65° 1/4" male conn.</p>	 <p>H-U Light Green 80° 1/4" male conn.</p>	

IDEAL FOR:

- Chemical arches or anywhere spray nozzles are aligned to produce a uniform distribution

MESH GUIDE

Nozzle Size (mm)	Recommended Screen Mesh
.51 and larger	50

Material Code (no material code = Brass;SS = 303 Stainless Steel)



ORDERING INFORMATION

KYNAR® H1/4U VEEJET

Nozzle Prefix	Inlet Conn.	Nozzle Type	Material Code	Spray Angle	Capacity Size
---------------	-------------	-------------	---------------	-------------	---------------

Example: **H** **1/4** **U** - **CKY** **65** **20**

BSPT connections require the addition of a "B" prior to the inlet connection.

PERFORMANCE DATA:
STANDARD ANGLE SPRAY



Inlet Conn. (in.)	Nozzle Type	Spray Angle at 3 bar					Capacity Size	Capacity (liters per minute)										
		H-U	25° Green	40° White	50° Blue	65° Purple		80° Light Green	0.4 bar	0.7 bar	1.5 bar	2 bar	3 bar	4 bar	6 bar	7 bar	15 bar	20 bar
1/4	•				•		10	1.4	1.9	2.8	3.2	3.9	4.6	5.6	6.0	8.8	10.2	13.5
	•	•	•	•	•	•	15	2.2	2.4	4.2	4.8	5.9	6.8	8.4	9.0	13.2	15.3	20
	•	•	•	•	•	•	20	2.9	3.8	5.6	6.4	7.9	9.1	11.2	12.1	17.7	20	27
	•			•	•	•	25	3.6	4.8	7.0	8.1	9.9	11.4	14.0	15.1	22	25	34
	•	•	•	•	•	•	30	4.3	5.7	8.4	9.7	11.8	13.7	16.8	18.1	26	31	40
	•		•	•	•	•	40	5.8	7.6	11.2	12.9	15.8	18.2	22	24	35	41	54
	•		•	•	•	•	50	7.2	9.5	14.0	16.1	19.7	23	28	30	44	51	67

Highlighted column shows the rated pressure.

MAXIMUM PRESSURES AT VARIOUS TEMPERATURES

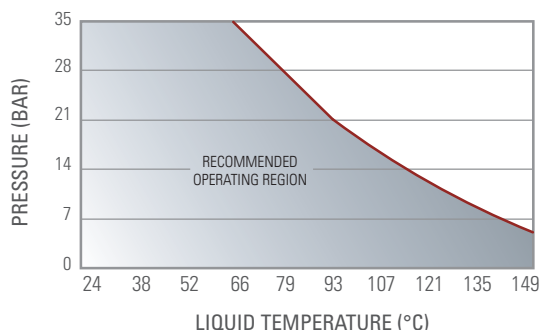

DIMENSIONS AND WEIGHTS

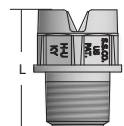
Nozzle	Nozzle Type	Inlet Conn. (in.)	L (mm)	D (Dia.) (mm)	Net Weight (kg)
	H-U (M)	1/4	25.4	22.2	0.01

Based on largest/heaviest version of each type.

OVERVIEW: KYNAR® H1/4VV VEEJET NOZZLES

- Color-coded for ease of spray angle identification
- Available in eight angles: 25°, 40°, 50°, 65°, 80°, 95°, 110° and 120°
- Constructed of PVDF for excellent chemical resistance
- Nozzle body is standard 7/16" hex size and has a flange for easy installation and removal using a socket wrench
- Flats on the VeeJet nozzle facilitate proper alignment of spray pattern
- Optional removable strainer
- Use 12687 strainer for H1/4VV VeeJet nozzles

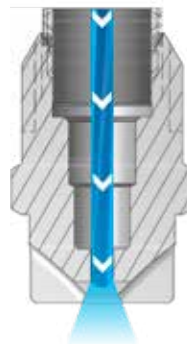

Kynar VeeJet Nozzles
As the liquid exits through the sharp V shape cut of the orifice, it forms into a flat spray pattern. The distribution is tapered from the center of the spray.

KYNAR H1/4VV VEEJET NOZZLE OPTIONS

 <p>H-VV Green 25° 1/4" male conn.</p>	 <p>H-VV White 40° 1/4" male conn.</p>	 <p>H-VV Blue 50° 1/4" male conn.</p>	 <p>H-VV Purple 65° 1/4" male conn.</p>
 <p>H-VV Light Green 80° 1/4" male conn.</p>	 <p>H-VV Grey 95° 1/4" male conn.</p>	 <p>H-VV Light Blue 110° 1/4" male conn.</p>	 <p>H-VV Light Purple 120° 1/4" male conn.</p>

IDEAL FOR:

- Chemical arches or anywhere spray nozzles are aligned to produce a uniform distribution

MESH GUIDE

Orifice Dia. (mm)	Recommended Screen Mesh
.25 through .51	100
.51 and larger	50

Material Code (no material code = Brass; SS = 303 Stainless Steel)

ORDERING INFORMATION

KYNAR® H1/4VV VEEJET

Nozzle Prefix	Inlet Conn.	Nozzle Type	—	Material Code	Spray Angle	Capacity Size
H	1/4	VV	—	CKY	65	06

Example
BSPT connections require the addition of a "B" prior to the inlet connection.

PERFORMANCE DATA:
STANDARD ANGLE SPRAY



Inlet Conn. (in.)	Nozzle Type	Spray Angle at 3 bar								Capacity Size	Capacity (liters per minute)										
		25° Green	40° White	50° Blue	65° Purple	80° Light Green	95° Gray	110° Light Blue	120° Light Purple		0.4 bar	0.7 bar	1.5 bar	2 bar	3 bar	4 bar	6 bar	7 bar	15 bar	20 bar	35 bar
1/4	H-VV	•	•		•	•				01	.14	.19	.28	.32	.39	.46	.56	.60	.88	1.0	1.3
	H-VV	•	•	•	•	•	•	•	•	02	.29	.38	.56	.64	.79	.91	1.1	1.2	1.8	2.0	2.7
	H-VV	•			•					025	.36	.48	.70	.81	.99	1.1	1.4	1.5	2.2	2.5	3.4
	H-VV	•	•	•	•	•	•	•	•	03	.43	.57	.84	.97	1.2	1.4	1.7	1.8	2.6	3.1	4.0
	H-VV	•		•	•	•	•	•	•	04	.58	.76	1.1	1.3	1.6	1.8	2.2	2.4	3.5	4.1	5.4
	H-VV	•		•	•	•	•	•	•	05	.72	.95	1.4	1.6	2.0	2.3	2.8	3.0	4.4	5.1	6.7
	H-VV	•	•	•	•	•	•	•	•	06	.86	1.1	1.7	1.9	2.4	2.7	3.4	3.6	5.3	6.1	8.1
	H-VV	•	•	•		•	•			07	1.0	1.3	2.0	2.3	2.8	3.2	3.9	4.2	6.2	7.1	9.4
	H-VV	•	•	•	•	•	•	•	•	08	1.2	1.5	2.2	2.6	3.2	3.6	4.5	4.8	7.1	8.2	10.8
	H-VV	•	•	•		•	•			10	1.4	1.9	2.8	3.2	3.9	4.6	5.6	6.0	8.8	10.2	13.5

Highlighted column shows the rated pressure.

MAXIMUM PRESSURES AT VARIOUS TEMPERATURES

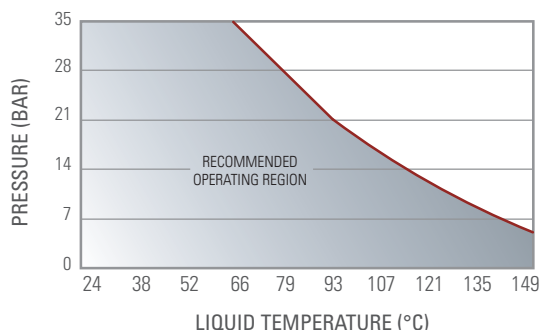

DIMENSIONS AND WEIGHTS

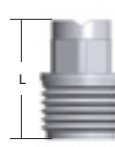
Nozzle	Nozzle Type	Inlet Conn. (in.)	L (mm)	D (Dia.) (mm)	Net Weight (kg)
	H-VV (M)	1/4	22.2	16	0.01

Based on largest/heaviest version of each type.

OVERVIEW: FLATJET SPRAY NOZZLES

- High-impact, flat spray pattern with narrow spray angle, sharply defined edges and uniform spray distribution
- Solid, one-piece design with deflector plane
- Large, unobstructed flow passage minimizes clogging
- Spray angles from 15° to 50°

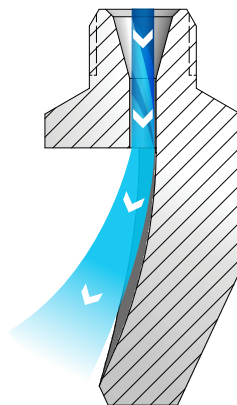

FlatJet Nozzles

As liquid passes through the nozzle, it hits the deflector surface and spreads out to form a flat spray pattern. The distribution is even from the center of the spray. The combination of medium to large flow rates and narrow spray angles produces a high-impact spray.



P
1/4" to 1/2" male conn.

IDEAL FOR:

- Rinse arches
- Presoak
- Use with recycled water
- Applications where adjacent spray patterns do not overlap

MATERIAL OPTIONS

Material	Code
Brass	(none)
Mild Steel	I
303 Stainless Steel	SS
316 Stainless Steel	316SS

Other materials available upon request.

ORDERING INFORMATION

FLATJET P

Inlet Conn.	Nozzle Type	—	Material Code	Spray Angle	Capacity Size
Example					
3/8	P	—	SS	50	60

BSPT connections require the addition of a "B" prior to the inlet connection.

PERFORMANCE DATA:
NARROW ANGLE SPRAY

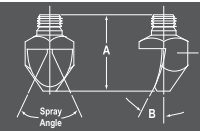

Spray Angle (°) at 3 bar	Nozzle Type	Inlet Conn. (in.)			Capacity Size	Equiv. Orifice Dia. (mm)	Flow Rate Capacity (liters per minute)						Spray Angle (°)			Dimensions			
		P	1/4	3/8			1/2	1 bar	1.5 bar	3 bar	6 bar	7 bar	10 bar	1 bar	3 bar	7 bar	A Length (mm)	B Deflection Angle (°)	C Bar Size (mm sq.)
50	●	●			05	1.3	1.1	1.4	2.0	2.8	3.0	3.6	33	50	60	31	60	15.9	.03
	●	●			10	1.9	2.3	2.8	3.9	5.6	6.0	7.2	34	50	60	31	60	15.9	.03
	●	●	●		25	3.0	5.7	7.0	9.9	14.0	15.1	18.0	42	50	59	41.5	42	19.1	.09
	●	●	●		40	3.8	9.1	11.2	15.8	22	24	29	39	50	60	47	45	19.1	.09
	●		●		60	4.6	13.7	16.8	24	34	36	43	42	50	53	55	37	25.4	.14
40	●		●		40	3.8	9.1	11.2	15.8	22	24	29	31	40	50	60.5	35	22.2	.14
	●		●		50	4.2	11.4	14.0	19.7	28	30	36	31	40	49	63.5	33	25.4	.20
	●		●		60	4.6	13.7	16.8	24	34	36	43	32	40	49	72	33	25.4	.23
35	●	●			10	1.9	2.3	2.8	3.9	5.6	6.0	7.2	18	35	39	36.5	36	15.9	.06
	●	●	●		20	2.7	4.6	5.6	7.9	11.2	12.1	14.4	24	35	40	42	30	19.1	.06
	●		●		25	3.0	5.7	7.0	9.9	14.0	15.1	18.0	24	35	39	49	28	19.1	.09
	●		●		30	3.3	6.8	8.4	11.8	16.8	18.1	22	26	35	41	52.5	28	19.1	.09
	●		●		40	3.8	9.1	11.2	15.8	22	24	29	28	35	38	58	26	22.2	.11
	●		●		50	4.2	11.4	14.0	19.7	28	30	36	31	35	38	63.5	23	22.2	.14
	●			●	60	4.6	13.7	16.8	24	34	36	43	29	35	39	73	27	25.4	.23
25	●	●			40	3.8	9.1	11.2	15.8	22	24	29	15	25	34	65	25	19.1	.11
15	●	●			10	1.9	-	2.8	3.9	5.6	6.0	7.2	-	15	23	47.5	22	15.9	.06
	●	●			20	2.7	-	5.6	7.9	11.2	12.1	14.4	-	15	19	54	19	15.9	.06
	●		●		30	3.3	6.8	8.4	11.8	16.8	18.1	22	6	15	24	72	25	19.1	.11
	●		●		40	3.8	9.1	11.2	15.8	22	24	29	8	15	21	92	18	22.2	.23
	●		●		50	4.2	11.4	14.0	19.7	28	30	36	9	15	20	90.5	15	22.2	.17
	●			●	60	4.6	13.7	16.8	24	34	36	43	10	15	19	125	14	25.4	.34

Highlighted column shows the rated pressure.



OVERVIEW: FLOODJET SPRAY NOZZLES

- Wide-angle, flat-fan spray pattern with uniform distribution and medium impact
- Precision engineered for dependable, accurate control of deflection and spray angle
- Orifice is protected from damage and is designed to minimize clogging

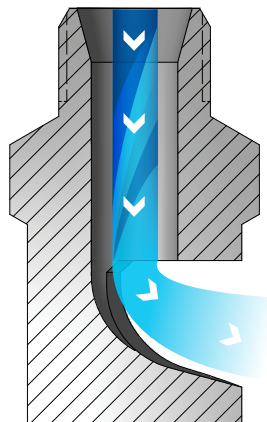

FloodJet Nozzles

As liquid passes through the nozzle, it hits the deflector surface and spreads out to form a flat spray pattern. The distribution is even from the center of the spray. The deflector surface enables the formation of wide spray angles compared to other flat spray nozzles.



K
1/8" to 1/2" (M)

IDEAL FOR:

- Presoak applications
- Final rinse applications
- Foam arches

MATERIAL OPTIONS

Material	Code
Brass	(none)
303 Stainless Steel	SS
316 Stainless Steel	316SS
Polyvinyl Chloride	PVC

Other materials available upon request.

ORDERING INFORMATION

FLOODJET K

Inlet Conn.	Nozzle Type	—	Material Code	Capacity Size	Example
1/8	K	—	SS	2	

BSPT connections require the addition of a "B" prior to the inlet connection.

**PERFORMANCE DATA:
WIDE ANGLE SPRAY**

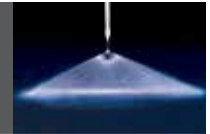

Nozzle Type	Inlet Conn. (in.)				Capacity Size	Equiv. Orifice Dia. (mm)	Flow Rate Capacity (liters per minute)							Spray Angle (°)		
	1/8	1/4	3/8	1/2			0.2 bar	0.5 bar	0.7 bar	1.5 bar	2 bar	3 bar	4 bar	0.5 bar	1.5 bar	4 bar
●	●	●			2	1.2	–	.64	.76	1.1	1.3	1.6	1.8	83	113	129
●	●	●			2.5	1.3	–	.81	.95	1.4	1.6	2.0	2.3	98	122	133
●	●	●			3	1.4	–	.97	1.1	1.7	1.9	2.4	2.7	86	112	126
●	●				4	1.7	–	1.3	1.5	2.2	2.6	3.2	3.6	97	123	132
●	●	●			5	1.9	1.0	1.6	1.9	2.8	3.2	3.9	4.6	114	128	142
●	●	●			7.5	2.3	1.5	2.4	2.9	4.2	4.8	5.9	6.8	101	119	134
●	●	●			10	2.7	2.0	3.2	3.8	5.6	6.4	7.9	9.1	115	133	145
●	●	●			12	2.9	2.4	3.9	4.6	6.7	7.7	9.5	10.9	128	139	153
●	●	●			15	3.3	3.1	4.8	5.7	8.4	9.7	11.8	13.7	98	113	123
●	●	●			18	3.6	3.7	5.8	6.9	10.1	11.6	14.2	16.4	106	120	131
●	●	●			20	3.8	4.1	6.4	7.6	11.2	12.9	15.8	18.2	110	122	133
●		●			22	3.9	4.5	7.1	8.4	12.3	14.2	17.4	20	113	125	136
●		●			24	4.1	4.9	7.7	9.2	13.4	15.5	19.0	22	115	131	144
●		●			27	4.4	5.5	8.7	10.3	15.1	17.4	21	25	119	135	148
●			●		30	4.6	6.1	9.7	11.4	16.8	19.3	24	27	100	110	121
●			●		35	5.0	7.1	11.3	13.3	19.5	23	28	32	105	118	128
●			●	●	40	5.3	8.2	12.9	15.3	22	26	32	36	111	126	136
●			●		45	5.6	9.2	14.5	17.2	25	29	36	41	115	130	140
●				●	50	5.9	10.2	16.1	19.1	28	32	39	46	117	131	140
●				●	60	6.5	12.2	19.3	23	34	39	47	55	120	134	142
●				●	70	7.0	14.3	23	27	39	45	55	64	123	137	146
●				●	80	7.5	16.3	26	31	45	52	63	73	127	138	149

Highlighted column shows the rated pressure.

DIMENSIONS AND WEIGHTS

Nozzle	Nozzle Type	Inlet Conn. (in.)	L (mm)	Hex. (in.)	Net Weight (kg)
	K	1/8	32.5	7/16	0.01
		1/4	34.1	9/16	0.03
		3/8	44.5	11/16	0.06
		1/2	50.8	7/8	0.11

Based on largest/heaviest version of each type.



OVERVIEW: UNIJET SPRAY NOZZLES

- Flat fan spray pattern with uniform distribution
- Spray angles available in 0°, 15°, 25°, 40°, 65°, 80° and 110°
- Save on nozzle replacement costs – bodies can be reused; only spray tips are replaced
- Design allows easy tip change-out in place – remove tips by unscrewing the retainer cap
- Recessed orifices to protect against damage
- T and TT bodies are compatible with FoamJet® spray tips (see page B27)

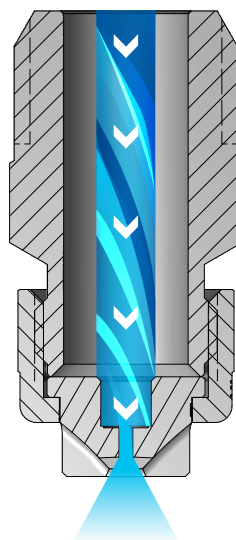

UniJet VeeJet® Nozzles

As the liquid exits through the sharp V shape cut of the orifice, it forms into a flat spray pattern. The distribution is tapered from the center of the spray.

UNIJET SPRAY NOZZLE OPTIONS

IDEAL FOR:

- Rinse applications

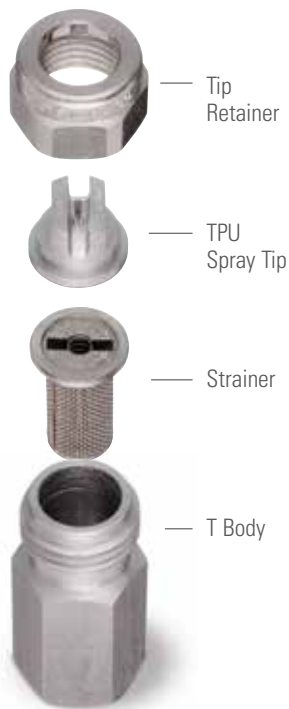

TPU Spray Tip + T Body

(TT) Use with screen strainer and tip retainer



TPU Spray Tip



TT Body
1/8" to 1/2" male conn.

MATERIAL OPTIONS

Material	Material Code	Spray Tip		
		TPU	T	TT
Brass	(none)	•	•	•
303 Stainless Steel	SS	•	•	•
Nylon	NYB		•	•

Other materials available upon request.



ORDERING INFORMATION

UNIJET TPU

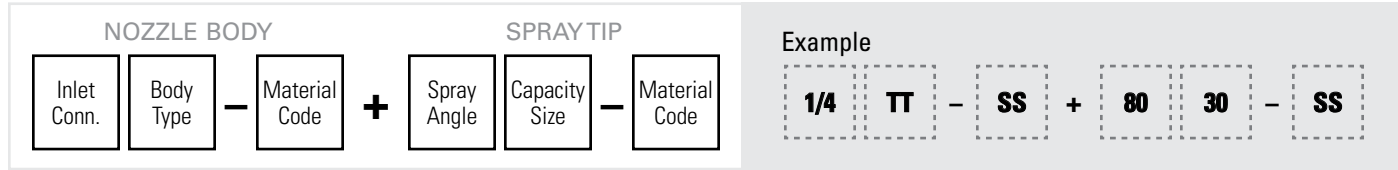

BSPT connections require the addition of a "B" prior to the nozzle body inlet connection.

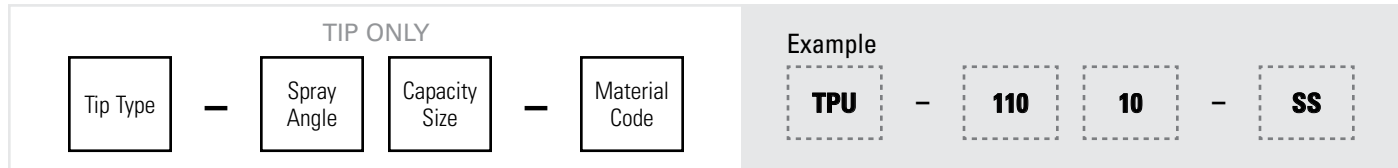

UniJet nozzle assemblies include a pre-sized wire mesh strainer based on orifice diameter. When ordering just a UniJet spray tip, the mesh is not included. See page B27 for mesh selection guide.

PERFORMANCE DATA: STANDARD ANGLE SPRAY

Tip Type	Capacity Size	Equiv. Orifice Dia. (mm)	Flow Rate Capacity (liters per minute)							
			0.7 bar	1.5 bar	2 bar	3 bar	4 bar	6 bar	7 bar	15 bar
TPU										
•	01	.66	.19	.28	.32	.39	.46	.56	.60	.88
•	015	.81	.29	.42	.48	.59	.68	.84	.90	1.3
•	02	.89	.38	.56	.64	.79	.91	1.1	1.2	1.8
•	03	1.1	.57	.84	.97	1.2	1.4	1.7	1.8	2.6
•	04	1.3	.76	1.1	1.3	1.6	1.8	2.2	2.4	3.5
•	045	1.4	.86	1.3	1.5	1.8	2.1	2.5	2.7	4.0
•	05	1.4	.95	1.4	1.6	2.0	2.3	2.8	3.0	4.4
•	06	1.6	1.1	1.7	1.9	2.4	2.7	3.4	3.6	5.3
•	07	1.7	1.3	2.0	2.3	2.8	3.2	3.9	4.2	6.2
•	08	1.8	1.5	2.2	2.6	3.2	3.6	4.5	4.8	7.1
•	09	1.9	1.7	2.5	2.9	3.6	4.1	5.0	5.4	7.9
•	10	2.0	1.9	2.8	3.2	3.9	4.6	5.6	6.0	8.8
•	12	2.2	2.3	3.4	3.9	4.7	5.5	6.7	7.2	10.6

Performance data for 95° spray angle. Contact your sales engineer for performance data for other spray angles.

Other body types may be available. Contact representative for further information.

Highlighted column shows the rated pressure.

DIMENSIONS AND WEIGHTS

Nozzle	Nozzle Type	Inlet Conn. (in.)	L (mm)	Hex. (in.)	Net Weight (kg)
	T (F) + TPU TT (M) + TPU	1/4	40.9	13/16	0.06

Based on the largest/heaviest version of each type.

OVERVIEW: FOAMJET® NOZZLES

- Produce highly aerated, lasting foam
- Made of chemical-resistant and durable material
- Plastic FoamJet nozzles have a color-coded insert for easy capacity identification
- FJP-VS and QJFJP produce a tapered-edge, flat spray pattern with even distribution – ideal for headers and manifolds where multiple nozzles are needed
- QJFJP offers easy installation and maintenance with quarter-turn automatic alignment
- QJFJP saves chemicals when used with blue color-coded check valve
- Body options are available in many quick-connect body assemblies for fast, easy maintenance



FOAMJET SPRAY TIP OPTIONS

FJ

- 0°, 40° or 80° spray angles
- Material: brass



COMPATIBLE BODIES

FJP-PP

- 20°, 40°, 65° or 80° spray angles
- Material: durable, chemically-resistant polypropylene
- Color-coded insert for easy capacity identification



COMPATIBLE BODIES

FJP-VS

- 40° or 80° spray angles
- Material: durable, chemically-resistant polypropylene
- With stainless steel orifice



COMPATIBLE BODIES















QJFJP

- 40° or 80° spray angles
- Easy installation and maintenance with quarter-turn automatic alignment
- Color-coded insert for easy capacity identification



COMPATIBLE BODIES

BODY OPTIONS

<p>● ● ● ● ●</p> <p>QJ7421-NYB</p> <p>Quick-connect nozzle body</p> <p>Fits 1/2", 3/4" or 1" pipe</p> <p>Outlet: QuickJet®</p> <p>Max pressure: 150 psi (10.4 bar)</p> <p>Nylon</p> 	<p>● ● ● ● ●</p> <p>7421</p> <p>Fits 1/2, 3/4" or 1" pipe</p> <p>Outlet: 11/16"-16 thread</p> <p>Max pressure: 150 psi (10.4 bar)</p> <p>Brass, 303 Stainless Steel</p> <p>Tip retainer choices: CP1325 or CP1325-SS</p> 	<p>● ● ● ● ●</p> <p>25775</p> <p>Fits 1/2", 3/4" or 1" pipe</p> <p>Outlet: 11/16"-16 thread</p> <p>Max pressure: 150 psi (10.4 bar)</p> <p>Nylon</p> <p>Tip retainer choices: CP18032-NYB or CP8027-NYB</p> 	<p>● ● ● ● ●</p> <p>8360-NY-BL</p> <p>Inlet: 1/4" (M) NPT/BSPT</p> <p>Outlet: 11/16"- 16" thread</p> <p>Max pressure: 125 psi (9 bar)</p> <p>Nylon</p> 
<p>● ● ● ● ●</p> <p>8360-1/4-NY-BL</p> <p>Quick-connect diaphragm check valve nozzle body</p> <p>Inlet: 1/4" (M) NPT/BSPT</p> <p>Outlet: 1/4" (F) NPT/BSPT</p> <p>Max pressure: 300 psi (20 bar)</p> <p>Nylon</p> 	<p>● ● ● ● ●</p> <p>8355-NY-BL</p> <p>Diaphragm check valve nozzle body</p> <p>Inlet: 1/4" or 1/8" (F) NPT/BSPT</p> <p>Outlet: 11/16" – 16" thread</p> <p>Max pressure: 125 psi (9 bar)</p> <p>Nylon</p> 	<p>● ● ● ● ●</p> <p>QJ8355-NY-BL</p> <p>Quick-connect diaphragm check valve nozzle body</p> <p>Inlet: 1/4" (F) NPT/BSPT</p> <p>Outlet: QuickJet</p> <p>Max pressure: 300 psi (20 bar)</p> <p>Nylon</p> 	<p>● ● ● ● ●</p> <p>QJ8360-NY-BL</p> <p>Quick-connect diaphragm check valve nozzle body</p> <p>Inlet: 1/4" (M) NPT/BSPT</p> <p>Outlet: QuickJet</p> <p>Max pressure: 300 psi (20 bar)</p> <p>Nylon</p> 
<p>● ● ● ● ●</p> <p>T</p> <p>Inlet: 1/4" (F) NPT/BSPT</p> <p>Outlet: 11/16" – 16 thread</p> <p>Max pressure: 300 psi (20 bar)</p> <p>Brass, 303 Stainless Steel, Nylon</p> <p>Tip retainer choices determined by material: For nylon, use CP18032-NYB or CP8027</p> 	<p>● ● ● ● ●</p> <p>TT</p> <p>Inlet: 1/4" (M) NPT</p> <p>Outlet: 11/16" – 16 thread</p> <p>Max pressure: 300 psi (20 bar)</p> <p>Brass, 303 Stainless Steel, Nylon</p> <p>Tip retainer choices determined by material: For nylon, use CP18032-NYB or CP8027</p> 	<p>● ● ● ● ●</p> <p>QJ1/4T-NYB</p> <p>Quick-connect diaphragm check valve nozzle body</p> <p>Inlet: 1/4" (M) NPT/BSPT</p> <p>Outlet: QuickJet</p> <p>Max pressure: 300 psi (20 bar)</p> <p>Nylon</p> 	<p>● ● ● ● ●</p> <p>QJ1/4TT-NYB</p> <p>Quick-connect diaphragm check valve nozzle body</p> <p>Inlet: 1/4" (F) NPT/BSPT</p> <p>Outlet: QuickJet</p> <p>Max pressure: 300 psi (20 bar)</p> <p>Nylon</p> 
<p>● ● ● ● ●</p> <p>QJ17560A-NY-BL</p> <p>Quick-connect diaphragm check valve nozzle body</p> <p>Fits 1/2", 3/4" or 1" pipe</p> <p>Outlet: QuickJet®</p> <p>Max pressure: 300 psi (20 bar)</p> <p>Nylon</p> 	<p>● ● ● ● ●</p> <p>QJ22187-NYB</p> <p>Quick-connect diaphragm side mounting valve nozzle body</p> <p>Fits 1/2", 3/4" or 1" pipe</p> <p>Outlet: QuickJet</p> <p>Nylon</p> 		

**SPECIALTY
SPRAY**

FOAMING

**PERFORMANCE DATA:
STANDARD ANGLE SPRAY**



Nozzle Type and Spray Angle									Capacity Size		Flow Rate Capacity (liters per minute)	
FJ			FJP-PP				QJFJP and FJP-VS		Orifice	Color†	3 bar	4 bar
0°	40°	80°	20°	40°	65°	80°	40°	80°				
			•	•	•	•	•	•	015	Green	.57	.68
			•	•	•	•	•	•	02	Yellow	.76	.91
	•		•	•	•	•	•	•	03	Blue	1.14	1.40
		•	•	•	•	•	•	•	04	Red	1.51	1.85
		•	•	•	•	•	•	•	05	Brown	1.89	2.31
•		•	•	•	•	•	•	•	06	Gray	2.27	2.76
•		•	•	•	•	•	•	•	08	White	3.03	3.71
•		•	•	•	•	•	•	•	10	Lt. Blue	3.79	4.62
•									15		5.68	6.81
•									20		7.57	9.46
•									25		9.46	11.73
•									30		11.36	14.01

†Color Inserts for FJP, QJFJP and FJP-VS Series.

DIMENSIONS AND WEIGHTS

Nozzle	Nozzle Type	Length (mm)	Net Weight (kg)
	FJ	45	0.03
	FJP-PP	39.5	0.01
	FJP-VS	38	0.01
	QJFJP	53	0.02

Based on largest/heaviest version of each type.

ORDERING INFORMATION

FOAMJET® TIP

<div style="border: 1px solid black; padding: 5px; display: inline-block;">Spray Tip</div> - <div style="border: 1px solid black; padding: 5px; display: inline-block;">Spray Angle</div> - <div style="border: 1px solid black; padding: 5px; display: inline-block;">Capacity Size</div> - <div style="border: 1px solid black; padding: 5px; display: inline-block;">Material Code</div>	<p>Example</p> <div style="border: 1px dashed gray; padding: 5px; display: inline-block; margin-right: 10px;">FJP</div> - <div style="border: 1px dashed gray; padding: 5px; display: inline-block; margin-right: 10px;">25</div> - <div style="border: 1px dashed gray; padding: 5px; display: inline-block; margin-right: 10px;">04</div> - <div style="border: 1px dashed gray; padding: 5px; display: inline-block;">PP</div>
---	--

BSPT connections require the addition of a "B" prior to the inlet connection.

FOAMJET BODY ASSEMBLY

<div style="border: 1px solid black; padding: 5px; display: inline-block; margin-right: 10px;">Nozzle Body Type</div> - <div style="border: 1px solid black; padding: 5px; display: inline-block; margin-right: 10px;">Material Code</div> - <div style="border: 1px solid black; padding: 5px; display: inline-block;">Check Valve Size</div>	<p>Example</p> <div style="border: 1px dashed gray; padding: 5px; display: inline-block; margin-right: 10px;">QJ8360</div> - <div style="border: 1px dashed gray; padding: 5px; display: inline-block; margin-right: 10px;">NY - BL</div> - <div style="border: 1px dashed gray; padding: 5px; display: inline-block;">2</div>
--	--

BSPT connections require the addition of a "B" prior to the inlet connection.



TIP RETAINERS

CP1325

Holds nozzle assembly together
 Inlet: 11/16"-16 female thread
 Material: Brass, stainless steel
 For high pressure applications,
 use 7890 tip retainer
 Order CP1325 when replacement
 is needed



CP8027-NYB

Holds nozzle assembly together
 Inlet: 11/16"-16
 female thread
 Material: Nylon



CP18032A-NYB

Holds nozzle assembly together
 Winged cap allows quick change
 of spray tips with no tool required
 Inlet: 11/16"-16
 female thread
 Material: Nylon



MATERIAL OPTIONS

Material	Material Code
Brass	(none)
Stainless Steel	SS
Nylon	NYB

Other materials available upon request.

QUICK-CONNECT RETAINERS

114445-4-CELR

Holds nozzle assembly together
 Use with FJ and FJP FoamJet® Nozzles
 Constructed of acetal (Celcon) for
 good strength and chemical resistance
 Max Pressure: 300 psi (20 bar)
 Standard gasket constructed of EPDM.
 Viton® is optional
 To order gasket separately use part number CP19438-VI or CP19438-EPR



114443-4-CELR

Holds nozzle assembly together
 Use with FJP FoamJet Nozzles
 Provides automatic alignment
 Constructed of acetal (Celcon) for
 good strength and chemical resistance
 Max Pressure: 300 psi (20 bar)
 Standard gasket constructed of EPDM. Viton is optional
 To order gasket separately use part number CP19438-VI or CP19438-EPR



ORDERING INFORMATION

RETAINERS



Example



**SPECIALTY
SPRAY**

VALVES/STABILIZERS

21950-10-NY-BL CHECK VALVE

- Easy installation and removal
- Corrosion-resistant

21950-10-NY-BL CHECK VALVE

Used with CP21953-EPR or VI diaphragm

Choice of opening pressures – 10 psi (0.7 bar), 15 psi (1 bar) or 20 psi (1.4 bar)

Max Pressure: 300 psi (20 bar)

Material: Nylon



JET STABILIZERS

- Install just before the spray nozzle to reduce fluid turbulence
- Helps reduce spray pattern flutter, increase fluid throw distance and increase impact force
- Ideal when nozzles are installed in 90° elbow forcing fluid to change direction
- For use with UniJet® flat spray and hollow cone nozzles

JET STRAINER OPTIONS

11370 Jet Stabilizer

1/8" x 1/8", 1/4" x 1/4", 3/8" x 3/8", 1/2" x 1/2", 3/4" x 3/4", 1" x 1", 1-1/4" x 1-1/4" male inlet conn./female outlet conn.

Materials: Brass, stainless steel



11950 Jet Stabilizer

Use with most standard UniJet® and Quick UniJet body assemblies

Materials: Brass, stainless steel
Stainless steel guide vane



MATERIAL OPTIONS

Material	Material Code
Brass	(none)
Stainless Steel	SS

Other materials available upon request.

ORDERING INFORMATION

CHECK VALVE



JET STABILIZERS



BSPT connections require the addition of a "B" prior to the inlet connection.



UNIJET® STRAINERS

- Use with most standard UniJet and Quick UniJet body assemblies
- In-line design for use at tip
- Low pressure loss
- Easy installation and removal
- Corrosion-resistant versions
- Pair most styles with CP4743 nylon gasket to prevent leaks

Note: Standard UniJet and Quick UniJet nozzles include a strainer. Mesh size is based on orifice diameter. Order strainers separately only if ordering replacement spray tip or if a special version is needed.

STRAINER OPTIONS

4514

One-piece design
Slotted design accommodates larger particulates
Materials: Brass or nylon with 16, 25 or 50 mesh equivalents; aluminum with 16 or 25 mesh equivalents



6051 303 stainless steel
5053 brass
8079 polypropylene
Mesh: 24, 50, 100 and 200



4193A

Built-in check valve
Stainless steel springs: opening pressures of 5, 10, 20 or 40 psi (0.35, 0.7, 1.5 or 2.8 bar)
Materials: Aluminum, brass, polypropylene, 303 stainless steel
Mesh: 24, 50, 100, and 200



7630

Disc design for use when space is extremely limited
Material: 303 stainless steel
Mesh: 30, 50, 100 and 200



4067

Cup design for use when space is limited
Material: 303 stainless steel
Mesh: 30, 50, 100 and 200



MATERIAL OPTIONS

Material	Material Code
Brass	(none)
Aluminum	AL
Nylon	NY
Stainless Steel	SS
Polypropylene	PP

Other materials available upon request.

MESH GUIDE

Orifice Dia. (mm)	Recommended Screen Mesh
Up through .46	200
.47 through .79	100
.80 and larger	50

ORDERING INFORMATION

STRAINER 5053, 6051 AND 8079

<div style="border: 1px solid black; padding: 5px; display: inline-block;">Strainer Type</div> - <div style="border: 1px solid black; padding: 5px; display: inline-block;">Material Code</div> - <div style="border: 1px solid black; padding: 5px; display: inline-block;">Mesh Size</div>	<p>Example</p> <div style="border: 1px dashed gray; padding: 5px; display: inline-block; margin-right: 10px;">6051</div> - <div style="border: 1px dashed gray; padding: 5px; display: inline-block; margin-right: 10px;">SS</div> - <div style="border: 1px dashed gray; padding: 5px; display: inline-block;">50</div>
--	--

STRAINER 4193A

<div style="border: 1px solid black; padding: 5px; display: inline-block;">Strainer Type</div> - <div style="border: 1px solid black; padding: 5px; display: inline-block;">Material Code</div> - <div style="border: 1px solid black; padding: 5px; display: inline-block;">Spring Opening Pressure (psi)</div> - <div style="border: 1px solid black; padding: 5px; display: inline-block;">Mesh Size</div>	<p>Example</p> <div style="border: 1px dashed gray; padding: 5px; display: inline-block; margin-right: 10px;">4193A</div> - <div style="border: 1px dashed gray; padding: 5px; display: inline-block; margin-right: 10px;">SS</div> - <div style="border: 1px dashed gray; padding: 5px; display: inline-block; margin-right: 10px;">5</div> - <div style="border: 1px dashed gray; padding: 5px; display: inline-block;">50SS</div>
---	--

STRAINER 4514

<div style="border: 1px solid black; padding: 5px; display: inline-block;">Strainer Type</div> - <div style="border: 1px solid black; padding: 5px; display: inline-block;">Material Code</div> - <div style="border: 1px solid black; padding: 5px; display: inline-block;">Slot Width</div>	<p>Example</p> <div style="border: 1px dashed gray; padding: 5px; display: inline-block; margin-right: 10px;">4514</div> - <div style="border: 1px dashed gray; padding: 5px; display: inline-block; margin-right: 10px;">NY</div> - <div style="border: 1px dashed gray; padding: 5px; display: inline-block;">10</div>
---	--

STRAINER 4067 AND 7630

<div style="border: 1px solid black; padding: 5px; display: inline-block;">Strainer Type</div> - <div style="border: 1px solid black; padding: 5px; display: inline-block;">Mesh Size</div>	<p>Example</p> <div style="border: 1px dashed gray; padding: 5px; display: inline-block; margin-right: 10px;">4067</div> - <div style="border: 1px dashed gray; padding: 5px; display: inline-block;">200</div>
---	---

DIMENSIONS AND WEIGHTS

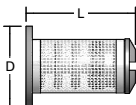
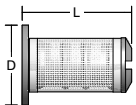
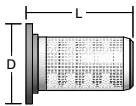
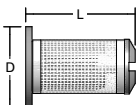
Strainer	Accessory Type	L (mm)	D (Dia.) (mm)	Net Weight (kg)
	5053	18.4	15.1	0.050
	6051	20.7	15.1	0.001
	8079	20.2	15.1	0.001
	4193A with check valve*	20.7	15.1	0.010

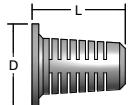
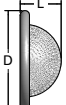
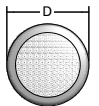
Strainer	Accessory Type	L (mm)	D (Dia.) (mm)	Net Weight (kg)
	4514	16.7	15.1	0.005
	4067	6.2	15.1	0.005
	7630	1.4	15.1	0.001

*Built-in check valve and stainless steel springs with opening pressures of 0.35, 0.7, 1.5 or 2.8 bar.



SPRAY GUNS

	PAGE
GunJet® and TriggerJet® Spray Guns	 C2
GunJet Spray Extensions	 C8
GunJet Swivel Connectors and Adapters	 C10



OVERVIEW: GUNJET AND TRIGGERJET SPRAY GUNS

- Sturdy design and materials, including nylon handles and trigger guards, forged brass valve bodies, Buna-N or Viton® stem seals, PTFE valve seats and stainless steel working parts, mean long and productive equipment life
- Ergonomic design assures positive control and operator comfort even at maximum flow and pressure conditions
- Optional “weep” feature (AA70, PW4000 and 30A) helps prevent freezing in cold conditions



AA70 GunJet

GUNJET SPRAY GUN OPTIONS

AA70

Max. operating pressure:
5000 psi (345 bar)
Max. temperature: 300°F (150°C)
Capacity: 10 gpm (38 lpm)
Material: Brass valve body with nylon handle
Trigger lock and guard
Designed to withstand high impact
Ergonomic design with light trigger pull
Large grip area to accommodate work gloves
Vented handle remains comfortable during hot spraying operations
Optional weep feature prevents freezing



PW4000AS

Max. operating pressure:
4000 psi (275 bar)
Max. temperature: 300°F (150°C)
Capacity: 10 gpm (38 lpm)
Material: Brass valve body with nylon handle
Trigger lock and guard
Designed to withstand high impact
Ergonomic design with light trigger pull
Bottom trigger pivot and inlet swivel rotate freely at high pressures
Handle remains comfortable during hot spraying operations



PW4000A

Max. operating pressure:
4000 psi (275 bar)
Max. temperature: 300°F (150°C)
Capacity: 10 gpm (38 lpm)
Material: Brass valve body with nylon handle
Trigger lock and guard
Designed to withstand high impact
Ergonomic design with light trigger pull
Handle remains comfortable during hot spraying operations



AA60

Max. operating pressure:
2500 psi (175 bar)
Max. temperature:
300°F (150°C)
Capacity: 6 gpm (23 lpm)
Material: Brass or stainless steel valve body with nylon handle
Trigger lock and guard
Designed to withstand high impact
Ergonomic design with light trigger pull
Front hose connection keeps grip cool



GUNJET® AND TRIGGERJET®

SPRAY GUNS

AA30A

Max. operating pressure:
1500 psi (105 bar)
Max. temperature: 200°F (93°C)
Capacity: 5 gpm (19 lpm)
Material: Brass valve body with
nylon handle
Trigger lock and guard
Designed to withstand high impact
Ergonomic design with
light trigger pull
Front hose connection keeps
grip cool
Optional weep feature prevents freezing



AA30L-PP

Max. operating pressure:
150 psi (10 bar)
Max. temperature:
120°F (8.3°C)
Capacity: 5 gpm (19 lpm)
Material: Brass or polypropylene
valve body with nylon handle
Trigger lock and guard
Light trigger pull
Front hose connection
keeps grip cool



AA30L

Max. operating pressure:
250 psi (17 bar)
Max. temperature:
200°F (93°C)
Capacity: 5 gpm (19 lpm)
Material: Brass valve body with
nylon handle
Trigger lock and guard
Light trigger pull
Front hose connection
keeps grip cool



MATERIAL OPTIONS

Material	Material Code
Brass	(none)
Polypropylene	PP
303 Stainless Steel	SS

ORDERING INFORMATION

COMPLETE SPRAY GUN ASSEMBLY



Example



BSPT connections require the addition of a "B".

SPECIFICATIONS

Model	Max. Operating Pressure (bar)	Capacity (lpm)	Max. Temperature (°C)	Inlet Conn. (in.)	Outlet Conn. (in.)	Weight (kg)	Spray Tips	Extensions	Adapters/ Swivel Connectors	Spare Parts Kits
AA70	345	38	150	3/8 NPT or BSPT (F)	1/4 NPT or BSPT (F)	.71	IMEG, MEG QCIMEG, WashJet	20400-1/8F	15950	—
PW4000A	275	38	150	1/4, 3/8 NPT or BSPT (F)	1/4, 3/8 NPT or BSPT (F)	.68	IMEG, MEG, MEG-SSTC, QCMEG WashJet	15250, 20400-1/4M*, 20400-1/8F*	9765, 15950, 21550	AB-PW4000A-KIT, AB-PW4000AW-KIT
PW4000AS	275	38	150	3/8 NPT or BSPT (F) swivel	1/4, 3/8 NPT or BSPT (F)	.68	IMEG, MEG, MEG-SSTC, QCMEG WashJet	15250, 20400-1/4M*, 20400-1/8F*	15950	AB-PW4000AS-KIT, AB-PW4000ASW-KIT
AA60	175	23	150	3/8 NPT or BSPT (F)	11/16–16 UniJet THD	.45	EG UniJet, MEG, MEG-SSTC WashJet®	9004-SS, 9702A, 9702C, 9702S, 20400-1/4M*, 20400-1/8F*	14643-1/4, 15950-SS	AB60-KIT, AB60-SS-KIT, AB60W-KIT, AB60-20250-KIT, AB60-21580-KIT, AB60-21580A-KIT, AB36533-60-KIT
AA30A	105	19	93	1/4 NPT or BSPT (F)	11/16–16 UniJet® THD	.43	EG, TG UniJet	9004-SS, 9702A, 9702C, 9702S, 13781S	4676-SS-1/4, 9765, 11990	AB30A-KIT, AB30AW-KIT, AB30A-50736-KIT
AA30L	17	19	93	1/4 NPT or BSPT (F)	11/16–16 UniJet® THD	.43	TB, TG, TK, TN, TPU, TX UniJet	4673, 6671, 6960, 7715, 9004-SS, 9527, 9702A, 9702C, 9702S, 12086, 13781S, 14975	4676, 20897	AB30L-KIT, AB30L-PP-KIT, AB30L-VI-KIT
AA30L-PP	10	19	8.3	1/4 NPT or BSPT (F)	11/16–16 UniJet® THD	.43	TB, TG, TK, TN, TPU, TX UniJet	4673, 6671, 6960, 7715, 9004-SS, 9527, 9702A, 9702C, 9702S, 12086, 13781S, 14975	4676, 20897	AB30L-KIT, AB30L-PP-KIT, AB30L-VI-KIT

*Use with adapter 14643-1/4-SSP or 14643-1/4-IENP.

Do not exceed the maximum operating pressure of the lowest rated accessory item within the spray system. Contact your sales engineer for additional configuration options.

See Spraying Systems Co. Hydraulic Spray Products Catalog 75 for spray tip performance data.



TRIGGERJET AND TRIGGER VALVE OPTIONS

AA36

Max. operating pressure: 150 psi (10 bar)
 Max. temperature: 140°F (60°C)
 Capacity: 7 gpm (27 lpm)
 Material: Brass or stainless steel valve body
 Trigger lock
 Internal strainer with choice of mesh sizes
 Quick acting "on-off" valve



6104

Max. operating pressure: 250 psi (17 bar)
 Max. temperature: 140°F (60°C)
 Capacity: 2 gpm (7.6 lpm)
 Material: Brass or stainless steel valve body
 Trigger lock
 Same as 4688 except with 1/4" NPT or BSPT (F) inlet and outlet connections



AA31

Max. operating pressure: 500 psi (35 bar)
 Max. temperature: 200°F (93°C)
 Capacity: 5 gpm (19 lpm)
 Material: Brass valve body
 Optional trigger lock
 Can be used with air
 Positive trigger action for drip-free shut off



6466

Max. operating pressure: 250 psi (17 bar)
 Max. temperature: 140°F (60°C)
 Capacity: 2 gpm (7.6 lpm)
 Material: Brass or stainless steel valve body
 Internal strainer with choice of mesh sizes
 Extra long trigger



4688

Max. operating pressure: 250 psi (17 bar)
 Max. temperature: 140°F (60°C)
 Capacity: 2 gpm (7.6 lpm)
 Material: Brass or stainless steel valve body
 Trigger lock
 Quick acting "on-off" valve
 Trigger designed for ease and comfort in operation



6590

Max. operating pressure: 250 psi (17 bar)
 Max. temperature: 140°F (60°C)
 Capacity: 2 gpm (7.6 lpm)
 Material: Brass or stainless steel valve body
 Trigger lock
 Extra long trigger



SPRAY GUNS

GUNJET® AND TRIGGERJET®

50800-PP-1/4

Max. operating pressure: 100 psi (7 bar)
 Max. temperature: 120°F (50°C)
 Capacity: 1.5 gpm (5.3 lpm)
 Material: Polypropylene valve body
 Trigger lock
 Polypropylene strainer located inside handle to prevent clogging.



50800-15-PP-1/4

Max. operating pressure: 100 psi (6.9 bar)
 Max. temperature: 120°F (50°C)
 Capacity: 1.5 gpm (5.3 lpm)
 Material: Polypropylene valve body
 Trigger lock
 Polypropylene strainer located inside handle to prevent clogging.



22650-PP

Max. operating pressure: 150 psi (10 bar)
 Max. temperature: 120°F (50°C)
 Capacity: 2 gpm (7.6 lpm)
 Material: Polypropylene valve body
 Trigger lock
 Corrosion-resistant lightweight design
 Choice of threaded or hose inlet connection
 UniJet® strainer option



22670-PP

Max. operating pressure: 150 psi (10 bar)
 Max. temperature: 120°F (50°C)
 Capacity: 2 gpm (7.6 lpm)
 Available with 15" or 24" extensions
 Material: Polypropylene valve body
 Trigger lock
 Corrosion-resistant lightweight design
 Choice of threaded or hose inlet connection
 UniJet® strainer option



MATERIAL OPTIONS

Material	Material Code
Aluminum	AL
Brass	(none)
Polypropylene	PP
Stainless steel	SS

ORDERING INFORMATION

COMPLETE SPRAY GUN ASSEMBLY



BSPT connections require the addition of a "B" in the prefix of the part number. Example: B22650-PP-1/4.







SPECIFICATIONS

Model	Max. Operating Pressure (bar)	Capacity (lpm)	Max. Temperature (°C)	Inlet Conn. (in.)	Outlet Conn. (in.)	Weight (kg)	Spray Tips	Extensions	Adapters/ Swivel Connectors	Spare Parts Kits
AA36	10	27	60	1/4, 3/8 NPT or BSPT (F)	1/4, 3/8 NPT or BSPT (F)	.32	HH FullJet®, VeeJet®	20400-1/4M, 20400-1/8F	4272, 4725, 4754, 5820	AB36-KIT, AB36-SS-KIT, AB36-21140-KIT
AA31	35	19	93	1/4 NPS (M) or NPT or BSPT (F)	11/16–16 UniJet THD	.35	EG, TB, TG, TK, TN, TP, TPU UniJet	6671-SS, 7715-SS, 9004-SS, 9527, 12086, 15699	4676, 7599, 8603, 8604, 11990, 14269, 14643	AB31-KIT, AB31-39430-KIT, AB31-9525-KIT, AB31-PGA-KIT
4688	17	7.6	60	1/4 NPT or BSPT (F)	11/16–16 UniJet THD	.14	TB, TG, TK, TN, TP, TPU, TX UniJet	4673, 6671, 9004-SS, 9527, 9702A, 9702C, 9702S, 12086, 13781S, 14975, 15699	4676	AB4688-KIT
6104	17	7.6	60	1/4 NPT or BSPT (F)	1/4 NPT or BSPT (F)	.14	FullJets, H-U, H-VV VeeJet	20400-1/4M, 20400-1/8F, CP12087	4676	AB6104-KIT
6466	17	7.6	60	1/4 NPT or BSPT (F)	11/16–16 UniJet THD	.14	TB, TG, TK, TN, TP, TPU, TX UniJet	4673, 6671, 9004-SS, 9527, 9702A, 9702C, 9702S, 12086, 13781S, 14975, 15699	4676	AB6466-KIT
6590	17	7.6	60	1/4 NPT or BSPT (F)	1/4 NPT or BSPT (F)	.16	FullJets, H-U, H-VV VeeJet	20400-1/4M, 20400-1/8F, CP12087	4676	AB6590-KIT
22650-PP	10	7.6	50	1/4, 3/8 hose or 1/4 NPT or BSPT (F)	11/16–16 UniJet THD	.08	5500-PPB ConeJet	22665	22664, 22673	AB22650-PP-KIT
22670-PP	10	7.6	50	1/4, 3/8 hose or 1/4 NPT or BSPT (F)	11/16–16 UniJet THD		5500-PPB ConeJet	22665	22664, 22673	AB22650-PP-KIT
50800-PP-1/4	6.9	1.5	50	1/4, 3/8 hose or 1/4 NPT or BSPT (F)	11/16–16 UniJet THD	.14	38720-PPB ConeJet®	—	AB50800 1/4"	—
50800-15-PP-1/4	6.9	1.5	50	1/4 NPT or BSPT Adapter	11/16–16 UniJet THD		38720-PPB ConeJet®	—	AB50800 1/4"	—

Do not exceed the maximum operating pressure of the lowest rated accessory item within the spray system. Contact your sales engineer for additional configuration options. See Spraying Systems Co. Hydraulic Spray Products Catalog 75A for spray tip performance data.





SPRAY GUN EXTENSIONS

Extension	Extension No.	Max. Pressure (bar)	Inlet Conn. (in.)	Outlet Conn. (in.)	Material	Lengths (mm)	Special Features
	9004-SS	275	11/16–16 UniJet THD	11/16–16 UniJet THD	Stainless steel	203	
						305	
						457	
						610	
						914	
	20400-1/4M	207	1/4 NPT or BSPT (M)	1/4 NPT or BSPT (M)	Stainless steel or zinc-plated steel	457	Neoprene insulated cover
						914	
	20400-1/8F	207	1/4 NPT or BSPT (M)	1/8 NPT or BSPT (F)	Stainless steel or zinc-plated steel	457	Neoprene insulated cover
						914	
	15699	69	11/16–16 UniJet THD	11/16–16 UniJet THD	Brass	203	Rubber insulated (203 mm length not rubber insulated)
						457	
						610	
						914	
	9527	69	11/16–16 UniJet THD	11/16–16 UniJet THD	Brass	203	Curved, rubber insulated
						457	
						610	
						914	
	12086	69	11/16–16 UniJet THD	11/16–16 UniJet THD	Aluminum with brass ferrules	203	
						457	
						610	
						914	
	7715	35	11/16–16 UniJet THD	11/16–16 UniJet THD	Stainless steel	203	
						305	
						457	
						610	
						762	
						914	
	17	11/16–16 UniJet THD	11/16–16 UniJet THD	Brass	203		
					305		
					457		
					610		
					762		
					914		
1219							

GUNJET® SPRAY EXTENSIONS

SPRAY GUNS

Extension	Extension No.	Max. Pressure (bar)	Inlet Conn. (in.)	Outlet Conn. (in.)	Material	Lengths (mm)	Special Features
	22665	10	11/16–16 UniJet THD	11/16–16 UniJet THD	Polyester	381	
						610	
	6671	8.6	11/16–16 UniJet THD	11/16–16 UniJet THD	Brass (914 mm lengths also available in stainless steel)	203	Curved body
						457	
						610	
						762	
						914	
						1219	

Do not exceed the maximum operating pressure of the lowest rated accessory item within the spray system. Contact your sales engineer for additional options.

MATERIAL OPTIONS

Material	Material Code
Aluminum	AL
Brass	(none)
Stainless steel	SS
Zinc-plated steel	IZP

ORDERING INFORMATION

<div style="border: 1px solid black; padding: 5px; width: 80px; margin: 0 auto;">Extension Type</div> — <div style="border: 1px solid black; padding: 5px; width: 80px; margin: 0 auto;">Extension Length</div> — <div style="border: 1px solid black; padding: 5px; width: 80px; margin: 0 auto;">Material Code</div>	<p>Example</p> <div style="display: flex; justify-content: center; align-items: center; gap: 10px;"> <div style="border: 1px dashed gray; padding: 5px; width: 60px; text-align: center;">7715</div> — <div style="border: 1px dashed gray; padding: 5px; width: 60px; text-align: center;">18</div> — <div style="border: 1px dashed gray; padding: 5px; width: 60px; text-align: center;">SS</div> </div>
--	---

CONNECTOR AND ADAPTER OPTIONS

Connector	Type	Max. Pressure (bar)	Max. Temperature (°C)	Inlet Conn. (in.)	Outlet Conn. (in.)	Material	Special Features
	8510 strainer	275	93	1/4 NPS (M)	1/4 NPS (F)	Stainless steel	Choice of screen mesh sizes. Internal support prevents screen collapse at high pressure.
	9765	275	93	1/4 NPS (M)	1/4 NPS (F)	Stainless steel & Delrin® bearings	
	36560 swivel	138	93	3/8 NPT (M)	3/8 NPS (F)	Nickel-plated brass	Boom swivel designed for ceiling mount.
	21550-90NP	103	93	1/4, 3/8 NPT (M)	3/8 NPT or BSPT (F)	Delrin® bearings and Buna-N O-ring	Ceiling-mount.
	21550 swivel	103	93	1/4, 3/8 NPT or BSPT (F)	1/4, 3/8 NPT or BSPT (M)	Brass	Self-lubricating PTFE-filled bearings
	15950 swivel	69	93	3/8 NPT or BSPT (M)	3/8 NPT or BSPT (F)	Brass	Allows swiveling under pressure and side loads

GUNJET® SWIVEL CONNECTORS AND ADAPTERS

SPRAY GUNS

Connector	Type	Max. Pressure (bar)	Max. Temperature (°C)	Inlet Conn. (in.)	Outlet Conn. (in.)	Material	Special Features
	11990 In-line swivel	69	82	1/4 to 1/2 NPT or BSPT (F), 1/4 to 1/2 NPT or BSPT (M)	1/4 NPS (M), 1/4 to 1/2 NPT or NPS (F)	Brass	Leakproof hose, 360° swivel eliminates hose kinking and operator fatigue.
	13212	10.4	–	3/4 garden hose thread (F)	3/8, 1/2 NPT or BSPT (M)	Brass	
	14269	8.6	–	3/4 garden hose thread (F)	1/4 NPS (F) or 1/4 NPT (F)	Brass	
	14643	275	–	11/16–16 THD (F)	1/8, 1/4" NPT or BSPT (F)	Nickel-plated steel or stainless steel	
	4676	138	–	11/16–16 THD (F)	1/8, 1/4, 3/8, 1/2, 3/4 NPT or BSPT (F)	303 Stainless Steel	
		69	–	11/16–16 THD (F)	1/8, 1/4, 3/8, 1/2, 3/4 NPT or BSPT (F)	Brass and nickel-plated brass	
		8.6	–	11/16–16 THD (F)	1/8, 1/4, 3/8, 1/2, 3/4 NPT or BSPT (F)	Nylon	

Do not exceed the maximum operating pressure of the lowest rated accessory item within the spray system. Contact your sales engineer for additional options.

MATERIAL OPTIONS

Material	Material Code
Brass	(none)
Nickel-plated brass	NP
Stainless steel	SS
Nylon	NYB



ORDERING INFORMATION

OUTLET ADAPTER



BSPT connections require the addition of a "B" in the prefix of the part number. Example: B15950.

SPRAY GUN CONNECTORS

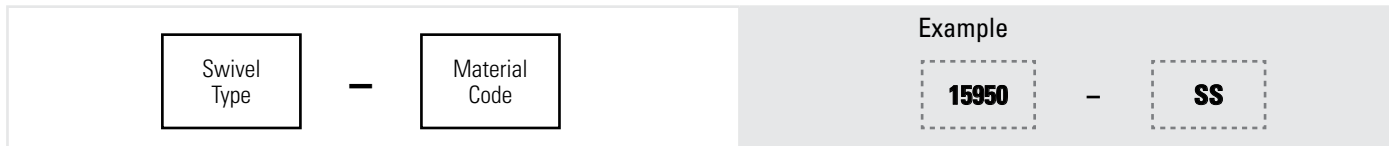

BSPT connections require the addition of a "B" in the prefix of the part number. Example: B15950.

SPRAY GUN CONNECTORS



BSPT connections require the addition of a "B" in the prefix of the part number. Example: B15950.

11990 DIMENSIONS

Connection Type	Swivel Ordering No.	Connection Thread Sizes (NPT/BSPT or NPS in.)		Approx. Overall Length (mm)
Female x Female	11990-7	1/4 (F) NPT/BSPT	1/4 (F) NPT/BSPT	52
	11990-20	3/8 (F) NPT/BSPT	1/4 (F) NPS	44
Male x Male	11990-8	1/4 (M) NPT/BSPT	1/4 (M) NPT/BSPT	57
	11990-13	1/4 (M) NPT/BSPT	1/4 (M) NPS	57
	11990-15	3/8 (M) NPT/BSPT	3/8 (M) NPT/BSPT	59
	11990-18	1/2 (M) NPT/BSPT	1/2 (M) NPT/BSPT	70
Male x Female	11990-9	1/4 (M) NPT/BSPT	1/4 (F) NPT/BSPT	56
	11990-21	3/8 (M) NPT/BSPT	1/4 (F) NPS	51

11990 WITH HOSE SHANK DIMENSIONS

Connection Type	Swivel Ordering No.	Connections		Approx. Overall Length (mm)	For Hose ID (mm)
		Thread Sizes NPT/BSPT or NPS in.	Shank Dia. (mm)		
Female x Hose Shank	11990-60	1/4 (F) NPS	7.1	67	6
Male x Hose Shank	11990-62	1/4 (M) NPT/BSPT	7.1	59	6
	11990-63	1/4 (M) NPS	7.1	60	6
	11990-64	1/4 (M) NPT/BSPT	10.3	63	10





AIR NOZZLES

PAGE

AA727 WindJet® Nozzles

 D2

AA707 WindJet Nozzles

 D2



OVERVIEW: WINDJET AIR NOZZLES

- Air nozzles convert a low-pressure volume of compressed air into a targeted high-velocity concentrated air stream, flat-fan or curtain of high-impact air
- A significant reduction in compressed air consumption compared to open pipes
- Improved safety. The design of WindJet air nozzles prevents dead-ending should the nozzle accidentally be placed against a flat surface
- The targeted air stream delivered by the nozzles can improve the effectiveness and efficiency of drying and blow-off



WINDJET NOZZLE OPTIONS

AA727

Generate efficient, controlled flat fan air pattern for a uniform spray distribution
 Designed to maintain spray pattern integrity
 Recessed orifices protect against external damage and offer air escape should the nozzles accidentally be placed against a flat surface
 Low noise levels
 Can be mounted side-by-side for air curtain applications
 1/4" NPT or BSPT (M) ABS or PPS
 1/4" NPT or BSPT (F) ABS only



AA707

Produce tightly directed, round spray pattern
 Low noise levels
 Color-coded aluminum caps for easy identification of flow rates
 Recessed orifices
 1/4" NPT or BSPT (M) ABS or PPS



IDEAL FOR:

- Drying door handles
- Drying mirrors
- Window trim

SPECIFICATIONS

Nozzle Type	Connection	Conn. Size (in.)	Materials	Max. Operating Temperature (°C)
AA727	M	1/4	Polyphenylene sulfide (RY) Aluminum (AL)	At 7 bar 82 230
	M or F	1/4	ABS plastic	At 7 bar 77
	M	1/4	Stainless steel (SS)	At 10.3 bar 260
AA707	M	1/4	Polyphenylene sulfide (RY) PVDF (KY) Aluminum (AL) Stainless steel (SS) ABS plastic	At 8.6 bar 204 104 230 230 82

ORDERING INFORMATION

WINDJET AIR NOZZLES

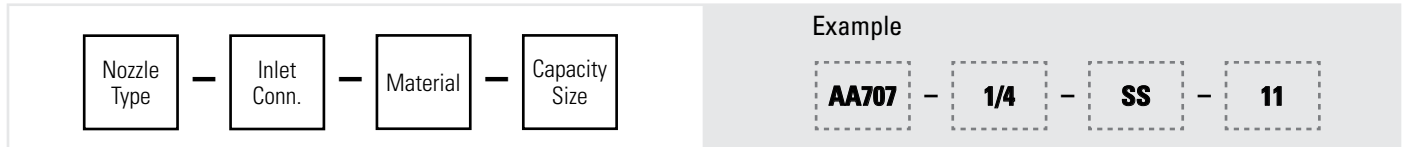

BSPT connections require the addition of a "B".

PERFORMANCE DATA:
STANDARD ANGLE SPRAY

Nozzle Type	Inlet Conn. (in.)	Capacity Size	Cap Color (Aluminum Only)	Air Consumption Capacity (normal liter per minute)			
				0.7 bar	2 bar	4 bar	6 bar
AA727	1/4 (M, F)	11	—	142	246	396	549
		15	—	193	357	586	816
		23	—	280	510	852	1198
AA707	1/4 (M)	11	green	147	266	442	612
		15	yellow	181	345	578	810
		23	red	294	530	889	1237

DIMENSIONS AND WEIGHTS

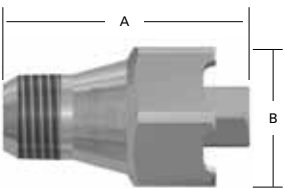
NozzleType	Nozzle Type	A (mm)	B (mm)	Net Weight (kg)
	AA727 (M)	91	51	0.12
	AA727 (F)	91	51	0.02
	AA707 (M)	48	25	0.05

Based on largest/heaviest version of each type.



ACCESSORIES

	PAGE
Siphon Injectors	 E2
Adjustable Ball Fittings	 E3
Check Valves	 E4
Throttling and Pressure Relief/Regulating Valves	 E5



ACCESSORIES

SIPHON INJECTORS

50580 ADJUSTABLE SIPHON INJECTOR

- Provides the flexibility to easily adjust and lock in different mixture ratios
- Numbered index adjustment screw enables measured and repeatable siphon control
- Lock-nut to secure settings from system vibrations
- Needle valve design to ensure precise control of flow
- Easy-open, check-valve design on siphon inlet
- Flow range: 0.5 to 6.0 gpm (1.9 to 22.7 lpm)
- Request Data Sheet 50580 for flow capacity information



50580 Adjustable Siphon Injector

13340 FIXED SIPHON INJECTOR

- Calibrated to provide proper siphoning when matched with system flow rates
- Easy-open, check-valve design on siphon inlet
- Request Data Sheet 13340 for specific siphon rate information



13340 Fixed Siphon Injector

SPECIFICATIONS

Model Number	Max. Pressure (bar)	Inlet Connection (in.)	Outlet Connection (in.)	Siphon Inlet Connection (in.)	Max. Temperature (°C)	Approximate Weight (kg)	Material
50580	275	3/8" or 1/2" NPT or BSPT (F)	3/8" or 1/2" NPT or BSPT (M)	.281" Dia. Hose Barb or 1/4" NPT or BSPT (M)	150	0.22	Brass
13340	275	3/8" or 1/2" NPT or BSPT (F)	3/8" or 1/2" NPT or BSPT (M)	.281" Dia. Hose Barb or 1/4" NPT or BSPT (M)	150	0.18	Brass

Other materials available upon request.

ORDERING INFORMATION

50580 ADJUSTABLE SIPHON INJECTOR



50580 ADJUSTABLE SIPHON INJECTOR



FIXED SIPHON INJECTOR



BSPT connections require the addition of a "B" prior to the inlet connection.



BALL FITTINGS

- Allow positioning of spray for more exact control of spray direction and reduced over-spraying
- Smooth finished surfaces assure leak-proof connections

MATERIAL OPTIONS

Material	Code
Brass	(none)
303 Stainless Steel	SS
316 Stainless Steel	316SS

If inlet and outlet connections are different sizes, material options are brass or 303 Stainless Steel. Other materials available upon request.

BALL FITTING OPTIONS

36275 Adjustable Ball

1/8" to 3/4" male inlet conn./ female outlet conn. NPT or BSPT

Max. pressure: 300 psi (20 bar)

Materials: Brass, 303 and 316 stainless steel



37235

1/4" to 1/2" inlet male conn. NPT

Max. pressure: 125 psi (9 bar)

Max. temperature: 180° (82°C)

Materials: ProMax® body with polyphthalamide cap and EPDM rubber o-ring (Viton® optional)

Shown with CT_40 Clip-Eyelet® tip additional tips are available



SPECIFICATIONS

Model Number	Inlet Conn. (in.)	Outlet Conn. (in.)	Total Included Angle of Adjustment	L (mm)	D (Dia.) (mm)	Hex. (in.)	Net Weight (kg)
36275	1/8	1/8	45°	34.9	24.6	7/8	0.06
	1/4	1/4		39.7	27.8	1	0.09
	1/4	1/8		39.7	27.8	1	0.09
	3/8	3/8		45.2	27.6	1-1/4	0.16
	3/8	1/4		56.4	42	1-1/4	0.29
	1/2	1/2		61.1	48.4	1-1/2	0.49
	1/2	1/4		47.6	34.9	1-1/2	0.29
	1/2	3/8		47.6	34.9	1-1/2	0.16
	3/4	3/4		61.1	48.4	1-7/8	0.50

ORDERING INFORMATION

36275 ADJUSTABLE BALL FITTING



BSPT connections require the addition of a "B" prior to the inlet connection.

ACCESSORIES

CHECK VALVES

CHECK VALVES

- Positive, drip-free shut-off maintains line pressure during on/off spraying cycles
- Minimal pressure drop through CV and diaphragm valves
- Prevent back flow
- Viton® O-ring soft-seat provides positive seal – no leakage
- For more information, request Data Sheet 12527

MATERIAL OPTIONS

Material	Code
Brass	No code
Nylon (12328 Only)	NYB
303 stainless steel	SS

SPECIFICATIONS

Check Valve	Maximum Pressure (bar)	Maximum Flow Rate (l/min)	Spring Rates	Opening Pressure (bar)	Inlet Connection (in.)	Outlet Connection (in.)
AACV	10	8	0.35, 0.7 or 1.5 bar	–	1/8 or 1/4 NPT or BSPT (F)	1/8 or 1/4 NPT or BSPT (F)
BACV	10	8	0.35, 0.7 or 1.5 bar	–	1/8 or 1/4 NPT or BSPT (M)	1/8 or 1/4 NPT or BSPT (F)
ABCV	10	8	0.35, 0.7 or 1.5 bar	–	1/8 or 1/4 NPT or BSPT (F)	1/8 or 1/4 NPT or BSPT (M)
BBCV	10	8	0.35, 0.7 or 1.5 bar	–	1/8 or 1/4 NPT or BSPT (M)	1/8 or 1/4 NPT or BSPT (M)
12328	9	57	–	0.5	1/2 or 3/4 NPT or BSPT (M)	1/2 or 3/4 NPT or BSPT (F)

ORDERING INFORMATION

CV SERIES CHECK VALVE

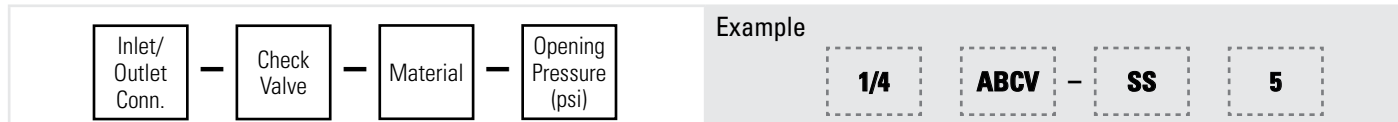

BSPT connections require the addition of a "B" prior to the inlet connection. Opening pressure is ordered in psi.

12328 DIAPHRAGM CHECK VALVE

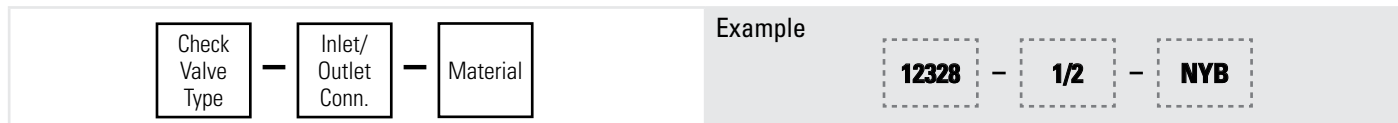

BSPT connections require the addition of a "B" prior to the inlet connection.

OPTIONS

CV Series

- AACV 1/8", 1/4" female inlet and female outlet conn.
- BACV 1/8", 1/4" male inlet and female outlet conn.
- ABCV 1/8", 1/4" female inlet and male outlet conn.
- BBCV 1/8", 1/4" male inlet and male outlet conn.



12328 Diaphragm

- 1/2", 3/4" male inlet and female outlet conn.
- Max. flow rate: 15 gpm (57 lpm)
- 7 psi (0.5 bar) opening pressure
- Material: Nylon



THROTTLING AND PRESSURE RELIEF/REGULATING VALVES

- Easily regulate flow in systems using centrifugal pumps with throttling valves; adjustable cap and lock ring provide easy valve control
- Control line pressure and minimize liquid waste with adjustable relief valves that return excess liquid back to the liquid source or pump inlet

PRESSURE RELIEF VALVE OPTIONS

23120

Polypropylene body with nylon adjusting cap means excellent chemical resistance
Easily, hand-adjustable pressure relief valve
Maintain line pressure with adjustable locknut
1/2", 3/4" male inlet and female outlet conn
Material: Polypropylene



8460

1/2", 3/4" male inlet and female bypass conn.
Diaphragm-style pressure relief valve
Female pressure gauge port and plug for use when pressure gauge not used
Fairprene® diaphragm seal prevents fluid from working parts
Materials: Aluminum housing with nylon body



9840

Diaphragm-style pressure relief valve
Fairprene® diaphragm seal prevents fluid from working parts and provides responsive, chatter-free operation
Additional port for pressure gauge installation
Materials: Aluminum and brass housing with nylon body



6815

1/2", 3/4" male inlet and female outlet conn.
Piston-type pressure relief valve
Free-floating design improves speed and sensitivity
Full flow with minimum pressure loss due to extra large valve passage
Materials: Aluminum, brass, hardened stainless steel



110

1", 1-1/4", 1-1/2" conn.
Piston-type pressure relief valve
Guide vane seat stabilizes flow for vibration reduction
Free-floating design improves speed and sensitivity
Full flow with minimum pressure loss due to extra-large valve passage
Removable valve bonnet: no disturbance of fluid line connections
Materials: Aluminum, brass, ductile iron, hardened stainless steel



THROTTLING VALVE OPTION

23520

1/2", 3/4" male inlet and female outlet conn.
Throttling valve
Material: Polypropylene



MATERIAL OPTIONS

Material	Code
Aluminum	AL
Brass	No code
Hardened stainless steel	HSS
Nylon/Aluminum	NY
Polypropylene	PP

SPECIFICATIONS

Inlet/Outlet Pipe Conn. (in.)	Operating Pressure Max. (bar)	Valve Type						
		23520	23120	8460	6815	6815-HSS	6815-AL	110
1/4	Up to 20							•
	20 to 48							•
	48 to 70							•
3/8	Up to 20							•
	20 to 48							•
	48 to 70							•
1/2	3.5				•		•	
	Up to 10.4	•	•					
	Up to 20			•	•		•	
	20 to 48				•		•	
	48 to 85				•	•		
3/4	Up to 3.5				•		•	
	Up to 10.4	•	•					
	Up to 20			•	•		•	
	20 to 48				•		•	
	48 to 85				•	•		

ORDERING INFORMATION

PRESSURE RELIEF/REGULATING VALVE



BSPT connections require the addition of a "B" prior to the inlet connection. Pressure rating is ordered in psi.

THROTTLING VALVE

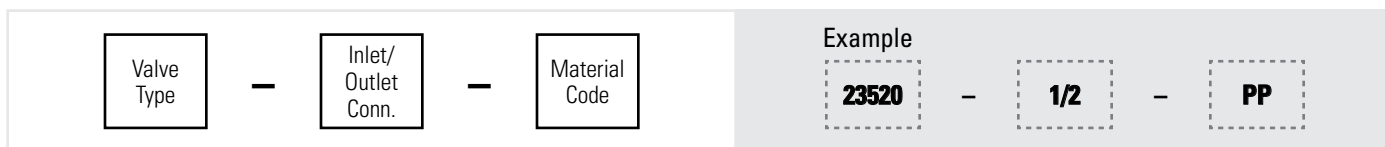

BSPT connections require the addition of a "B" prior to the inlet connection.

THROTTLING AND PRESSURE RELIEF/REGULATING VALVES

ACCESSORIES

DIMENSIONS AND WEIGHTS

Valve	Accessory Type	Inlet/Outlet Conn. (in.)	L at Max. Opening Height (mm)	A (mm)	B (mm)	W (mm)	Net Weight (kg)
	23520	1/2	102	–	29.8	51	0.08
		3/4	114	–	35.8	57	0.08
	23120	1/2	133	26	60.3	66.8	0.16
		3/4	133.4	26	60.3	68.3	0.16
	9840	1/2	220.7	38.1	74.7	81.3	0.06
		3/4	220.7	38.1	74.7	81.3	0.06
	8460	1/2	203.2	30.9	41.2	71.4	0.42
		3/4	203.2	30.9	41.2	71.4	0.37
	6815	1/2	168.3	48.4	69.9	63.5	0.59
		3/4	168.3	48.4	69.9	63.5	0.59
	110	1/4	101.6	–	30.9	42.9	0.2
		3/8	101.6	–	30.9	42.9	0.2
		1	184.1	–	63.9	68.3	1.23
		1-1/4	184.1	–	66.3	69.9	1.41
		1-1/2	196.9	–	106.9	25.4	1.54

Based on the largest/heaviest version of each type.

**SPRAYING SYSTEMS CO.'S
TRADEMARK USAGE**

The following is a current list of Spraying Systems Co.'s trademarks registered in the United States. Some marks are registered in other countries as well.

Clip-Eyelet®	QCIMEG™
ConeJet®	QJ®
DeflectoJet®	QuickJet®
FlatJet®	ProMax®
FloodJet®	Spraying Systems Co.®
FoamJet®	TriggerJet®
FullJet®	UniJet®
GunJet®	VeeJet®
IMEG®	WashJet®
iSpray®	WindJet®

Spraying Systems Co. reserves the right to make changes in specifications or design of the products shown in the catalog or to add improvements at anytime without notice or obligation.

HOW TO ORDER

In each product section, you'll find ordering examples. Start by reviewing the example and then create the part number by indicating the inlet connection, material and capacity size.

SPRAY GUN ASSEMBLY



For your convenience, there are multiple ways to place an order: phone, fax and online

In North America

Phone: 1.800.95.SPRAY | Fax: 1.888.95.SPRAY

Outside North America

Phone: 1.630.665.5000 | Fax: 1.630.260.0842

Online ordering with a credit card is also available. Visit spray.com/ispray. You'll find helpful selection tools and a Live Chat option for immediate assistance.

FINDING PRODUCTS

- Consult the Product Index on **page i-3** if you know the name of the product
- Consult the Part Number Index on **page i-4** if you have the part number. Part numbers are shown numerically and alpha-numerically

Selection assistance is also available by calling **1.800.95.SPRAY**. Representatives in your local sales office will help you determine which products best meet your application requirements. (Call **1.630.665.5000** outside North America or visit spray.com to find information for the sales office in your area.)

**REGISTERED TRADEMARK
CREDITS**

The following trademarks are registered to other entities in the US and may be registered in other countries as well.

Celcon®	Celanese Corporation
DELTRIN®	E.I. du Pont de Nemours and Company
Fairprene®	E.I. du Pont de Nemours and Company
Kynar®	Arkema, Inc.
Viton®	DuPont Performance Elastomers



(1) MODIFICATION OF TERMS

Seller's acceptance of any order is expressly subject to Buyer's assent to each and all of the terms and conditions set forth below and Buyer's assent to these terms and conditions shall be conclusively presumed from Buyer's receipt of this document without prompt written objection thereto or from Buyer's acceptance of all or any part of goods ordered. No addition to or modification of said terms and conditions shall be binding upon Seller unless specifically agreed to by Seller in writing. If Buyer's purchase order or other correspondence contains terms or conditions contrary to or in addition to the terms and conditions set forth below, acceptance of any order by Seller shall not be construed as assent to such contrary or additional terms and conditions or constitute a waiver by Seller of any of the terms and conditions.

(2) PRICE

Unless otherwise specified: (a) all prices, quotations, shipments and deliveries by Seller are (i) EXW (Incoterms® 2010) if shipped to the Buyer within the United States, and (2) in all other circumstances DAP Buyer's location (Incoterms 2010); (b) all base prices together with related extras and deductions, are subject to Seller's price in effect at the time of shipment; and (c) notwithstanding the use of the shipping term DAP and without any effect on the point at which the risk of loss shifts from Seller to Buyer, all transportation, import costs and other related charges are for the account of Buyer, including all increases or decreases in such charges prior to shipment. Payment of said price shall be due at the remittance address shown on the Seller's invoice upon receipt of Seller's invoice unless otherwise specified. Interest will be charged at a rate of 1 to 1-1/2% per month on all balances outstanding more than 30 days after the date of the invoice. Price includes Seller's standard packaging. Special packaging requirements shall be quoted at an additional price.

(3) UNIFORM COMMERCIAL CODE

THIS IS A CONTRACT FOR THE SALE OF GOODS. SELLER AND BUYER EXPRESSLY AGREE THAT ANY SERVICES PROVIDED PURSUANT TO THIS CONTRACT ARE MERELY INCIDENTAL TO THE SALE OF GOODS, AND AS SUCH, SHALL BE DEEMED GOODS UNDER ARTICLE 2 OF THE UNIFORM COMMERCIAL CODE. SELLER AND BUYER FURTHER AGREE THAT ANY DISPUTES ARISING FROM THIS CONTRACT SHALL BE GOVERNED BY ARTICLE 2 OF THE UNIFORM COMMERCIAL CODE.

(4) MINIMUM BILLING

Contact your regional office representative for any minimum order requirements.

(5) WARRANTIES

Seller warrants that its products will conform to and perform in accordance with the products' specifications. Seller warrants that the products do not infringe upon any copyright, patent, or trademark. THE FOREGOING WARRANTIES ARE IN LIEU OF ALL OTHER WARRANTIES, EXPRESSED OR IMPLIED, INCLUDING, BUT NOT LIMITED TO, THOSE CONCERNING MERCHANTABILITY AND FITNESS FOR A PARTICULAR PURPOSE.

(6) LIMITATION OF REMEDIES

Buyer's remedies under this warranty shall be limited to the replacement, repair, or refund of the purchase price for any defective product at the Seller's option. Products claimed to be defective and for which repair or replacement is desired shall be, if requested by the Seller, returned transportation prepaid to Seller's plant for inspection. Results of ordinary wear and tear, improper operation, or maintenance or use of corrosive or abrasive materials shall not be considered a defect in material or workmanship. Any component part manufactured by another is not covered by Seller's warranty, but only by such warranty as its manufacturer gives. Because of the difficulty of asserting and measuring damages hereunder, it is agreed that, except for claims for bodily injury, Seller's liability to the Buyer or any third party, for any losses or damages, whether direct or otherwise, arising out of the purchase of product from Seller by Buyer shall not exceed the total amount billed and billable to the Buyer for the product

hereunder. IN NO EVENT WILL SELLER BE LIABLE FOR ANY LOSS OF PROFITS OR OTHER SPECIAL OR CONSEQUENTIAL DAMAGES, EVEN IF SELLER HAS BEEN ADVISED OF THE POSSIBILITY OF SUCH DAMAGES.

(7) QUALITY ASSURANCE

Seller shall have no obligation to ensure that any goods purchased from Seller meet any special Buyer quality assurance specifications and/or other special Buyer requirements unless such specifications and/or other requirements are specifically set forth in Buyer's purchase order and expressly accepted by Seller. In the event that any such goods supplied by Seller in connection therewith, are applied to an end use without the appropriate specification and/or other requirement therefore having been set forth in Buyer's purchase order and expressly accepted by Seller, Buyer shall indemnify and hold Seller harmless against any and all damages or claims for damages made by any person for any injury, fatal or nonfatal, to any person or for any damage to the property of any person incident to or arising out of such application.

(8) PRODUCT DISPOSAL & SUSTAINABILITY

Buyer is responsible for the disposal of goods supplied by seller in accordance with all applicable laws, regulations, and responsible recycling and/or sustainability practices.

(9) CLAIMS

Claims respecting the condition of goods, compliance with specifications or any other matter affecting goods shipped to Buyer must be made promptly and, unless otherwise agreed to in writing by Seller, in no event later than one (1) year after receipt of the goods buy Buyer. In no event shall any goods be returned, reworked or scrapped by Buyer without the express written authorization of Seller.

(10) DEFAULT IN PAYMENT

If Buyer fails to make payments on any contract between Buyer and Seller in accordance with Seller's terms, Seller, in addition to any other remedies available to it, may at its option, (i) defer further shipments until such payments are made and satisfactory credit arrangements are reestablished or (ii) cancel the unshipped balance of any order.

(11) TECHNICAL ASSISTANCE

Unless otherwise expressly stated by Seller, (a) any technical advice provided by Seller with respect to the use of goods furnished to Buyer shall be without charge; (b) Buyer shall have sole responsibility for selection and specification of the goods appropriate for the end use of such goods.

(12) SAFETY PRECAUTIONS

Buyer shall require its employees to use all safety devices, and proper safe operation procedures as set forth in manuals and instruction sheets furnished by Seller. Buyer shall not remove or modify any such device or warning sign. It is the Buyer's responsibility to provide all means that may be necessary to effectively protect all employees from serious bodily injury which otherwise may result from the method of particular use, operation, set up or service of the goods. The operator's or machine manual, ANSI safety standards, OSHA regulations and other sources should be consulted. If Buyer fails to comply with provisions of this paragraph or the applicable standards and regulations aforementioned, and a person is injured as a result thereof, Buyer agrees to indemnify and save Seller harmless from any liability or obligation incurred by Seller.

(13) CANCELLATION

Orders for goods specifically manufactured for Buyer cannot be canceled or modified by Buyer, and releases cannot be held up by Buyer, after such goods are in process except with the express written consent of Seller and subject to conditions then to be agreed upon which shall include, without limitation, protection of Seller against all loss.

(14) PATENTS

The Seller shall not be liable for any costs or damages incurred by the Buyer as a result of any suit or proceeding brought against Buyer so far as based on claims (a) that use of any product, or any part thereof furnished hereunder, in combination with products not supplied by the Seller or (b) that a manufacturing or other process utilizing any product, or any part thereof furnished hereunder, constitute knowing and willful infringement of patents or trademarks arising from compliance with Buyer's designs or specifications or instructions.

(15) COMPLETE AGREEMENT

THIS CONTRACT SETS FORTH THE ENTIRE AGREEMENT AND UNDERSTANDING OF THE PARTIES RELATING TO THE SUBJECT MATTER HEREOF, AND SUPERSEDES ALL PRIOR AGREEMENTS, DISCUSSIONS AND UNDERSTANDINGS BETWEEN THEM WHETHER ORAL OR WRITTEN, RELATING TO THE SUBJECT MATTER HEREOF.

(16) GOVERNING LAW

All orders are accepted by Seller at its mailing address in Wheaton, Illinois, and shall be governed by and interpreted in accordance with the laws of the State of Illinois. The United Nations Convention on Contracts for the International Sale of Goods of April 11, 1980 shall be excluded.

(17) FORCE MAJEURE

Neither party shall be in default of its obligations to the other party for any period of Force Majeure. "Force Majeure" shall mean any delay or failure of a party to perform its obligations to the other party due to causes beyond its control and without its fault or negligence. This shall include, without limitation, Acts of God, strike, civil commotion, acts of government, and any other comparable, non-foreseeable, and a serious event.

(18) CONFIDENTIAL INFORMATION

Buyer shall maintain Confidential Information in confidence using the same care as used for its own Confidential Information. Buyer shall not disclose or divulge any Confidential Information received by it from Seller in connection with any products or services supplied by Seller to Buyer or to a third party without prior written consent of Seller, and Buyer may not use any Confidential Information for any purpose other than for the manufacture, sale and maintenance of Buyer's products. For the purposes hereof, "Confidential Information" includes any and all information and data, including, but not limited to, any business, commercial, intellectual property, technical information and data disclosed by Seller to Buyer in connection with the sale of Seller's products to Buyer, or relating to Seller's business relationship or the definition, development, marketing, selling, manufacture or distribution of Seller's products, whether disclosed orally, in writing or electronically, and irrespective of the medium in which such information or data is embedded, whether in tangible form or contained in an intangible storage medium. Confidential Information shall include any copies or abstracts made thereof, as well as any product, apparatus, modules, samples, prototypes or parts thereof.

(19) FAIR PRACTICES

Spraying Systems Co. considers for employment and hire qualified candidates without regard to race, religion, color, sex, sexual orientation, gender, gender identity, age, national origin, ancestry, citizenship, protected veteran or disability status or any factor prohibited by law, and as such affirms in policy and practice to support and promote the concept of equal employment opportunity and affirmative action, in accordance with all applicable federal, state, provincial and municipal laws.

PRODUCT

BALL FITTINGS

36275.....E3
37235.....E3

CHECK VALVES

12328.....E4
21950.....B30
AACV.....E4
ABCV.....E4
BACV.....E4
BBCV.....E4

FLATJET® NOZZLES

P.....B20 - B21

FLOODJET® NOZZLES

K.....B22 - B23

FOAMJET® NOZZLES

7421.....B27 - B28
25775.....B27 - B28
8355-NY-BL.....B27 - B28
8360-1/4-NY-BL.....B27 - B28
8360-NY-BL.....B27 - B28
FJ.....B26, B28
FJP-PP.....B26, B28
FJP-VS.....B26, B28
QJ1/4T-NYB.....B27 - B28
QJ1/4TT-NYB.....B27 - B28
QJ17560A-NY-BL.....B27 - B28
QJ22187-NYB.....B27 - B28
QJ7421-NYB.....B27 - B28
QJ8355-NY-BL.....B27 - B28
QJ8360-NY-BL.....B27 - B28
QJFJP.....B26, B28
T.....B24 - B25, B27
TT.....B24 - B25, B27

FULLJET® NOZZLES

GG.....B2 - B3
GG-W.....B2 - B3
HH.....B2 - B3
HH-W.....B2 - B3

GUNJET® SPRAY GUNS

AA30A.....C3 - C4
AA30L.....C3 - C4
AA30L-PP.....C3 - C4
AA60.....C2, C4
AA70.....C2, C4
PW4000A.....C2, C4
PW4000AS.....C2, C4

JET STABILIZERS

11370.....B30
11950.....B30

GUNJET SPRAY EXTENSIONS

6671.....C9
7715.....C8
9527.....C8
12086.....C8
15699.....C8
20400-1/4M.....C8
20400-1/4F.....C8
22665.....C9
9004-SS.....C8

GUNJET SWIVEL CONNECTORS & ADAPTERS

4676.....C11 - C12
9765.....C10, C12
11990.....C10, C12
13212.....C11 - C12
14269.....C11 - C12
14643.....C11 - C12
15950.....C10, C12
21550.....C10, C12
36560.....C10, C12
21550-90NP.....C10, C12
8510 Strainer.....C10 - C12

PRESSURE RELIEF VALVES

110.....E5 - E7
6815.....E5 - E7
8460.....E5 - E7
9840.....E5 - E7
23120.....E5 - E7

SIPHON INJECTORS

13340.....E2
50580.....E2

THROTTLING RELIEF VALVES

23520.....E5 - E7

RETAINERS

114443-4-CELR.....B29
114445-4-CELR.....B29
CP1325.....B29
CP8027-NYB.....B29
CP18032A-NYB.....B29

TRIGGERJET® SPRAY GUNS

4688.....C5, C7
6104.....C5, C7
6590.....C5, C7
22650-PP.....C6 - C7
22670-PP.....C6 - C7
50800-15-PP-1/4.....C6 - C7
50800-PP-1/4.....C5, C7
AA31.....C6 - C7
AA36.....C6 - C7

UNIJET® STRAINERS

4067.....B31 - B32
4514.....B31 - B32
5053.....B31 - B32
6051.....B31 - B32
7630.....B31 - B32
8079.....B31 - B32
4193A.....B31 - B32

UNIJET NOZZLE

TPU.....B24 - B25

VEEJET® NOZZLES

H-DT.....B13 - B16
H-DU.....B13 - B16
H-U.....B13 - B16
H-U-CKY Blue.....B16 - B17
H-U-CKY Green.....B16 - B17
H-U-CKY Light Green.....B16 - B17
H-U-CKY Purple.....B16 - B17
H-U-CKY White.....B16 - B17
H-VV.....B13 - B16
H-VV-CKY Blue.....B18 - B19
H-VV-CKY Green.....B18 - B19
H-VV-CKY Grey.....B18 - B19
H-VV-CKY Light Blue.....B18 - B19
H-VV-CKY Light Green.....B18 - B19
H-VV-CKY Light Purple.....B18 - B19
H-VV-CKY Purple.....B18 - B19
H-VV-CKY White.....B18 - B19
H-VVL.....B13 - B16

WASHJET® NOZZLES

CERMEG.....B8 - B9
IMEG.....B4 - B7
MEG.....B4 - B7
WEG.....B4 - B7

WASHJET QUICK CONNECT NOZZLES

QCIMEG.....B10 - B12
QCMEG.....B10 - B12

WINDJET® AIR NOZZLES

AA707.....D2 - D4
AA727.....D2 - D4



NUMERIC AND ALPHABETICAL

1
 110..... E5 - E7
 11370..... B30
 11950..... B30
 11990..... C10, C12
 12086..... C8
 12328..... E4
 13212..... C11 - C12
 13340..... E2
 14269..... C11 - C12
 14643..... C11 - C12
 15699..... C8
 15950..... C10, C12
 114443-4-CELR..... B29
 114445-4-CELR..... B29

2
 20400..... C8
 20400..... C8
 21550..... C10, C12
 21550-90NP..... C10, C12
 21950..... B30
 22650-PP..... C6 - C7
 22665..... C9
 22670-PP..... C6 - C7
 23120..... E5 - E7
 23520..... E5 - E7
 25775..... B27 - B28

3
 36275..... E3
 36560..... C10, C12
 37235..... E3

4
 4067..... B31 - B32
 4193A..... B31 - B32
 4514..... B31 - B32
 4676..... C11 - C12
 4688..... C5, C7

5
 5053..... B31 - B32
 50580..... E2
 50800-15-PP-1/4..... C6 - C7
 50800-PP-1/4..... C5, C7

6
 6051..... B27 - B28
 6104..... C5, C7
 6590..... C5, C7
 6671..... C9
 6815..... E5 - E7

7
 7421..... B27 - B28
 7630..... B31 - B32
 7715..... C8

8
 8079..... B31 - B32
 8460..... E5 - E7
 8355-NY-BL..... B27 - B28
 8360-1/4-NY-BL..... B27 - B28
 8360-NY-BL..... B27 - B28
 8510 Strainer..... C10 - C12

9
 9004-SS..... C8
 9527..... C8
 9765..... C10, C12
 9840..... E5 - E7

A
 AA30A..... C3 - C4
 AA30L..... C3 - C4
 AA30L-PP..... C3 - C4
 AA31..... C6 - C7
 AA36..... C6 - C7
 AA60..... C2, C4
 AA70..... C2, C4
 AA707..... D2 - D4
 AA727..... D2 - D4
 AACV..... E4
 ABCV..... E4

B
 BACV..... E4
 BBCV..... E4

C
 CERMEG..... B8 - B9
 CP1325..... B29
 CP8027-NYB..... B29
 CP18032A-NYB..... B29

F
 FJ..... B26, B28
 FJP-PP..... B26, B28
 FJP-VS..... B26, B28

G
 GG..... B2 - B3
 GG-W..... B2 - B3

H
 H-DT..... B13 - B16
 H-DU..... B13 - B16
 HH..... B2 - B3
 HH-W..... B2 - B3
 H-U..... B13 - B16
 H-U-CKY Blue..... B16 - B17
 H-U-CKY Green..... B16 - B17
 H-U-CKY Light Green..... B16 - B17
 H-U-CKY Purple..... B16 - B17
 H-U-CKY White..... B16 - B17
 H-VV..... B13 - B16

H-VV-CKY Blue..... B18 - B19
 H-VV-CKY Green..... B18 - B19
 H-VV-CKY Grey..... B18 - B19
 H-VV-CKY Light Blue..... B18 - B19
 H-VV-CKY Light Green..... B18 - B19
 H-VV-CKY Light Purple..... B18 - B19
 H-VV-CKY Purple..... B18 - B19
 H-VV-CKY White..... B18 - B19
 H-VVL..... B13 - B16

I
 IMEG..... B4 - B7

K
 K..... B22 - B23

M
 MEG..... B4 - B7

P
 P..... B20 - B21
 PW4000A..... C2, C4
 PW4000AS..... C2, C4

Q
 QCIMEG..... B10 - B12
 QCMEG..... B10 - B12
 QJ1/4T-NYB..... B27 - B28
 QJ1/4TT-NYB..... B27 - B28
 QJ17560A-NY-BL..... B27 - B28
 QJ22187-NYB..... B27 - B28
 QJ7421-NYB..... B27 - B28
 QJ8355-NY-BL..... B27 - B28
 QJ8360-NY-BL..... B27 - B28
 QJFJP..... B26, B28

T
 T..... B24 - B25, B27
 TPU..... B24 - B25
 TT..... B24 - B25, B27

W
 WEG..... B4 - B7

