



**Spraying Systems Co.®**  
Experts in Spray Technology

# PULP & PAPER MILL SPRAY TECHNOLOGY



PAPER CATALOG+  
PERFORMANCE DATA

[spray.com](http://spray.com)



# COMPREHENSIVE SPRAY TECHNOLOGY SOLUTIONS FROM A SINGLE SOURCE

WE LOOK FORWARD TO HELPING YOU OPTIMIZE YOUR OPERATIONS INVOLVING SPRAY TECHNOLOGY.

Many of our showers and nozzles are specially designed for use in pulp, paper and tissue mills. Our products are optimized for transfer efficiency, impact, precision, water conservation, quick maintenance and more. We have the most comprehensive line of spray products available — and are always willing to make nozzles in different materials and sizes to ensure you get the performance you need. In addition to standard showers, our built-to-order showers are customized to your requirements.













- Use this catalog to research nozzles, shower options, chest cleaners and more. You'll also find additional catalogs on these product lines on [spray.com](http://spray.com):
  - Industrial hydraulic spray products
  - TankJet® tank cleaning products
  - Automatic & air atomizing spray nozzles
  - GunJet® spray guns
  - WindJet® air products
- Tap into local spray expertise: your local spray expert is always nearby and willing to help. Even when operations seem to be working properly, there may be ways to further reduce waste and maximize uptime. Your local expert can conduct an on-site, no-cost optimization evaluation, demonstrate products, conduct proof-of-concept tests and assist with payback calculations.
- Advance your sustainability goals. Your local expert can offer solutions that reduce waste and use water and energy more efficiently.
- Implement the best possible solution. By simulating your operating conditions in our spray laboratories or using Computational Fluid Dynamics (CFD) modeling, we can determine which shower designs and nozzles will be most effective. See page A5.

For nearly 80 years, our sole focus has been on spray technology. We provide engineering and technical support to mills around the world from our ten manufacturing facilities and more than 90 sales offices.

**Just give us a call at 1.800.95.SPRAY or visit [spray.com](http://spray.com) to learn more.**



## TABLE OF CONTENTS

Pulp, Paper and Tissue Production	2 ▶	
Fabrication and Testing	A1 ▶	
Showers	B1 ▶	
Shower Nozzles	C1 ▶	
Web-Trimming Nozzles	D1 ▶	
Flat Spray Nozzles	E1 ▶	
Hollow Cone Nozzles	F1 ▶	
Automatic and Air Atomizing Nozzles	G1 ▶	
Chest Cleaners	H1 ▶	
Air Knife Packages and Air Nozzles	I1 ▶	
Spray Guns	J1 ▶	
Optimization Tips	K1 ▶	
Index	i-1 ▶	



# SOLUTIONS FOR MAKING PULP, PAPER & TISSUE

## WOOD PREPARATION & PULPING

### PULPING

- Testing and modeling using Computational Fluid Dynamics (CFD)
- VeeJet® flat spray nozzles
- WhirlJet® CF, CX and CRC hollow cone nozzles
- Black liquor nozzles

### BLEACHING

- NeedleJet shower nozzles, 19124
- Built-to-order brushless, brush-type and oscillating showers
- TankJet® tank cleaning equipment
- VeeJet and NeedleJet nozzles in corrosion-resistant materials

### WOOD PREPARATION

- WhirlJet AX and BX hollow cone nozzles
- VeeJet and UniJet® flat spray nozzles
- Air atomizing nozzles

### STOCK PREPARATION

- TankJet tank cleaning equipment
- Self-cleaning shower nozzles
- FlatJet® flat spray nozzles
- Rotoclean® FlatJet flat spray nozzles, 115220

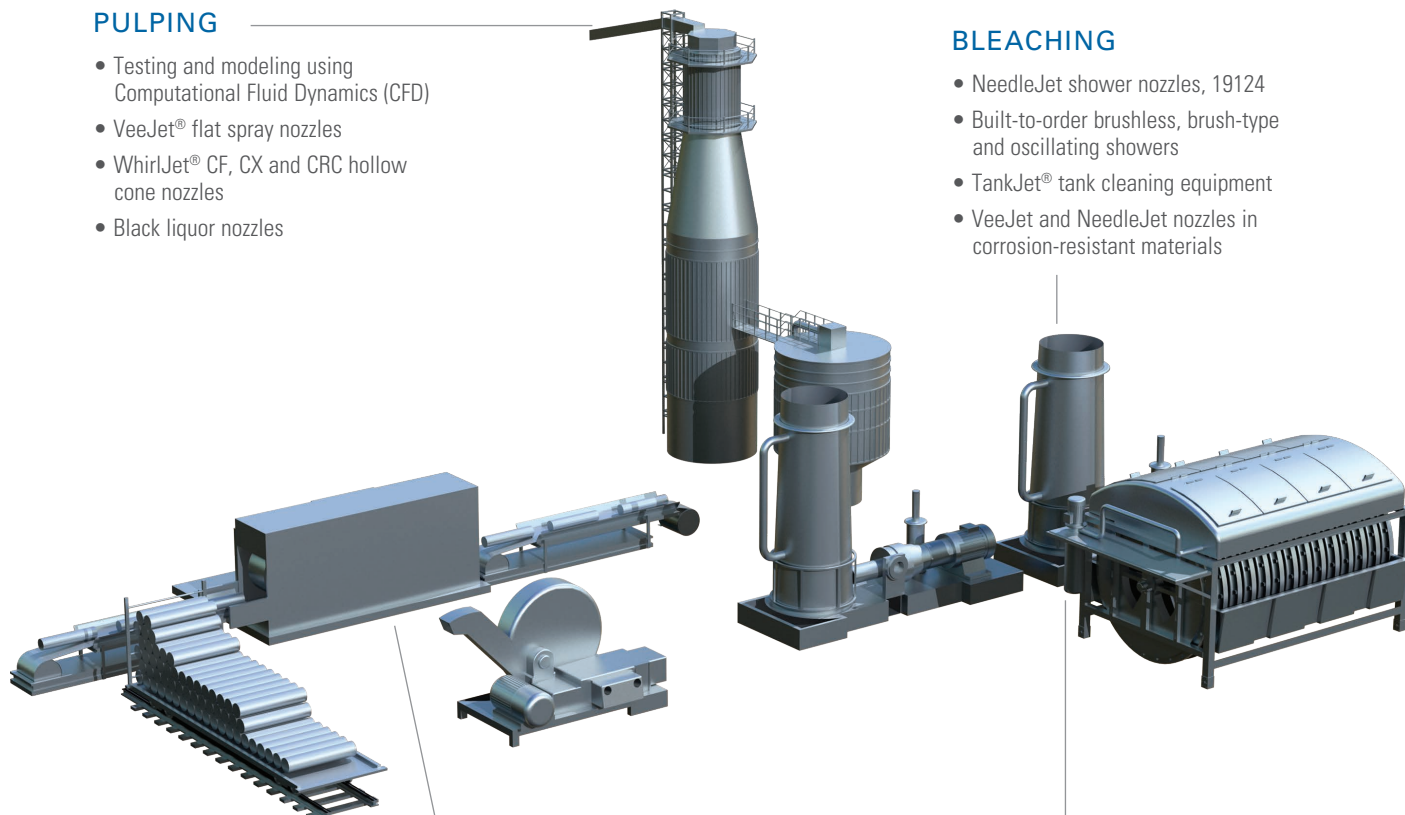

## PAPER & TISSUE PRODUCTION

### TISSUE MAKING, DRY END

- Quick VeeJet® flat spray nozzles, QVVA and 58106
- Quick UniJet® flat spray nozzles
- Pipe-in-pipe showers
- Trimming nozzles for tail cutting

### WET END

- ShowerJet nozzles
- NeedleJet nozzles
- FloodJet® flat spray nozzles
- FlatJet® flat spray nozzles
- VeeJet flat spray nozzles
- Trimming nozzles and alignment devices
- Built-to-order brushless, brush-type, pipe-in-pipe and oscillating showers
- T-style strainers

### THE PAPER MACHINE, DRY END – SIZE, PRESS AND COATING

- Built-to-order air atomizing nozzles and showers
- Box-style moisturizing showers
- PulsaJet® precision coating showers
- WindJet® air nozzles

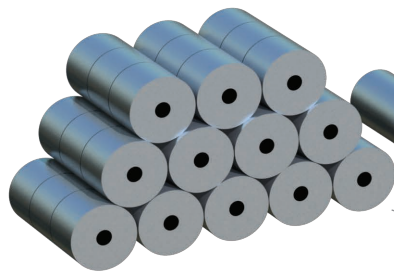
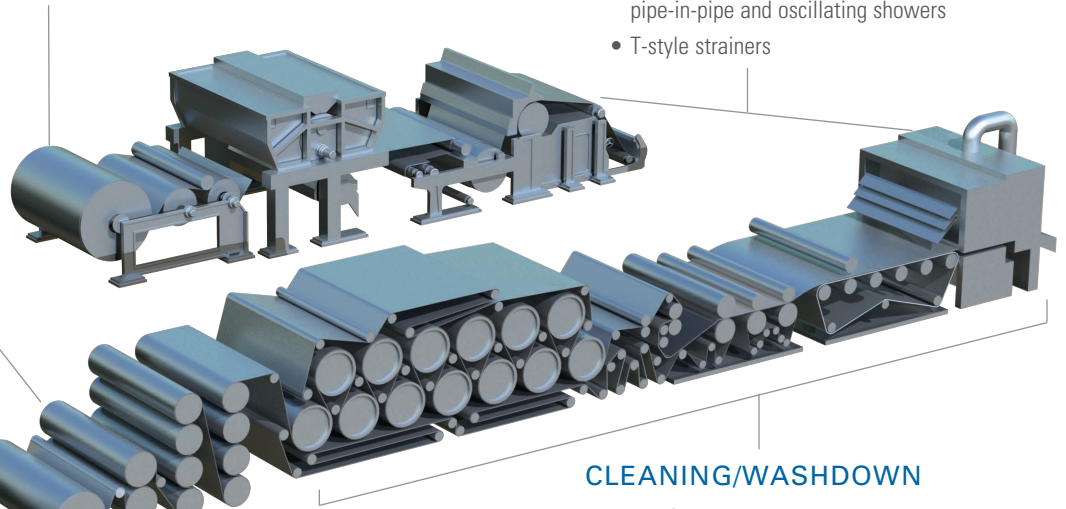

### STORAGE

- YMF MiniFogger® III
- 45400 Humidification Unit
- DripSafe™ AirJet® Fogger nozzle
- 1/8JJ air atomizing nozzles

### CLEANING/WASHDOWN

- GunJet® handheld spray guns
- TankJet® chest cleaners, 6353 and 27500
- WindJet air nozzles and air knife packages
- VeeJet spray nozzles

## CONVERTING

### CONVERTING

- PulsaJet precision coating showers
- Built-to-order air atomizing showers
- AutoJet® 1550+ modular spray system
- WindJet air nozzles
- Self-cleaning web lamination showers

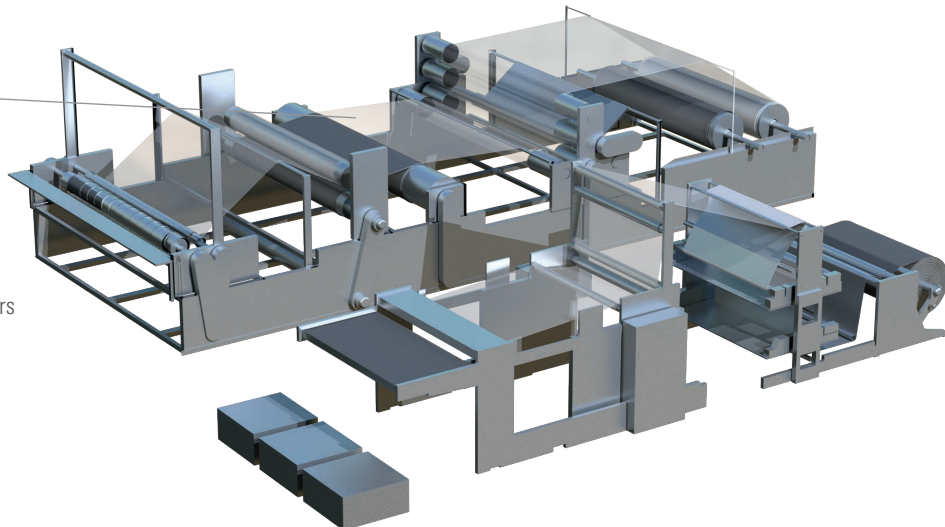



## UNIQUE FABRICATION, MODELING AND TESTING SERVICES HELP ENSURE OPTIMAL PROCESS QUALITY

The most critical components in any spray system are the spray nozzles. Choosing the nozzles that will deliver the precise performance required for your operation is essential to quality. Flow rate, coverage, transfer efficiency, precision and other spray characteristics can be the difference between defect-free paper and tissue and high waste and scrap.

Once the nozzles are selected, it is just as important to ensure the equipment feeding the nozzles is optimized. Inadequate or excessive pressure and flow in showers can result in paper breaks and quality problems.

## BUILT-TO-ORDER SHOWERS

### OVERVIEW

Tell us what you need. Chances are we've built it before. We design and build showers for a wide range of operations. From brushless or brush-type to air atomizing and oscillating, our extensive capabilities allow us to build exactly to your specifications and needs.

#### Some commonly used shower designs are:

- Brushless and brush-type lubricating and chemical showers
- Brushless and brush-type pipe-in-pipe showers
- Enclosed air atomizing moisturizing showers

Connections, header length, nozzle spacing and more can be customized to fit your requirements and minimize the need for physical rework of equipment. Showers can be equipped with a wide range of conventional or quick-connect nozzles, special nozzle orientations, multiple nozzle rows or spray zones, air barriers or blow-off curtains and more.

#### Some examples of configurations include:

- Dual rows of nozzles to reduce the number of showers needed
- Customer-specified mounting to fit existing equipment
- Inner pipe inlet position based on existing liquid feed lines

Let us help you optimize shower performance with showers and headers that will retrofit easily into your current operations.

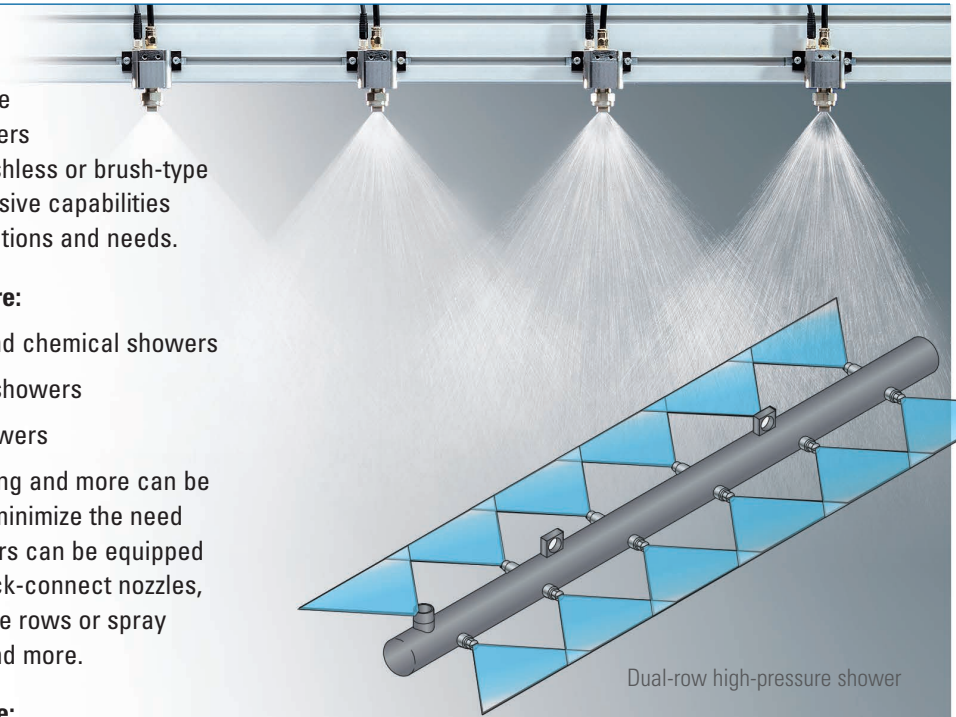

Dual-row high-pressure shower

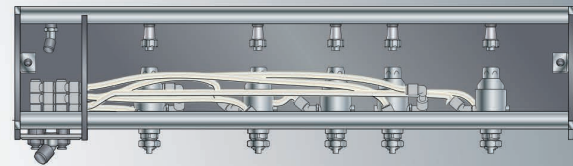

Two-zone manifold with air atomizing nozzles

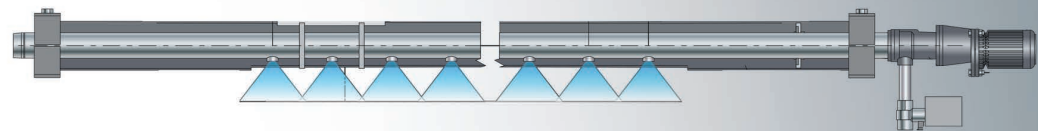

ShowerJet automatic brush shower

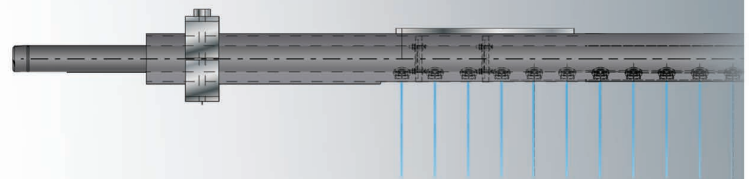

Oscillating NeedleJet shower with integrated solvent shower

Ask your local spray expert for more information on our fabrication and testing services.

## SPRAY CHARACTERIZATION

### OVERVIEW

In operations where spray performance is critical, it is important to understand how factors like these affect performance:

- Process conditions such as pressure, temperature and variable line speeds
- The liquid being sprayed
- The placement and position of nozzles in relation to the target

#### For example:

In many cases, experience and theoretical calculations can provide an indication of actual spray performance. However, testing in our spray labs determines actual performance and can eliminate costly specification mistakes or quality problems after installation.

In our state-of-the-art spray laboratories, we can adjust and/or test different nozzles and shower configurations to find the exact performance required for your operation.

#### Common tests include:

- Spray characterization
- Spray angle
- Drop size distribution
- Evaporation rate
- Spray impact
- Residence time
- Spray pattern
- Dwell time
- Spray coverage

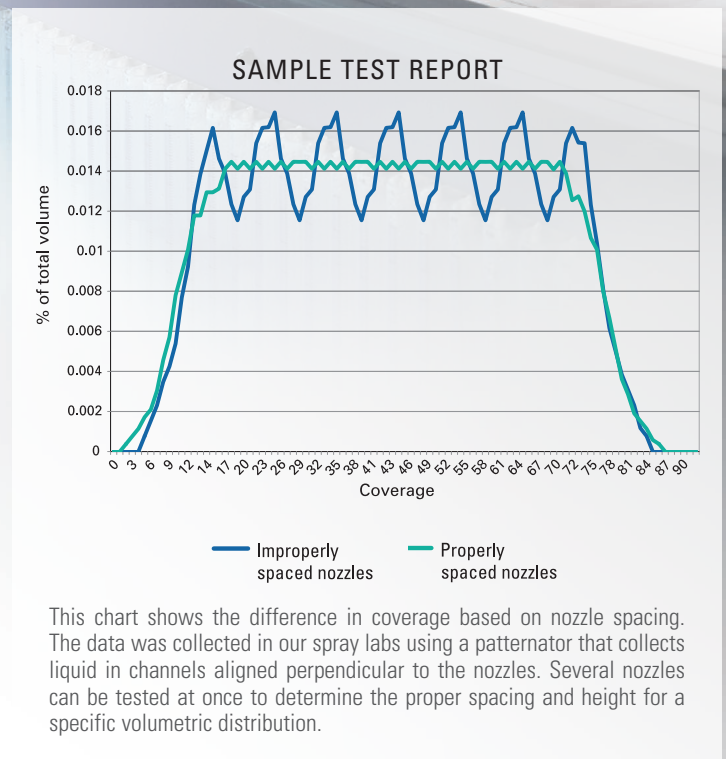

Ask your local spray expert for more information on our fabrication and testing services.



## WEAR TESTING

### OVERVIEW

Like any precision component, nozzles will wear over time. This wear is not always visible – especially in the early stages. However, even slight wear (10 to 15%) can cost thousands of dollars per month in wasted water, energy and disposal costs. In addition, you may experience quality problems since wear increases the amount of liquid being applied.

Shower nozzles that are even slightly worn will spray over capacity and waste precious water, chemicals and electricity.

We offer a free nozzle wear testing program for our customers.

#### Program details:

- Ship nozzles from various points on a single shower to us after they've been in use for several months
- Tests will be conducted in our spray labs to determine the wear rate
- Your nozzles will be returned to you along with recommendations for optimal replacement intervals

### HERE ARE TWO EXAMPLES THAT ILLUSTRATE THE EXPENSE ASSOCIATED WITH USING WORN NOZZLES.

#### EXAMPLE #1: DRYER SECTION SHOWER

One shower with 70 nozzles spraying a release agent on dryer felt

**The cost to operate this one shower increases from \$54,803 to \$63,073. If you have six showers in the dry end, your costs increase by \$49,620 annually.**

#### OPERATING CONDITIONS:

- System sprays 5 gpm (19 lpm) of a 1:20 aqueous solution of chemical at 40 psi (2.76 bar)
- Chemical consumption: .25 gpm (.95 lpm); \$0.50 per gallon
- Operation: Three shifts, five days per week = 120 hours per week

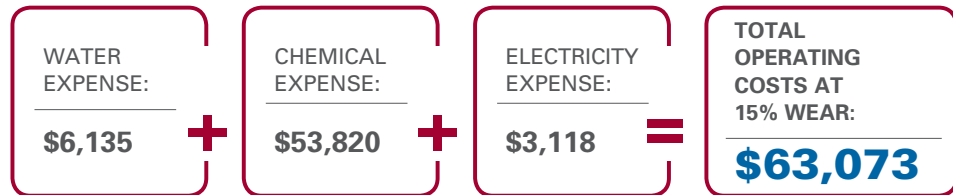

Note: Does not include water filtration and recovery costs. All costs are in USD.

#### EXAMPLE #2: FABRIC CLEANING SHOWER

Five showers – each with 72 high-pressure nozzles

**The increased capacity for just one shower increases water consumption costs by over \$13,000 annually. Multiply that by five showers and water costs quickly escalate to over \$65,000 a year.**

#### OPERATING CONDITIONS:

- Nozzle size: 2.34 gpm (8.8 lpm) at 350 psi (24.1 bar)
- Operation: 60 hours per week, 48 weeks per year

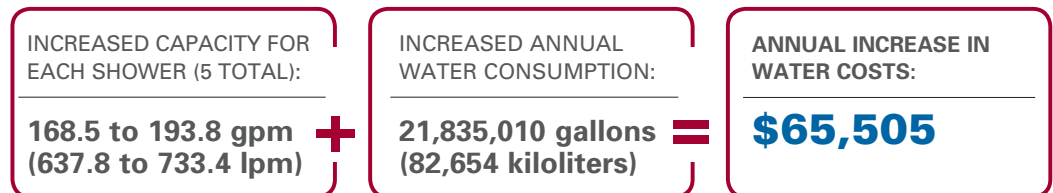

Note: Assumes water cost of \$3.00 per 1000 gallons. All costs are in USD.

Use our online Nozzle Wear Calculator to help expedite your calculation: [www.spray.com](http://www.spray.com)

Ask your local spray expert for complete details on our complimentary nozzle wear testing program.



## COMPUTATIONAL FLUID DYNAMICS (CFD) MODELING

### OVERVIEW

When exact operating conditions cannot be replicated in our labs, we use CFD modeling to help achieve an optimized spray solution. Simulation provides more information about the key factors that impact the success of an application. Our models use known inputs collected in our spray labs. This proprietary data improves model accuracy and illustrates flow patterns, velocity, turbulence, droplet trajectories, internal system pressure and more.

#### Typical uses for CFD modeling include:

- Determination of optimal shower design and nozzle placement
- Transfer efficiency in high-speed web lines
- Turbulence analysis
- Internal flow characteristics of spray nozzles under specific operating conditions
- Gas cooling/conditioning analysis to determine lance and nozzle placement in ducts, scrubbers, furnaces, cooling towers and more











Ask your local spray expert for more information on our fabrication and testing services.



# SHOWERS

## TABLE OF CONTENTS

	PAGE
 Automatic Brush	B2
 PulsaJet® Manifold	B2
 AutoJet® Self-Cleaning Web Lamination	B3
 AutoJet Oscillator Shower Assembly	B3
 Air Atomizing	B4
 Pipe-in-Pipe Air Atomizing	B4
 Brushless	B5
 Spray Control Options	B5



**OVERVIEW: SHOWERS**

**Ideal for: cleaning, coating, moisturizing and more**

- Easily retrofit from manually operated showers to affordable automated versions
- Find solutions for reducing nozzle plugging and easier maintenance
- A spray controller can be added to any of our showers to optimize spray nozzle performance, lower operating costs and automate operation

**MORE SOLUTIONS:**

We manufacture an extensive line of showers. If you don't see exactly what you need, be sure to contact us. We custom design showers and modify existing designs for customers daily.

**SHOWER OPTIONS**

**Automatic Brush Shower**

- Affordable, automated solution eliminates the manual rotation of handwheels for improved worker safety
- An internal rotating brush assembly scrubs the interior wall of the shower as well as each disc-type shower nozzle orifice to prevent clogging and help ensure long nozzle wear life – ideal for all brush-type showers up to 3" in diameter
- Easy operation. Cleaning cycles occur automatically when used with the programmable timer. If not, activation requires a simple push of a button
- In just a few seconds, debris is swept away through the flush-out valve, restoring full liquid flow to the system without contaminating the sprayed surface
- Virtually maintenance free, aside from gear lubrication twice a year
- Straightforward and easy retrofit solution – a field brush header can be retrofitted from a manual wheel to automatic operation in as little as seven minutes

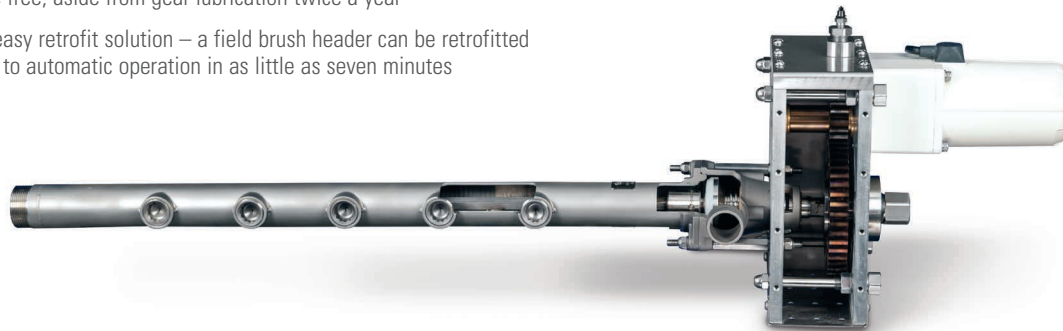

**PulsaJet® Manifold**

- Eliminate overspray and waste of costly chemicals
- Achieve precision spray control (PSC) when used with a wide range of AutoJet® control panels or modular PSC systems
- PSC involves switching electrically-actuated hydraulic or air atomizing nozzles on and off repeatedly at a controlled rate; pressure remains constant, enabling flow rate changes without changes in spray performance, and application rates remain consistent even when operating conditions, like line speed, change
- Increase your process control by also adding nozzle zoning across the web; change total spray coverage or alter application rate to any zone

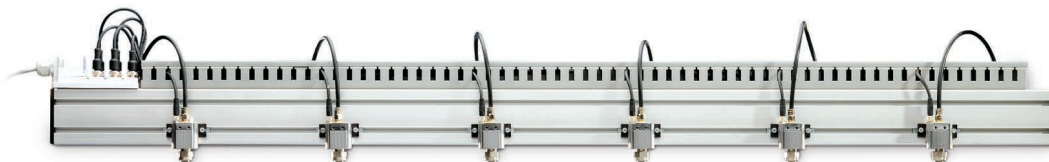

SHOWER OPTIONS

**AutoJet Self-Cleaning Web Lamination Shower**

- Minimize waste and scrap. Precise application of foamed adhesives on tissue creates excellent bonding without affecting the drape or softness of the material
- Extends production runs and reduces maintenance downtime – automatically cleans the inside of the header, nozzles, and air lines in place
- More efficient operation means lower operating costs compared to hot-melt and water-based spray systems
- **View the AutoJet® Self-Cleaning Headers video on [spray.com/YouTube](http://spray.com/YouTube)**

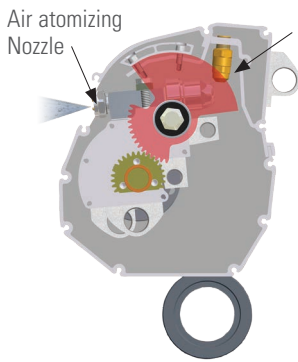

**During Normal Operation**

Air atomizing nozzles spray coating solution  
FullJet® full cone nozzles, not in use, are housed behind a shutter

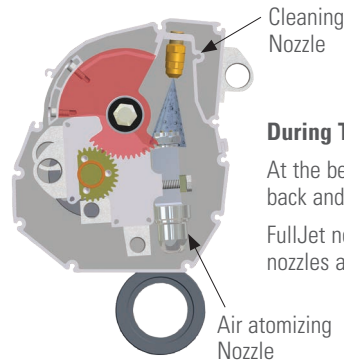

**During The Cleaning Cycle**

At the beginning of the cycle, the header rocks back and the shutter closes  
FullJet nozzles spray directly on the air atomizing nozzles and header and remove buildup

**AutoJet Oscillator Shower Assembly**

- Precise movement ensures continuous and uniform felt cleaning with minimal water usage
- Users can easily and precisely control stroke and speed; settings can be stored or adjusted on-the-fly
- Alarm messages display if the controller detects operational problems
- Operating parameters can be pre-programmed prior to delivery to further simplify set-up
- Durable construction – waterproof design withstands washdown; all wetted parts are constructed of 316 stainless steel
- Easy integration into existing lines
- Integral proximity sensors use closed-loop communication to monitor stroke position and provide system protection
- Minimal maintenance



**SHOWER SPECIFICATIONS**

Visit [spray.com/specsheets](http://spray.com/specsheets) to download specification sheets or contact your local spray expert to discuss your application needs.

SHOWER OPTIONS

**Air Atomizing Shower**

- Headers feature compressed air to spray the most difficult solutions
- Perfect for dry end moisturizing showers, specialty showers, or very low application rates
- Small header segments with consolidated connections drive multiple nozzles from each feed, no more spider webs of tubing
- Built to order for machine widths and mounting arrangements
- Optional zoning of header segments for sheet width changes
- Nozzles can be equipped with clean-out needles to minimize clogging
- Optional stainless steel enclosure protects nozzles and air and liquid lines; cover is hinged to provide easy access
- Optional mounting assembly permits rotation of the shower

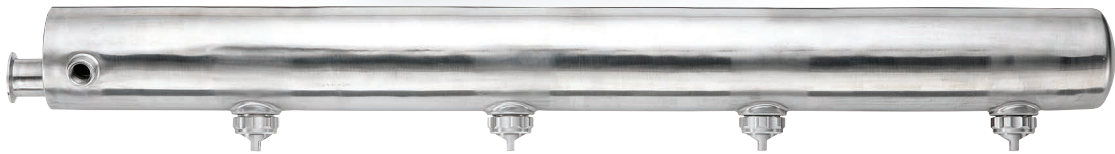
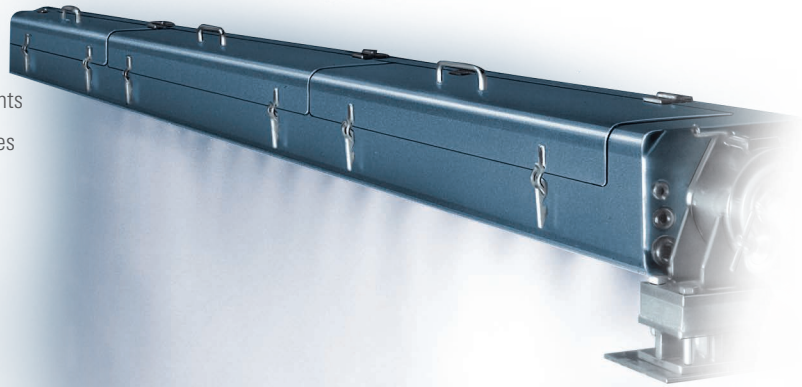

**Pipe-in-Pipe Air Atomizing Shower**

- Protects nozzles from overspray, dirt, dust and accidental damage
- Outer slotted tube encloses a conventional pipe manifold
- Economical alternative to a traditional box-style manifold
- Economical air atomizing shower for difficult-to-spray solutions
- Can also be used with brush or brushless internal showers
- Lightweight for easy installation



SHOWER OPTIONS

**Brushless Shower**

- Designed for use with fresh water and operations where nozzle clogging is unlikely
- For use with self-cleaning nozzles when brushes are not desired
- Economical

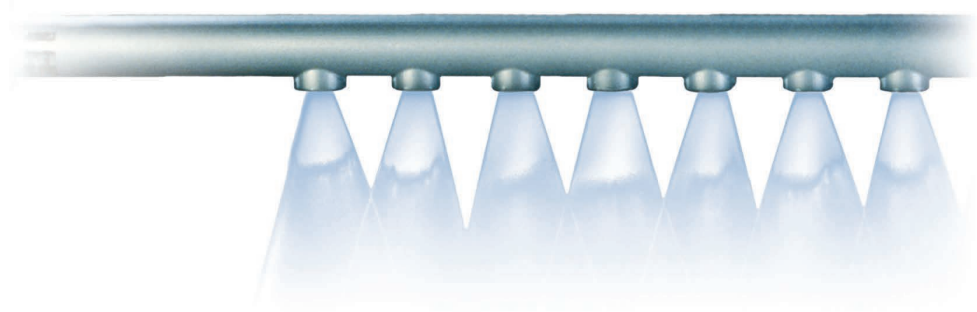

SPRAY CONTROL OPTIONS

A spray controller can be added to any of our showers to optimize spray nozzle performance, lower operating costs and automate operation. More critical operations, such as coating and moisturizing, tend to experience the greatest efficiency and performance gains resulting from precise control of our automatic spray nozzles.

Spray control benefits include:

- Line speed following
- Zone control of nozzles
- Precision application of costly coatings or chemicals to minimize waste
- Separate control of liquid, air and fan air pressure to ensure proper flow rate, spray angle and drop size
- Maximize nozzle cycle times
- Improve troubleshooting of spray performance
- Operator notification or shut-down on specified faults
- Easy integration with existing plant control systems

**For information on controllers, see Automatic and Air Atomizing Spray Nozzles, Cat. 76, section B**



Our AutoJet Spray Controllers range from basic to advanced.

**SHOWER SPECIFICATIONS**

Visit [spray.com/specsheets](http://spray.com/specsheets) to download specification sheets or contact your local spray expert to discuss your application needs.

QUICK REFERENCE GUIDE

Shower Type	Materials of Construction	Nozzle Compatibility	Ideal For
<b>Automatic Brush</b>	Pipe: 304 stainless steel or 316 stainless steel	ShowerJet, plus a wide variety of nozzles	Hard-to-reach brush showers in forming and press sections
<b>PulsaJet® Manifold</b>	Anodized aluminum	PulsaJet automatic spray nozzles	Converting applications and fine control over application rate of expensive chemistries
<b>Web Lamination</b>	Header: Anodized aluminum Wetted components: Anodized aluminum, stainless steel, Viton®, Buna®, nylon, nickel-plated brass	1/8JJAU	Spraying glues for web lamination
<b>AutoJet® Oscillator Shower Assembly</b>	Wetted components: 316 stainless steel Bearings: PTFE	Self-cleaning, ShowerJet, DiscJet® nozzles and more	Upgrading fabric cleaning showers in press and forming sections
<b>Air Atomizing</b>	316 stainless steel	VMAU, VAU, VAA, 1/4JAU with plate mount, AirJet® fogger nozzles	Difficult-to-spray solutions, very low flow rates, or remoisturizing showers
<b>Pipe-in-Pipe Air Atomizing</b>	Pipe: 304 stainless steel or 316 stainless steel	1/8JJAU and 1/4JAU automatic spray nozzles with integrated check valves and strainers	Economical remoisturizing showers
<b>Brushless</b>	Pipe: 304 stainless steel or 316 stainless steel	Self-cleaning, ShowerJet, DiscJet nozzles and more	Entry level chemical or lubrication showers for press and forming section

**SHOWER SPECIFICATIONS**

Visit [spray.com/specsheets](http://spray.com/specsheets) to download specification sheets or contact your local spray expert to discuss your application needs.













# SHOWER NOZZLES

## TABLE OF CONTENTS

	PAGE
 ShowerJet One-piece, High-pressure	C3
 ShowerJet Disc-type	C4
 Lock Rings	C5
 NeedleJet Nozzles	C6
 DiscJet® Nozzles	C8
 Self-Cleaning Nozzles	C9

**SHOWER NOZZLES**

**QUICK REFERENCE GUIDE**

**QUICK REFERENCE GUIDE**

Model Standard (Metric)	Connection/ Type	Connection/ Thread Size in. (mm)	Flow Rate Range gpm (lpm)	Max. Operating Pressure psi (bar)	Spray Angle	Materials
<b>ShowerJet One-piece, High-pressure Nozzles</b>						
<b>73196 (M73196)</b>	M	1-3/16"-18 (M30 x 1.5)	.02 to 1.12 gpm (.08 to 4.24 lpm)	800 psi (55 bar)	0° at 40 psi (3 bar)	316 stainless steel body with synthetic ruby orifice
<b>73327 (M73327)</b>	M	1-1/4"-18 (M32 x 1.5)				
<b>37337 (M37337)</b>	M	1-3/16"-18 (M30 x 1.5)				
<b>38553 (M38553)</b>	M	1-1/4"-18 (M32 x 1.5)				
<b>39468</b>	M	1-3/8"-12				316 stainless steel body and orifice
<b>ShowerJet Disc-type Nozzles</b>						
<b>27149</b>	Disc type	NA	.03 to 55 gpm (.11 to 208 lpm)	800 psi (55 bar)	0° to 75° at 60 psi (4 bar)	316L stainless steel body and orifice
<b>39350</b>	Disc type	NA	.02 to 1.12 gpm (.08 to 4.24 lpm)		0° at 40 psi (3 bar)	316 stainless steel body with ceramic orifice
<b>48546</b>	Disc type	NA				316L stainless steel body with synthetic ruby orifice
<b>50790</b>	Disc type	NA				316L stainless steel body and orifice
<b>39485</b>	Disc type	NA				
<b>ShowerJet Lock Rings</b>						
<b>27044</b>	M	See page C5	NA	NA	NA	316 stainless steel
<b>31250</b>	M	See page C5				
<b>28376</b>	M	See page C5				
<b>NeedleJet Nozzles – Tapered Front</b>						
<b>48460</b>	M	9/16"-24	.032 to 11.0 gpm (.12 to 41.6 lpm)	1000 psi (70 bar)	0° at 40 psi (3 bar)	316 stainless steel body with synthetic ruby orifice
<b>19124</b>	M	9/16"-24				316 stainless steel body and orifice
<b>P36503</b>	M	1/4" BSPP				
<b>NeedleJet Nozzles – Longer Length</b>						
<b>56740</b>	M	1/8" BSPP	.032 to 11.0 gpm (.12 to 41.6 lpm)	1000 psi (70 bar)	0° at 40 psi (3 bar))	316 stainless steel body with synthetic ruby orifice
<b>48277</b>	M	1/8"				316 stainless steel
<b>21280</b>	M	9/16"-24 NEF				316 stainless steel nozzle and extension tube
<b>39458</b>	M	9/16"-24 NEF				316 stainless steel nozzle and extension tube with ceramic orifice
<b>NeedleJet Nozzles – Compact</b>						
<b>22812</b>	M	1/8"	.032 to 11.0 gpm (.12 to 41.6 lpm)	1000 psi (70 bar)	0° at 40 psi (3 bar)	316 stainless steel body and orifice
<b>20094</b>	M	1/4"-28 UNF				
<b>DiscJet® Nozzles</b>						
<b>DK</b>	Disc type	Threadless	.025 to 16.7 gpm (.09 to 63.22 lpm)	150 psi (10 bar)	0° to 90° at 40 psi (3 bar)	303 stainless steel or 316 stainless steel
<b>DJ</b>	M	5/8"-18			25° to 110° at 40 psi (3 bar)	
<b>48284</b>	Disc type	Threadless			316 stainless steel	
<b>25834</b>	Disc type	Threadless				
<b>Self-cleaning Nozzles</b>						
<b>20210</b>	M	1-1/8"-20	.008 to 12.6 gpm (.03 to 47.7 lpm)	250 psi (17 bar)	0° to 130° at 40 psi (3 bar)	316 stainless steel deflector, body, piston, nut and spring
<b>20235</b>	M	3/4"-20				



**SHOWERJET ONE-PIECE, HIGH-PRESSURE**

**SHOWER NOZZLES**

**OVERVIEW: SHOWERJET ONE-PIECE, HIGH-PRESSURE NOZZLES**

**Ideal for: easy replacement of ShowerJet and most other manufacturer showers**

- Consolidated nozzle design eliminates the separate nut and gasket. All-in-one design saves time during installation and removal
- Faster and easier installation into the header using a 3/8" (9.5 mm) hex wrench
- Available in a variety of body lengths
- Powerful solid stream spray from .02 to 1.12 gpm (.08 to 4.24 lpm)
- Operating pressures up to 800 psi (55 bar)

**ONE-PIECE, HIGH-PRESSURE NOZZLE OPTIONS**



**73196 & 73327**

Solid stream spray pattern  
 Ruby orifice for longer wear life  
 Integral lock rings



**37337, 38553 & 39468**

Solid stream spray pattern  
 Stainless steel orifices

**QUICK REFERENCE GUIDE**

Model Standard (Metric)	Connection Thread Size in. (mm)	Flow Rate Range gpm (lpm)	Materials
<b>73196 (M73196)</b>	1-3/16"-18 (M30 x 1.5)	.02 to 1.12 gpm (.08 to 4.24 lpm)	316 stainless steel body with synthetic ruby orifice
<b>73327 (M73327)</b>	1-1/4"-18 (M32 x 1.5)		
<b>37337 (M37337)</b>	1-3/16"-18 (M30 x 1.5)		316 stainless steel body and orifice
<b>38553 (M38553)</b>	1-1/4"-18 (M32 x 1.5)		
<b>39468</b>	1-3/8"-12		

FOR DETAILED NOZZLE PERFORMANCE DATA, SEE [spray.com/papercatalog/performance](http://spray.com/papercatalog/performance)

**OVERVIEW: SHOWERJET DISC-TYPE NOZZLES**

**Ideal for: use with automatic brush showers**

- Disc-type nozzles fit inside the shower; the internal brushes easily sweep debris away
- Lock ring holds the nozzles in place
- Available in flat and solid stream spray patterns
- Solid stream versions: Choose from ceramic, stainless steel or synthetic ruby orifice material for longer wear life
- Notches on flat spray version allow removal of installed nozzles from the base with a flathead screwdriver – a Spraying Systems Co. exclusive
- All ShowerJet nozzles are installed with a standard gasket which is included, CP28624-001
- 27149 provides uniform spray distribution from .03 to 55 gpm (.11 to 208 lpm)
- 39350, 48546, 50790 & 39485 powerful solid stream spray from .02 to 1.12 gpm (.08 to 4.24 lpm)
- Operating pressures up to 800 psi (55 bar)

**DISC-TYPE NOZZLE OPTIONS**

**27149**

- Notched flats for easy removal
- Flat spray pattern
- 316L stainless steel orifice



**39350**

- Dome shape
- Solid stream spray pattern
- Ceramic orifice



**48546**

- Dome shape
- Solid stream spray pattern
- 316L stainless steel body; synthetic ruby orifice

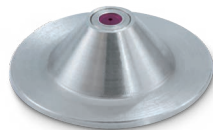

**50790 & 39485**

- Low profile design
- Solid stream spray pattern
- 50790 has a 316L stainless steel body and synthetic ruby orifice; 39485 has a 316L stainless steel body and orifice
- Order 50790 for Stamm showers; 50790-1 for Spraying Systems Co. showers



FOR DETAILED NOZZLE PERFORMANCE DATA, SEE [spray.com/papercatalog/performance](http://spray.com/papercatalog/performance)

LOCK RING OPTIONS

27044 and 31250

- 27044 for use with Spraying Systems Co. shower bases
- 31250 for use with shower bases from other manufacturers



Model	Thread Size	For Shower Headers Supplied By
CP27044-001-316SS	1-3/16"-18 UNEF	SSCo. Standard/NASH-CVN
CP27044-002-316SS	1-3/16"-18 UNEF	SSCo. 75° ShowerJet
CP31250-001-316SS	M32 x 1.5	Valmet
CP31250-002-316SS	M30 x 1	Stamm
CP31250-003-316SS	1-1/4"-18 UNEF	Lechler
CP31250-005-316SS	M30 x 1.5	Voith

28376, 29676 and 29677

- Convert existing showers to alternate nozzles as needs change
- Can be used with dome strainer 28900 when on a brush header
- Thread sizes for Spraying System Co and competitive showers

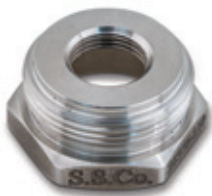

Part Number	"A" Thread	"B" Thread
28376-1/4-316SS	1/4"	1-3/16"-18
28376-3/8-316SS	3/8"	1-3/16"-18
28376-110-316SS	9/16"-24	1-3/16"-18
29676-1/4-316SS	1/4"	1-1/4"-18
29676-3/8 x 1-1/4-316SS	3/8"	1-1/4"-18
29676-1/4 x M30 x 1-316SS	1/4"	M30 x 1.0
29676-103-316SS	9/16"-24	M30 x 1.0
29676-1/4 x M30 x 1.5-316SS	1/4"	M30 x 1.5
29676-1/4 x M32 x 1.5-316SS	1/4"	M32 x 1.5
29676-1/8 x M32 x 1.5-316SS	1/8"	M32 x 1.5
29676-202-316SS	9/16"-24	M32 x 1.5
29677-P x 1-1/8-316SS	PLUG	1-1/8"-20
29677-1/4 x 1-3/4-316SS	1/4"	1-3/4"-8

FOR DETAILED NOZZLE PERFORMANCE DATA, SEE [spray.com/papercatalog/performance](http://spray.com/papercatalog/performance)



**OVERVIEW: NEEDLEJET NOZZLES**



**Ideal for: effectively cleaning and washing of felts, fabric/wire and suction rolls**

- High-performance NeedleJet nozzles provide powerful solid stream sprays to effectively clean and wash felts, fabric/wire and suction rolls
- Precision-machined to provide tight flow control
- For use with a wide range of showers, including oscillating
- Versions with tubes or extensions in the back end that protrude higher into the shower. This enables better quality water to be drawn into the nozzle and minimizes turbulence
- Powerful solid stream spray from .032 to 11.0 gpm (.12 to 41.6 lpm)
- Operating pressures up to 1000 psi (70 bar)

**NEEDLEJET NOZZLE OPTIONS**







**STYLES**

Model	Model Type	Description	Connection Thread Size	Hex in. (mm)	Materials
	<b>48460</b>	Tapered front	9/16"-24 NEF	11/16 (17.5)	316 stainless steel body with synthetic ruby orifice
	<b>19124</b>	Tapered front	9/16"-24 NEF	11/16 (17.5)	316 stainless steel
	<b>P36503</b>	Tapered front	1/4" BSPP	11/16 (17.5)	316 stainless steel

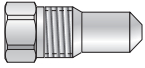
NEEDLEJET

SHOWER NOZZLES

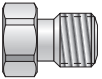
Model	Model Type	Description	Connection Thread Size	Hex in. (mm)	Materials
	<b>56740</b>	Longer length design	1/8" BSPP	7/16 (11.1)	316 stainless steel body with synthetic ruby orifice
	<b>48277</b>	Longer length design with extended inlet	1/8"	7/16 (11.1)	316 stainless steel
	<b>21280</b>	Longer length design with extended inlet	9/16"-24 NEF	11/16 (17.5)	316 stainless steel – nozzle and extension tube
	<b>39458</b>	Longer length design with extended inlet	9/16"-24 NEF	11/16 (17.5)	316 stainless steel nozzle and extension tube; ceramic orifice
	<b>22812</b>	Compact design; front of nozzle is flat, not rounded	1/8"	7/16 (11.1)	316 stainless steel
	<b>20094</b>	Compact design	1/4"-28 UNF	5/16 (7.9)	316 stainless steel

FOR DETAILED NOZZLE PERFORMANCE DATA, SEE [spray.com/papercatalog/performance](http://spray.com/papercatalog/performance)



OVERVIEW: DISCJET NOZZLES

Ideal for: fitting into tight spaces

- DiscJet nozzles are ideal for when space is tight; nozzle flush mounts in shower
- Compact design provides uniform coverage
- Provides effective cleaning with minimal water use
- Entrance to orifice designed to prevent clogging
- Offset 5° from shower axis to avoid interference with adjacent sprays
- For use with 46143 retainer cap and 46144 gasket
- Powerful solid stream spray from .025 to 16.7 gpm (.09 to 63.22 lpm)
- Operating pressures up to 150 psi (10 bar)

DISCJET NOZZLE OPTIONS



**DK versions**

Flat spray pattern  
Threadless connection  
.125 thickness



**DJ versions**

Flat spray pattern  
5/8"-18 threaded connection  
.125 thickness



**48284**

Solid stream  
Threadless connection  
.125 thickness



**25834**

Solid stream  
Threadless connection  
.095 thickness

FOR DETAILED NOZZLE PERFORMANCE DATA, SEE  
[spray.com/papercatalog/performance](http://spray.com/papercatalog/performance)



**OVERVIEW: SELF-CLEANING NOZZLES**

**Ideal for: use in environments with suspended solids and showers with high solids content in the water**

- For use with white water on save-all and knock-off showers
- Features a piston-type design. When line pressure is low, the nozzle's piston retracts to purge debris from the nozzle orifice
- Available with low or high actuator pressures
- Compact design fits easily inside paper machines
- Fast, easy installation and alignment
- Uniform spray distribution from .008 to 12.6 gpm (.03 to 47.7 lpm)
- Operating pressures up to 250 psi (17 bar)

**SELF-CLEANING NOZZLE OPTIONS**

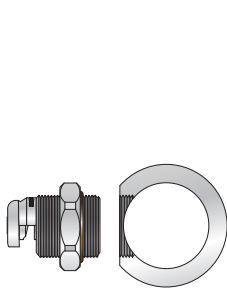

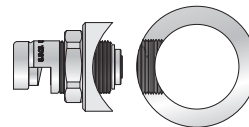

With interface for flat face showers



With interface for round showers

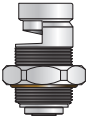

**STYLES**

Model	Model Type	Spray Pattern	Description	Connection Thread Size	Hex in. (mm)	Materials
	<b>20210</b>	Flat and solid stream	Hex nut with O-ring for interface with flat face on shower headers	1-1/8"-20 UN	1-1/2 (38.1)	316 stainless steel body with 302 stainless steel spring, Buna-N O-ring and Fairprene® diaphragm
	<b>20235</b>	Flat	Hex nut with polypropylene saddle gasket for interface with round shower headers	3/4"-20 UNEF	1 (25.4)	316 stainless steel body with 302 stainless steel spring, silicone rubber diaphragm and polypropylene saddle gasket
	<b>26225</b>	Flat and solid stream	Hex nut with O-ring interface with flat face on shower	3/4"-20 UNEF	1 (25.4)	316 stainless steel body and spring, Viton® O-ring and silicone rubber diaphragm

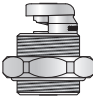
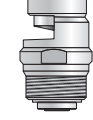

STYLES

Model	Model Type	Spray Pattern	Description	Connection Thread Size	Hex in. (mm)	Materials
	<b>26411</b>	Flat	Solid stream pattern: hex nut with O-ring	3/4" BSPP	1-1/2 (38.1)	316 stainless steel body and spring, Viton® O-ring and natural rubber diaphragm
	<b>36090</b>	Flat and solid stream	Hex nut with O-ring interface with flat face on shower	M28 x 1.5	1-1/2 (38.1)	316 stainless steel body with 302 stainless steel spring, Buna-N O-ring and Fairprene® diaphragm
	<b>38332</b>	Flat	Self-sealing design for interface with any shower header	3/4"	1-1/16 (27)	316 stainless steel body and spring, silicone rubber diaphragm
	<b>38490</b>	Double solid stream*	Hex nut with O-ring interface with flat face on shower	1-1/8"-20 UN	1-1/2 (38.1)	316 stainless steel body and spring, Buna-N O-ring and Fairprene diaphragm
	<b>49905</b>	Double flat spray*	Hex nut with O-ring interface with flat face on shower	1-1/8"-20 UN	1-1/2 (38.1)	316 stainless steel body with 302 stainless steel spring, Buna-N O-ring and Fairprene diaphragm
	<b>49905-1</b>			M28 x 1.5		
	<b>72370</b>	Flat	Self-sealing design for interface with any shower header that has 1/2" NPT ports	1/2" NPT (male)	.812 (20.9) flats	316 stainless steel body with 302 stainless steel spring, silicone rubber diaphragm

\* Capacity size is for the entire nozzle assembly.



FOR DETAILED NOZZLE PERFORMANCE DATA, SEE [spray.com/papercatalog/performance](http://spray.com/papercatalog/performance)

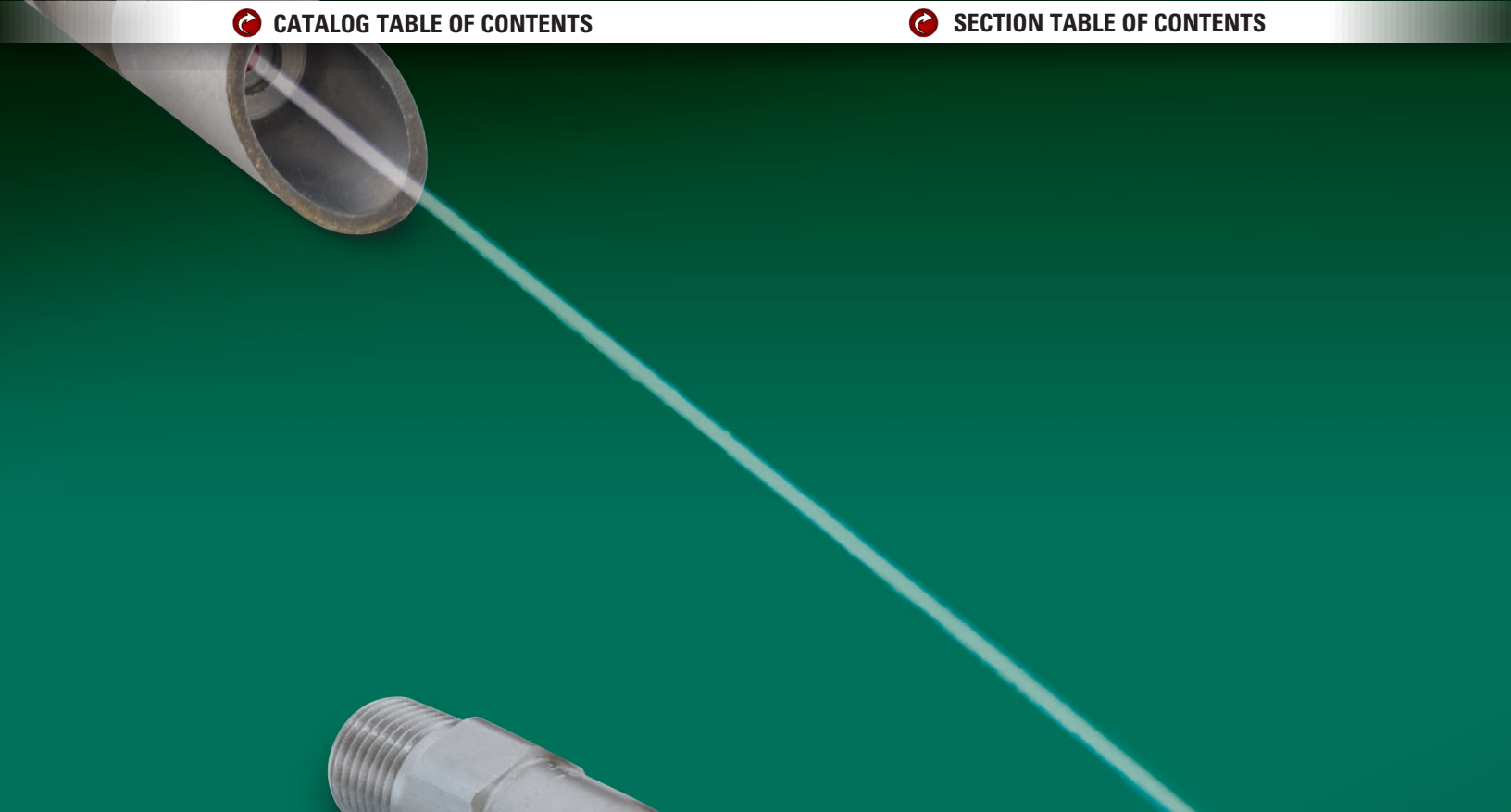



# WEB TRIMMING NOZZLES

## TABLE OF CONTENTS

	PAGE
 UltraStream® Nozzles	D2
 UltraStream Nozzle Accessories	D3
 UltraStream Alignment Devices	D4









**OVERVIEW: ULTRASTREAM NOZZLES**

**Ideal for: edge trimming, cutting and slitting**

- Single orifice version suitable with most paper grades
- Dual orifice versions:
  - Provide twin parallel solid stream sprays for precise edge trimming on fine and specialty papers
  - Eliminate the need for two nozzles used in tandem, reduce backsplash and simplify spray alignment
  - Feature ruby orifices for long-lasting durability
- 38170 single orifice nozzle with strainer helps minimize clogging which is especially helpful when using recirculated water
- Powerful, needle-like solid stream spray
- Nozzles can be placed further away from target to reduce buildup
- Swivel nozzle 39610 or swivel adapter 39290 can be used to align dual orifice nozzles and correctly move a drip shield to the outside of the paper web
- Nozzles 39610, 72242, 58035-2 and 56795-2 feature a shrouded orifice for protection, ease of alignment and help in guiding buildup away from the moving web
- Powerful solid stream spray from .02 to 2.3 gpm (.08 to 8.7 lpm)
- Operating pressures up to 1000 psi (70 bar)

**ULTRASTREAM NOZZLE OPTIONS**

 <p><b>38170 Single Orifice with Strainer</b> 3/8" male connection Ceramic or 316 stainless steel orifice Brass body and brass strainer body with 304 stainless steel screen</p>	 <p><b>38171 Single Orifice</b> 1/8" male connection Ceramic or 316 stainless steel orifice Brass body</p>	 <p><b>48461 Single Ruby Orifice</b> 1/8" male connection Synthetic ruby orifice and 303 stainless steel body</p>
 <p><b>39610 Single Ruby Orifice Swivel</b> M10 x 0.75 male connection Synthetic ruby orifice and 303 stainless steel body Shrouded orifice with 360° swivel action</p>	 <p><b>72242 Single Ruby Orifice</b> 1/8" male thread connection Synthetic ruby orifice and 303 stainless steel body Shrouded orifice</p>	 <p><b>58035-2 and 56795-2 Dual Ruby Orifice</b> 1/8" male or female connection Synthetic ruby orifice and 303 stainless steel body Shrouded orifice</p>

**QUICK REFERENCE GUIDE**

Model	Orifice	Connection/Type	Connection Size	Flow Rate Range gpm (lpm)	Max. Operating Pressure psi (bar)	Spray Angle	Materials
<b>38170</b>	Single	M	3/8"	.02 to 2.3 gpm (.08 to 8.7 lpm)	1000 psi (70 bar)	0° at 100 psi (4 bar)	Brass body with ceramic or 316 stainless steel orifice, 304 stainless steel screen
<b>38171</b>	Single	M	1/8"				Brass body with ceramic or 316 stainless steel orifice
<b>48461</b>	Single	M	1/8"				303 stainless steel body with synthetic ruby orifice
<b>39610 Swivel</b>	Single	M	M10 x 0.75				
<b>72242</b>	Single	M	1/8"				
<b>58035-2, 56795-2</b>	Dual	M/F	1/8"	.04 to 1.52 gpm (.15 to 5.75 lpm)			



**OVERVIEW: ULTRASTREAM NOZZLE ACCESSORIES**

- Simplify installation and speed set-up by purchasing accessories and nozzles together
- Improve precision, optimize system performance and minimize paper breaks

**ULTRASTREAM NOZZLE ACCESSORY OPTIONS**

**115425 and 115427 Trimming Feed Converter**

- Convert trimming feeds back and forth between 1/8" to M10 x 0.75 threads
- Retrofit existing installed M10 thread bases
- 115425 - Convert M10 base for 1/8" nozzle
- 115427 - Convert 1/8" base for M10 nozzle
- 303 stainless steel body



**39290 Swivel Adapter**

- Add swivel functionality to any 1/8" UltraStream nozzle
- 303 stainless steel body
- Suitable for use with single orifice ruby nozzle 72242 or dual orifice ruby nozzle 56795-2



**87529 Air Barrier Adapter  
Shown with 48461 UltraStream**

- Prevents buildup on trim nozzles with a shroud of compressed air
- 1/8" compressed air connection
- 2 to 7 psi (0.14 to 0.48 bar) required for operation
- Can be use with any single or dual orifice UltraStream nozzle
- 303 or 316 stainless steel body



**QUICK REFERENCE GUIDE**

Model	Connection/Type	Inlet Connection Size/Type	Outlet Connection Thread Size/Type	Materials
<b>115425</b>	Inlet M Outlet F	M10 x 0.75	1/8"	303 stainless steel
<b>115427</b>	Inlet M Outlet F	1/8"	M10 x 0.75	303 stainless steel
<b>39290</b>	Inlet M Outlet F	M10 x 0.75	1/8"	303 stainless steel
<b>87529</b>	Inlet M Outlet F	1/8", 1/4", M10 x 0.75	1/8", M10 x 0.75	303 or 316 stainless steel

FOR DETAILED NOZZLE PERFORMANCE DATA, SEE [spray.com/papercatalog/performance](http://spray.com/papercatalog/performance)

**OVERVIEW: ALIGNMENT DEVICES FOR ULTRASTREAM NOZZLES**

**Ideal for: edge trimming**

- Quick and easy adjustment of UltraStream® nozzles to the exact trim position reduces downtime for nozzle alignment up to 70%
- Use with different paper widths and grades; horizontal and rotational adjustments can be made quickly and accurately in 10 mm increments to ensure precise control of nozzle location – no tools required
- Record final positions to ensure repeatable performance using calibration devices
- Improve operator safety – handles and scales are located away from the nozzles
- Multi-pipe alignment device provides a redundant stream to prevent sheet breaks due to spitting or broken streams
- Goose-necked pipe design prevents turbulence in pipe before nozzle
- Set-up is simple – UltraStream nozzles attach easily to arms; alignment arms can be removed without disrupting remaining arms and nozzle locations
- For use with single or dual UltraStream nozzles with or without 38170 strainers
- Stainless steel construction

**ALIGNMENT DEVICE OPTIONS**

**Multi-pipe Alignment Device 115450**

3/8" outlet; 1/4" inlet

Individual pipe horizontal adjustment range: 7.9" (200 mm)

Multi-pipe slider horizontal adjustment range: 7.9" (200 mm)

Individual pipe rotational adjustment range: ± 40°

Two pipe units available upon request

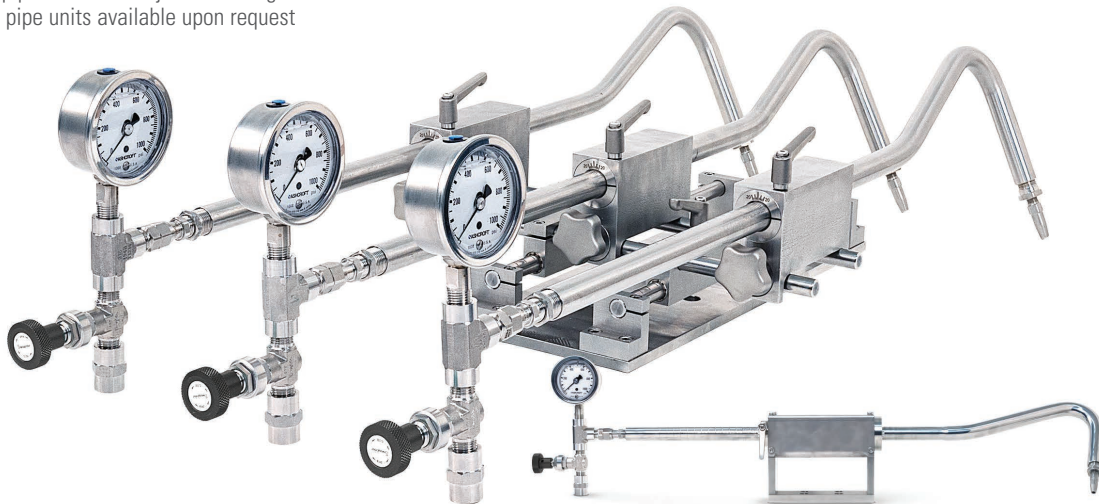

Precise control of nozzle location is easily accomplished using the rotational and horizontal scales



**PLACING YOUR ORDER**

**Call your local spray expert for application assistance or to place an order.**

**Single-pipe Alignment Device Y72020**

3/8" outlet; 1/4" inlet









Horizontal pipe adjustment range: 7.9" (200 mm)

Pipe rotational adjustment range: ± 40°



# FLAT SPRAY NOZZLES

## TABLE OF CONTENTS

	PAGE		PAGE
<b>STANDARD SPRAY NOZZLES</b>		<b>NARROW ANGLE SPRAY</b>	
 VeeJet® Nozzles	E4	 FloodJet® Wide Angle Spray Nozzles	E10
 Quick-Change Nozzles: QuickJet® & UniJet®	E5	 FlatJet® Narrow Angle Spray Nozzles	E11
 Quick-Change Nozzles: UniJet	E6	 Quick-Change Nozzles: QuickJet	E12
 Black Liquor Nozzles	E7		
<b>WIDE ANGLE SPRAY</b>			
 Quick-Change Nozzles: QuickJet & UniJet	E8		
 Quick-Change Nozzles: UniJet	E9		



FLAT SPRAY

FLAT SPRAY NOZZLES

**S** STANDARD ANGLE SPRAY

QUICK REFERENCE GUIDE

Model	Connection/ Type	Connection Size in.	Flow Rate Range gpm (lpm)	Max. Operating Pressure psi (bar)	Spray Angle	Materials
<b>S</b> STANDARD ANGLE SPRAY						
<b>VeeJet® Nozzles</b>						
<b>H-DT nozzle</b>	F	1/8 to 1/4	.012 to 5.3 gpm (.047 to 20.06 lpm)	500 psi (35 bar)	0° to 110° at 40 psi (3 bar)	Brass, 303 stainless steel
<b>H-DU nozzle</b>	F	1/8 to 1/4	.07 to 1237 gpm (.26 to 4720 lpm)			Brass, 303 stainless steel, polyvinyl chloride
<b>H-VV nozzle</b>	M	1/8 to 1/4	.012 to 5.3 gpm (.047 to 20.06 lpm)			Brass, mild steel, 303 stainless steel, 316 stainless steel
<b>H-VVL nozzle</b>	M	1/8 to 1/4				Brass, 303 stainless steel, 316 stainless steel
<b>U nozzle</b>	M	1 to 2	17.7 to 1237 gpm (67 to 4720 lpm)			Brass, mild steel, 303 stainless steel
<b>Quick-Change QuickJet® Nozzles</b>						
<b>QUA spray tip</b>	Use with QJA or QJJA bodies	NA	.11 to 22 gpm (.42 to 83.28 lpm)	300 psi (20 bar)	0° to 95° at 40 psi (3 bar)	Brass, 303 stainless steel
<b>QVVA spray tip</b>	Use with QJA or QJJA bodies	NA	.003 to 41 gpm (.01 to 155.2 lpm)			
<b>58106 spray tip</b>	Use with QJA or QJJA bodies	NA	.003 to 2.2 gpm (.01 to 8.33 lpm)			0° to 110° at 40 psi (3 bar)
<b>QJA body</b>	F	1/8 to 1/2	NA	NA	NA	Brass, 303 stainless steel
<b>QJJA body</b>	M	1/8 to 1/2	NA	NA	NA	
<b>Quick-Change UniJet® Nozzles</b>						
<b>TPU spray tip</b>	Use with T or TT bodies	NA	.003 to 25 gpm (.01 to 94 lpm)	500 psi (35 bar)	0° to 110° at 40 psi (3 bar)	Brass, stainless steel
<b>13802 spray tip</b>	Use with 14234 bodies	NA				Brass, 303 stainless steel, 316 stainless steel
<b>58102 spray tip</b>	Dovetail tip; threaded and weld body options	NA	.012 to 2.8 gpm (.05 to 10.6 lpm)		15° to 110° at 40 psi (3 bar)	Brass, stainless steel, 316 stainless steel
<b>49803 spray tip</b>	Dovetail tip; threaded and weld body options	NA	.35 to 25 gpm (1.3 to 94 lpm)			Brass, stainless steel, hardened stainless steel
<b>T body/cap</b>	F	1/8 to 1/2	NA	NA	NA	Brass, 303 stainless steel
<b>TT body/cap</b>	M	1/8 to 1/2	NA	NA	NA	
<b>14234 body</b>	F	1/8 to 1/2	NA	NA	NA	
<b>Black Liquor Nozzles</b>						
<b>45824</b>	M	1-1/4 or 1-1/2	60 to 150 gpm (227 to 568 lpm)	10 psi (.7 bar)	130° at 10 psi (.7 bar)	309 stainless steel
<b>U</b>	M	1-1/4	17.7 to 354 gpm (67 to 1340 lpm)	500 psi (35 bar)	15° to 65° at 40 psi (3 bar)	310 stainless steel





**FLAT SPRAY NOZZLES**

**W** WIDE ANGLE SPRAY

**N** NARROW ANGLE SPRAY

**FLAT SPRAY**

**QUICK REFERENCE GUIDE**

Model	Connection/Type	Connection Size in.	Flow Rate Range gpm (lpm)	Max. Operating Pressure psi (bar)	Spray Angle	Materials
<b>W</b> WIDE ANGLE SPRAY						
Quick-Change QuickJet® Nozzles						
<b>QTKA spray tip</b>	Use with QJA or QJJA bodies	NA	.01 to 14.7 gpm (.037 to 55 lpm)	60 psi (4 bar)	73° to 153° at 10 psi (.7 bar)	Brass, 303 stainless steel
<b>QSTK spray tip</b>	Use with QJJS body	NA				
<b>QJA body</b>	F	1/8 to 1/2	NA	NA	NA	
<b>QJJS body</b>	M	1/8 to 1/4	NA	NA	NA	
<b>QJJA body</b>	M	1/8 to 1/2	NA	NA	NA	
Quick-Change UniJet® Nozzles						
<b>TK spray tip</b>	Use with T or TT bodies	NA	.06 to 12.2 gpm (.28 to 46 lpm)	60 psi (4 bar)	73° to 153° at 10 psi (.7 bar)	Brass, 303 stainless steel
<b>T body/cap</b>	F	1/8 to 1/2	NA	NA	NA	
<b>TT body/cap</b>	M	1/8 to 1/2	NA	NA	NA	
FloodJet® Nozzles						
<b>K nozzle</b>	M	1/8 to 1	.04 to 110 gpm (.14 to 410 lpm)	60 psi (4 bar)	73° to 153° at 10 psi (.7 bar)	Brass, 303 stainless steel, 316 stainless steel, polyvinyl chloride
<b>11499 nozzle</b>	M	1/8	.17 to 4.4 gpm (.64 to 16.66 lpm)		98° to 133° at 10 psi (.7 bar)	316 stainless steel
<b>13063 nozzle</b>	M	1/8	.17 to 2.4 gpm (.64 to 9.1 lpm)			
<b>N</b> NARROW ANGLE SPRAY						
FlatJet® Standard Nozzles						
<b>P nozzle</b>	M	1/8 to 3/4	.24 to 39 gpm (.91 to 144 lpm)	150 psi (10 bar)	15° to 50° at 40 psi (3 bar)	Brass, mild steel, 303 stainless steel, 316 stainless steel
<b>RotoClean 115220 nozzle</b>	M	3/8	1.2 to 7.7 gpm (4.54 to 29.15 lpm)	100 psi (7 bar)	35° or 50° at 40 psi (3 bar)	316 stainless steel
Quick-Change QuickJet Nozzles						
<b>QLPA spray tip</b>	Use with QJLA or QJJLA bodies	NA	3.7 to 59 gpm (14.01 to 223 lpm)	100 psi (7 bar)	25° to 60° at 40 psi (3 bar)	Brass, 303 stainless steel, 316 stainless steel
<b>QJLA body</b>	F	3/8 to 1/2	NA	NA	NA	
<b>QJJLA body</b>	M	3/8 to 1/2	NA	NA	NA	



**OVERVIEW: VEEJET NOZZLES**

**Ideal for: roll lubrication, chemical shower and edge decks**

- Widely used in showers, flat spray nozzles provide a fan-type, tapered-edge pattern to ensure even coverage when multiple nozzles are used in a series
- Solid stream (0° spray angle) versions achieve the highest impact of any nozzle type
- Consistent performance over a large range of flow rates and pressures
- Uniform spray distribution with flow rates from .012 to 1237 gpm (.047 to 4720 lpm)
- Operating pressures up to 500 psi (35 bar)

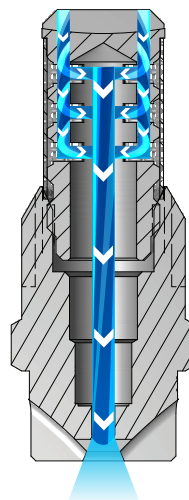

**VeeJet Nozzles**

As the liquid exits through the sharp V shape cut of the orifice, it forms into a flat spray pattern. The distribution is tapered from the center of the spray.

**VEEJET NOZZLE OPTIONS**

S



**H-VV**

1/8" to 1/4" male conn.  
Flow rates below 1 gpm at 40 psi  
(3.8 lpm at 2.8 bar)

S



**H-DT**

1/8" to 1/4" female conn.  
Flow rates below 1 gpm at 40 psi  
(3.8 lpm at 2.8 bar)

S



**H-DU**

1/8" to 1/4" female conn.  
Flow rates of 1 gpm and greater at 40 psi  
(3.8 lpm and greater at 2.8 bar)

S



**H-VVL**

1/8" to 1/4" male conn.  
Flow rates below 1 gpm at 40 psi  
(3.8 lpm at 2.8 bar)  
H-VVL includes integral strainer

S



**U**

1" to 2" male conn.  
Flow rates of 50 gpm and greater at 40 psi  
(189.3 lpm and greater at 2.8 bar)

FOR DETAILED NOZZLE PERFORMANCE DATA, SEE [spray.com/papercatalog/performance](http://spray.com/papercatalog/performance)



QUICK-CHANGE NOZZLES: QUICKJET® AND UNIJET®

S STANDARD ANGLE SPRAY

FLAT SPRAY

OVERVIEW: QUICK-CHANGE NOZZLES: QUICKJET AND UNIJET STYLES

Ideal for: yankee chemical showers and critical alignment locations

- Perfect for high-maintenance operations – bodies remain on pipe/header
- Flat fan type, tapered edge spray pattern
- Tips compatible with either male or female body
- Spray angles from 0° to 110°
- Quick VeeJet® nozzles allow:
  - Quick quarter-turn removes/installs spray tips in seconds
  - Uniform spray distribution with flow rates from .003 to 22 gpm
  - Operating pressures up to 300 psi (20 bar)
- 58106 features Quick VeeJet connection with roll pin for extra leverage upon installation or removal
- UniJet nozzles allow:
  - Easy tip change out in place – remove tips by unscrewing retainer
  - Uniform spray distribution with flow rates from .003 to 25 gpm
  - Operating pressures up to 500 psi (35 bar)

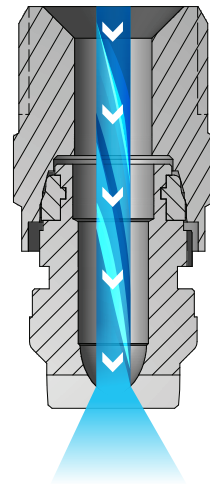

Quick VeeJet Nozzles

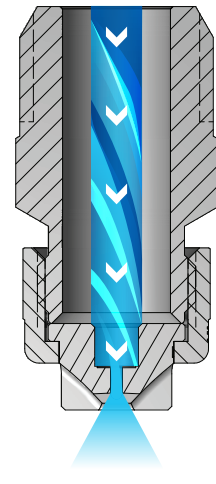

UniJet Nozzles

Quick VeeJet and UniJet Nozzles

As the liquid exits through the sharp V shape cut of the orifice, it forms into a flat spray pattern. The distribution is tapered from the center of the spray.

QUICK-CHANGE QUICKJET NOZZLE OPTIONS

S



**QUA Spray Tip + QJA or QJJA Bodies**  
Flow rates of 1 to 8 gpm at 40 psi  
(3.9 to 32 lpm at 2.8 bar)

S



**QVVA Spray Tip**  
Flow rates below 1 gpm at 40 psi  
(3.9 lpm at 2.8 bar)  
Use with QJA or QJJA bodies

S



**58106 Spray Tip**  
Flow rates below 1 gpm at 40 psi  
(3.9 lpm at 2.8 bar)  
Use with any QuickJet body

S



**QJA Body**  
1/8" to 1/2" female conn.

S



**QJJA Body**  
1/8" to 1/2" male conn.

FOR DETAILED NOZZLE PERFORMANCE DATA, SEE [spray.com/papercatalog/performance](http://spray.com/papercatalog/performance)



FLAT SPRAY

QUICK-CHANGE NOZZLES: UNIJET®

S STANDARD ANGLE SPRAY

UNIJET NOZZLE OPTIONS

S

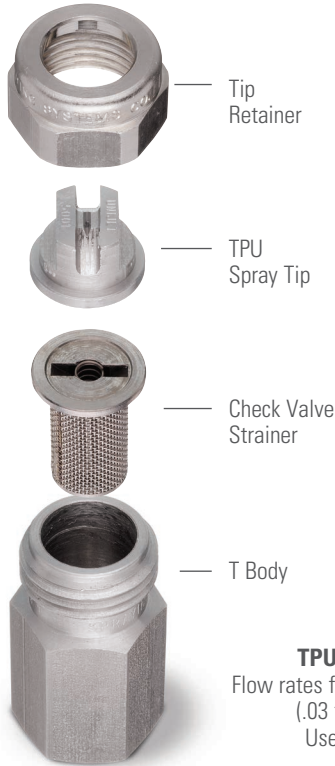

**TPU Spray Tip + T Body**  
 Flow rates from .009 to 7.0 gpm at 40 psi  
 (.03 to 26.5 lpm at 2.8 bar)  
 Use with screen strainer  
 and tip retainer

S



**13802 Spray Tip + 14234 Body**  
 1/8" to 1/2" female conn.  
 Flow rates from .009 to 7.0 gpm at  
 40 psi (.03 to 26.5 lpm at 2.8 bar)  
 Self-aligning tip with wrench flats on top of  
 tip: straight alignment flats connection

S



**58102 Spray Tip**  
 Flow rates below 1 gpm  
 at 40 psi (3.9 lpm at 2.8 bar)  
 Self-aligning tip with wrench flats on  
 top of tip and dovetail connection;  
 spray is offset 5° from dovetail

S



**49803 Spray Tip**  
 Flow rates from .017 to 7.0 gpm at  
 40 psi (.064 to 26.5 lpm at 2.8 bar)  
 Self-aligning tip with round top  
 and dovetail connection:  
 spray flow is 5° from offset



**TT Body/Cap**  
 1/8" to 1/2" male conn.  
 Use with TPU spray tip

Dovetail spray tips can be used on a variety of body types.  
 Please contact your sales engineer for body options and dimensions.

FOR DETAILED NOZZLE PERFORMANCE DATA, SEE  
[spray.com/papercatalog/performance](http://spray.com/papercatalog/performance)



**BLACK LIQUOR NOZZLES**

**S** STANDARD ANGLE SPRAY

**FLAT SPRAY**

**OVERVIEW: BLACK LIQUOR NOZZLES**

**Ideal for: recovery boilers**

- Excellent heat and corrosion resistance
- 45824 Splash Plate Series provide uniform spray distribution from 60 to 150 gpm (227 to 568 lpm)
- VeeJet® U Series provide uniform spray distribution from 17.7 to 354 gpm (67 to 1340 lpm)

**BLACK LIQUOR NOZZLE OPTIONS**

**45824 Splash Plate Series**

- Splash plate design has a large exit orifice for maximum flow passage
- Cast from 309 stainless steel
- Uniform spray distribution from 60 to 150 gpm (227 to 568 lpm)
- Operating pressures up to 10 psi (.7 bar)



**VeeJet U Series**

- VeeJet design provides a flat fan spray pattern
- 50° spray angle at 40 psi (2.8 bar)
- Constructed of 310 stainless steel
- Uniform spray distribution from 17.7 to 354 gpm (67 to 1340 lpm)
- Operating pressures up to 500 psi (35 bar)



**QUICK REFERENCE GUIDE**

Model	Connection/Type	Connection Size in.	Capacity gpm (lpm) at 10 psi (.7 bar)*	Material
<b>45824*</b>	M	1-1/4 or 1-1/2	60-150 (227 - 568)	309 stainless steel
<b>U</b>	M	1-1/4	25-50 (95-189)	310 stainless steel

\*Field studies indicate black liquor flow rates are approx. 50% of water flow rates

FOR DETAILED PERFORMANCE DATA, SEE [spray.com/papercatalog/performance](http://spray.com/papercatalog/performance)

FLAT SPRAY

QUICK-CHANGE NOZZLES: QUICKJET®

**W** WIDE ANGLE SPRAY

**OVERVIEW: QUICK-CHANGE NOZZLES: QUICKJET STYLES**

**Ideal for: uhle box, roll lubrication and chemical showers**

- Perfect for high-maintenance operations – bodies remain on pipe/header
- Wide angle, deflected type flat fan spray pattern
- Quick FloodJet nozzles allow quick quarter-turn removes/installs spray tips in seconds
- Spray angles for 73° to 153°
- Uniform spray distribution from .01 to 14.7 gpm (.037 to 55 lpm)
- Operating pressures up to 60 psi (4 bar)

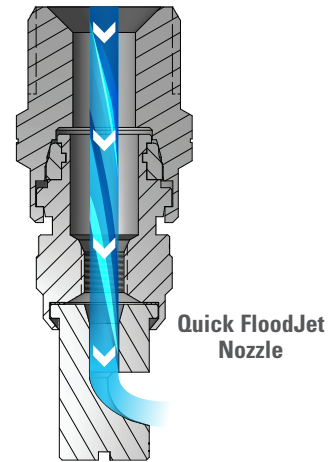

**Quick FloodJet® Nozzles**

The deflector surface enables the formation of very wide spray angles compared to other flat spray nozzles. As liquid passes through the nozzle, it hits the deflector surface and spreads out to form a flat spray pattern. The distribution is even from the center of the spray.

**QUICK-CHANGE QUICKJET OPTIONS**



**Quick FloodJet Nozzle**  
**QTKA Spray Tip + QJA Body**

1/8" to 1/2" female conn.  
Flow rates from .075 to 6.0 gpm at 10 psi  
(.28 to 22.71 lpm at .69 bar)  
Use with QJA or QJJA body



**QSTK Spray Tip**  
Miniature version  
Flow rates below 1 gpm at 40 psi  
(3.9 lpm at 2.8 bar)  
Use with seal and QJJS body



**QJJA Body**  
1/8" to 1/2" male conn.



**QJJS Body**  
Miniature version  
1/8" to 1/4" male conn.

FOR DETAILED NOZZLE PERFORMANCE DATA, SEE  
[spray.com/papercatalog/performance](http://spray.com/papercatalog/performance)

QUICK-CHANGE NOZZLES: UNIJET®

FLAT SPRAY

W WIDE ANGLE SPRAY

**OVERVIEW: QUICK-CHANGE NOZZLES: UNIJET STYLES**

**Ideal for: uhle box, roll lubrication and chemical showers**

- Perfect for high-maintenance operations – bodies remain on pipe/header
- Wide angle, deflected type flat fan spray pattern
- UniJet FloodJet nozzle design allows easy tip change out in place – remove tips by simply unscrewing retainer
- Spray angles for 73° to 153°
- Uniform spray distribution from .06 to 12.2 gpm (.28 to 46 lpm)
- Operating pressures up to 60 psi (4 bar)

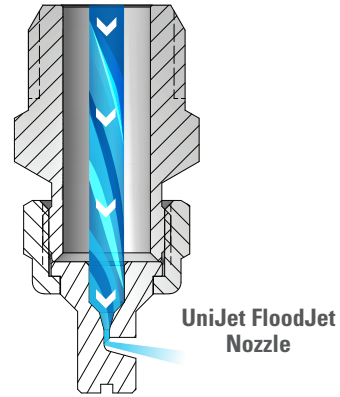

**UniJet FloodJet® Nozzles**

The deflector surface enables the formation of very wide spray angles compared to other flat spray nozzles. As liquid passes through the nozzle, it hits the deflector surface and spreads out to form a flat spray pattern. The distribution is even from the center of the spray.

**QUICK-CHANGE UNIJET OPTIONS**

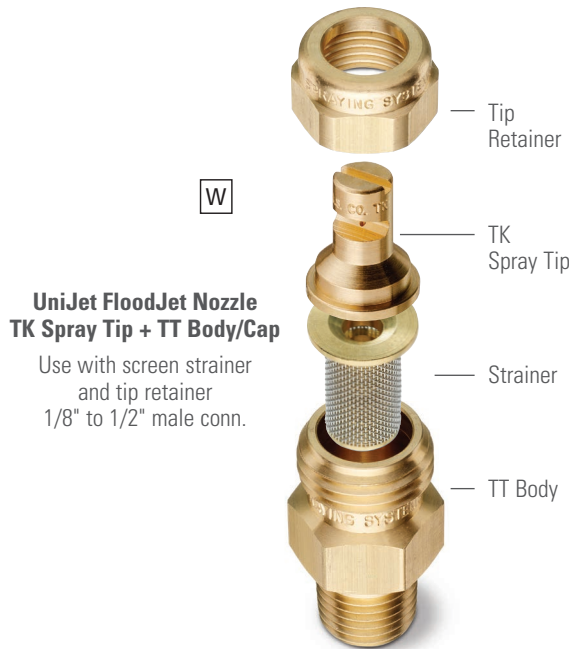

FOR DETAILED NOZZLE PERFORMANCE DATA, SEE [spray.com/papercatalog/performance](http://spray.com/papercatalog/performance)

**OVERVIEW: FLOODJET NOZZLES**

**Ideal for: operations requiring wide coverage, uhle box, roll lubrication and chemical showers**

- Wide angle, deflected type flat fan spray pattern
- Use where nozzles can be mounted horizontally
- Orifice is protected from damage and is designed to minimize clogging
- Alternate nozzle stand off distance to prevent interference, or use longer nozzle series
- Spray angles from 73° to 153°
- Uniform spray distribution from .04 to 110 gpm (.14 to 410 lpm)
- Operating pressures up to 60 psi (4 bar)

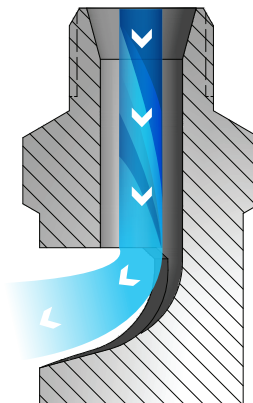

**FloodJet Nozzles**

As liquid passes through the nozzle, it hits the deflector surface and spreads out to form a flat spray pattern. The distribution is even from the center of the spray. The deflector surface enables the formation of very wide spray angles compared to other flat spray nozzles.

**FLOODJET NOZZLE OPTIONS**



**K**  
1/8" to 1" male conn.  
Flow rates below 110 gpm at 60 psi  
(410 lpm at 4.1 bar)



**11499 & 13063**  
1/8" male conn.  
Flow rates below 4.4 gpm at 60 psi  
(16.7 lpm at 4.1 bar)

FOR DETAILED NOZZLE PERFORMANCE DATA, SEE [spray.com/papercatalog/performance](http://spray.com/papercatalog/performance)



**FLATJET® NOZZLES**

**N** NARROW ANGLE SPRAY

**FLAT SPRAY**

**OVERVIEW: FLATJET NOZZLES**

**Ideal for: edge decks, doctor blade cleaning, save all filter mat peeling and flooded nip showers**

- Provides higher impact than other narrow angle nozzles
- Deflected type flat fan spray pattern
- 115220 can be quickly rotated to flush out plugs or debris from orifice and return to a optimal spray pattern
- Spray angles from 15° to 50°
- Uniform spray distribution from .24 to 39 gpm (.91 to 144 lpm)
- Operating pressures up to 150 psi (10 bar)

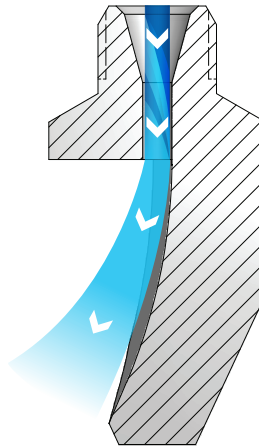

**FlatJet Nozzles**

As liquid passes through the nozzle, it hits the deflector surface and spreads out to form a flat spray pattern. The distribution is even from the center of the spray. The combination of medium- to large-flow rates and narrow spray angles produce a high impact spray.

**FLATJET NOZZLE OPTIONS**

**N**



**P**

3/8" to 3/4" male conn.  
Flow rate from .24 to 39 gpm  
(.91 to 144 lpm)

**N**



**P**

1/8" to 1/4" male conn.  
Flow rate from .24 to 39 gpm  
(.91 to 144 lpm)

**N**



**115220 RotoClean®  
Clean-out Nozzle**

3/8" male conn.  
Flow rate below 7.7 gpm at 150 psi  
(29.15 lpm at 10 bar)

FOR DETAILED NOZZLE PERFORMANCE DATA, SEE  
[spray.com/papercatalog/performance](http://spray.com/papercatalog/performance)



**OVERVIEW: QUICK-CHANGE NOZZLES: QUICKJET**

**Ideal for: uhle box, roll lubrication and chemical showers**

- High-impact flat spray pattern with narrow spray angle, sharply defined edges and uniform spray pattern
- Quick FlatJet® nozzles feature a one-piece spray tip with the convenience of a quick-connect 1/4 turn installation and automatic spray alignment without the use of tools
- Medium-sized drops
- Large unobstructed flow passage minimizes clogging
- Uniform spray distribution from 3.7 to 59 gpm (14 to 223 lpm)
- Operating pressures up to 150 psi (10 bar)

QUICK-CHANGE QUICKJET NOZZLES OPTIONS



**OLPA Spray Tip + QJLA Body**

3/8" to 1/2" female conn.  
 Flow rates below 16 gpm at 150 psi  
 (61 lpm at 10.3 bar)  
 Use with QJLA or QJJLA bodies



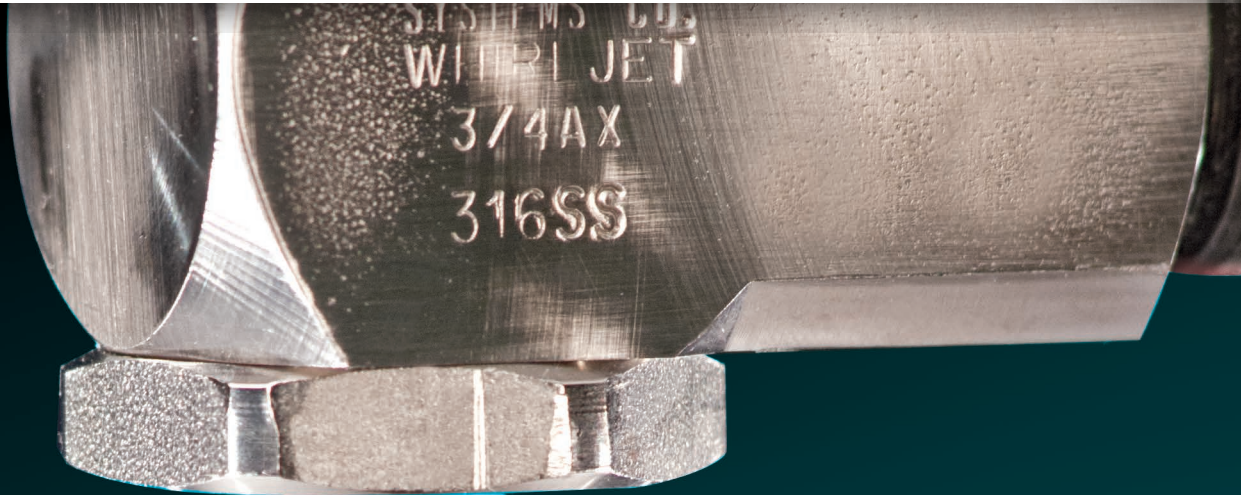

**QJJLA Body**  
 3/8 to 1/2" male conn.

FOR DETAILED NOZZLE PERFORMANCE DATA, SEE [spray.com/papercatalog/performance](http://spray.com/papercatalog/performance)



# HOLLOW CONE NOZZLES

## TABLE OF CONTENTS

	PAGE
 WhirlJet® Nozzles	F3
 SpiralJet® Nozzles	F4



HOLLOW CONE

WHIRLJET® AND SPIRALJET® NOZZLES

**S** STANDARD ANGLE SPRAY | **W** WIDE ANGLE SPRAY

QUICK REFERENCE GUIDE

Model	Connection/Type	Connection Size in.	Flow Rate Range gpm (lpm)	Max. Operating Pressure psi (bar)	Spray Angle	Materials	
<b>S</b> STANDARD ANGLE SPRAY <b>W</b> WIDE ANGLE SPRAY							
<b>WhirlJet Nozzles</b>							
<b>AX</b>	F	1/8 to 3/4	.05 to 38 gpm (.19 to 145 lpm)	100 psi (7 bar)	43° to 91° at 10 psi (.7 bar)	Brass, mild steel, 303 stainless steel, 316 stainless steel	
<b>BX</b>	M	1/8 to 3/4					
<b>AX-W</b>	F	1/8 to 1/2	.05 to 14.2 gpm (.19 to 54 lpm)		112° to 120° at 10 psi (.7 bar)		
<b>BX-W</b>	M	1/8 to 1/2					
<b>BD</b>	M	3/8 to 1-1/2	.11 to 38 gpm (.41 to 143 lpm)	500 psi (34.5)	30° to 91° at 10 psi (.7 bar)	Brass, 303 stainless steel	
<b>BDM</b>	M	3/8	.16 to 9.5 gpm (.61 to 36 lpm)		Nylon, brass cap		
<b>CX</b>	F, Cast	1 to 2-1/2	2.0 to 2362 gpm (7.3 to 9010 lpm)	100 psi (7 bar)	43° to 91° at 7 psi (.5 bar)	Brass, 316 stainless steel	
<b>CF</b>	Flange, Cast	4 to 6					
<b>CRC</b>	F, Cast	1-1/4 to 4					
<b>D</b>	M, Cast	1/2 to 3/4					Brass
<b>AP</b>	F	1/4 to 3/8	.14 to 18.9 gpm (.20 to 15.9 lpm)		43° to 91° at 10 psi (.7 bar)	Polypropylene	
<b>LAP</b>	F	3/8 to 1/2					
<b>LBP</b>	M	3/8	.20 to 5.4 gpm (.75 to 20 lpm)				112° to 120° at 10 psi (.7 bar)
<b>AP-W</b>	F	1/4 to 3/8					
<b>LAP-W</b>	F	3/8 to 1/2	.90 to 15.9 gpm (3.4 to 60 lpm)				
<b>LBP-W</b>	M	3/8					
<b>S</b> STANDARD ANGLE SPRAY							
<b>SpiralJet Nozzles</b>							
<b>BSJ</b>	M, Hex	1/4 to 4	.49 to 3320 gpm (.20 to 11967 lpm)	400 psi (25 bar)	50° to 180° at 10 psi (.7 bar)	Brass, 316 stainless steel	

FOR DETAILED NOZZLE PERFORMANCE DATA, SEE [spray.com/papercatalog/performance](http://spray.com/papercatalog/performance)



**OVERVIEW: WHIRLJET NOZZLES**

**Ideal for: headboxes, foam knockdown and pollution abatement scrubbers**

- Hollow cone spray pattern with a circular impact area
- Large, unobstructed flow passages minimize clogging
- Good atomization of liquids at lower pressures
- Removable caps for easy inspection and cleaning on some models
- Slope-bottom design models reduce the drilling effect of the fluid vortex in the fluid chamber and premature wear
- AX and BX nozzles form smaller drops
- CX, CRC and D nozzles feature higher flow rates
- AP, LAP and LBP nozzles are constructed of polypropylene and feature excellent corrosion resistance at temperatures up to 160°F (71°C); patented center post design provides extended wear life of the nozzle
- BD and BDM nozzles are in-line versions; liquid passes through a hole on the inlet side of the nozzle
- Standard and wide spray angles

**WhirlJet Nozzles**

As liquid enters the nozzle, it passes into a whirlchamber and begins to spin in a circle at high speed. The rotation forces the liquid away from the center toward the edges of the whirlchamber. This causes the liquid to exit the orifice in a hollow cone pattern. Some WhirlJet nozzles have a slope bottom in the whirlchamber that helps extend wear life.

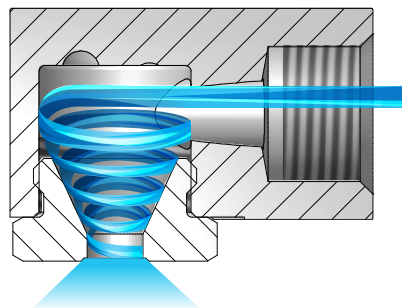

**WHIRLJET AX, AX-W, CX, BX, BX-W, CF, CRC AND D NOZZLES**

- Spray angles: Standard – 43° to 91° , Wide – 112° to 120°
- Uniform spray distribution:
  - AX and BX nozzles – from .05 to 38 gpm (.19 to 145 lpm)
  - CF, CRC, CX and D nozzles – from 2.0 to 2362 gpm (7.3 to 9010 lpm)
  - AX-W and BX-W nozzles – from .05 to 14.2 gpm (.19 to 54 lpm)
- Operating pressures from 3.0 to 100 psi (.2 to 7 bar)

Contact your local sales engineer for information about junction boxes.

S  
W

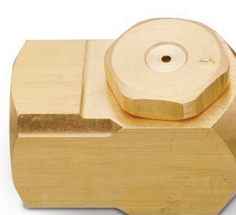

**AX and AX-W**  
Standard angle: 1/8" to 3/4"  
Wide Angle: 1/8" to 1/2"  
female conn.  
Slope-bottom design  
Removable cap

S



**CX**  
1" to 2-1/2" female conn.  
Slope-bottom design  
One-piece cast-type

**WHIRLJET OPTIONS**

S  
W

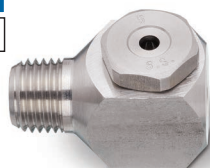

**BX and BX-W**  
Standard angle: 1/8" to 3/4"  
Wide angle: 1/8" to 1/2" male conn.  
Slope-bottom design  
Removable cap

S



**CF**  
4" to 6" flange conn.  
Two-piece cast-type

S



**CRC**  
1-1/4" to 4" female conn.  
Two-piece cast-type

S

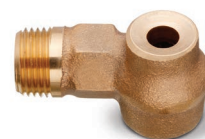

**D**  
1/2" to 3/4" male conn.  
One-piece cast-type



HOLLOW CONE

WHIRLJET® & SPIRALJET® NOZZLES

**S** STANDARD ANGLE SPRAY | **W** WIDE ANGLE SPRAY

**WHIRLJET AP, AP-W, BD, BDM, LAP, LAP-W, LBP AND LBP-W NOZZLES**

- Spray angles: Standard - 43° to 91°, Wide - 112° to 120°
- Uniform spray distribution:
  - AP, LAP and LBP nozzles – from .14 to 18.9 gpm (.20 to 15.9 lpm)
  - AP-W nozzles – from .20 to 5.4 gpm (.75 to 20 lpm)
  - LAP-W and LBP-W nozzles – from .90 to 15.9 gpm (3.4 to 60 lpm)
  - BD nozzles – from .11 to 38 gpm (.41 to 143 lpm)
  - BDM nozzles – from .16 to 9.5 gpm (.61 to 36 lpm), maximum operating pressure 500 psi (34.5 bar)
- Typical operating pressures from 3.0 to 100 psi (.2 to 7.0 bar)

**S**  
**W**



**AP and AP-W**  
1/4" to 3/8" female conn.

WHIRLJET OPTIONS

**S**  
**W**



**BD**  
3/8" to 1-1/2" male conn.  
Removable cap

**S**



**BDM**  
3/8" to 1-1/2" male conn.  
Nylon body

**S**  
**W**



**LAP and LAP-W**  
3/8" to 1/2" female conn.

**S**  
**W**



**LBP and LBP-W**  
3/8" male conn.

OVERVIEW: SPIRALJET

Ideal for: washing, rinsing and cooling

- Hollow cone spray pattern with a circular impact area
- Minimal clogging – maximum flow through passages of any nozzle of comparable size
- Precision impact blade angles distribute drops and provide excellent coverage
- Compact size

Other sizes and materials available. See Industrial Hydraulic Spray Products, Catalog 75A.

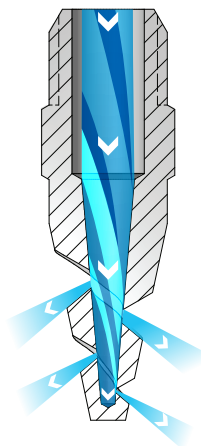

SpiralJet BSJ Nozzles

The liquid entering the nozzle passes through the orifice and exits the voids in the spiral. As it exits, the fluid deflects off the spiral surfaces to form the hollow cone pattern.

SPIRALJET BSJ NOZZLES

- Spray angles: Standard – 50° to 180°
- Uniform spray distribution from .49 to 1126 gpm (2.0 to 4262 lpm)
- Operating pressures up to 400 psi (25 bar)

**S**





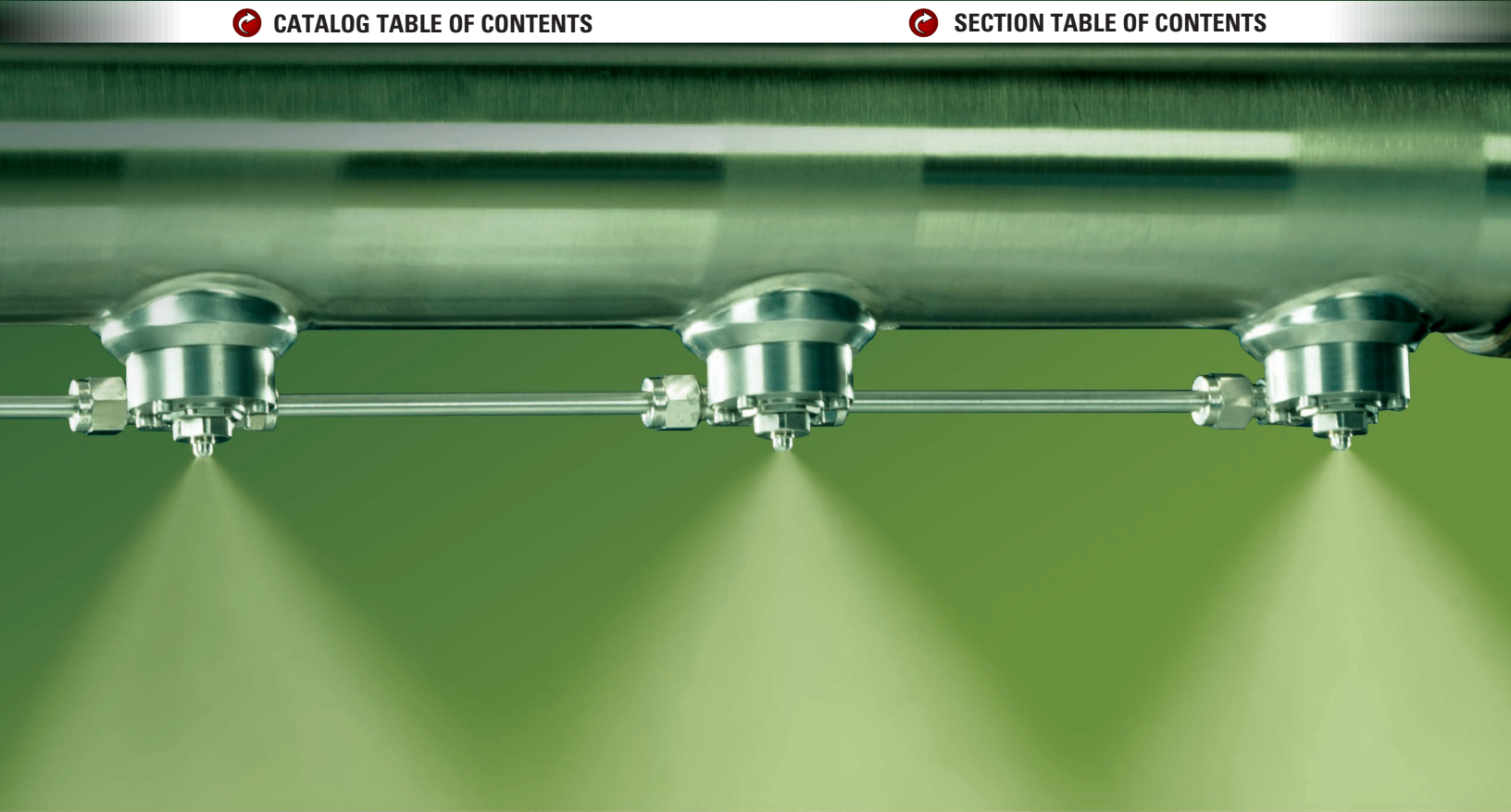



**BSJ** – 1/4" to 2" male conn.  
Threaded/Hex. body style/brass



# AUTOMATIC AND AIR ATOMIZING NOZZLES

## TABLE OF CONTENTS

	PAGE
 Automatic Nozzles Introduction	G2
 Electrically-actuated PulsaJet® Hydraulic Nozzles	G4
 Electrically-actuated PulsaJet Air Atomizing Nozzles	G5
 Air-actuated Air Atomizing Nozzles	G6
 J and JJ Series Air Atomizing Nozzles	G8
 Fogging and Humidification Nozzles	G10
 Other Fogging and Humidification Options	G12



# PRECISE CONTROL & EFFICIENT SPRAY APPLICATION

## INTRODUCTION

If your application requires precise control of intermittent spraying, you'll find many product options in this section. Both electrically-actuated and air-actuated nozzles are available. Models which atomize flow using liquid pressure only or using compressed air are both offered. To optimize the performance of automatic spray nozzles, consider adding an AutoJet® Spray Controller.

## THE BENEFITS OF SPRAY CONTROL

Controlling automatic nozzles with one of our AutoJet spray controllers maximizes nozzle performance and enables automation of spray system operation. Automated spray control can help improve accuracy, reduce waste and overspray, boost production time and allow workers to be deployed to other tasks.

### More specifically, with AutoJet Spray Control you can:

- Adjust flow rate for line or machine speed variations
- Precisely control liquid pressure, atomizing air pressure and fan air pressure to optimize spray performance
- Notify operators or shut down on specified faults
- Integrate control of your spray application with existing plant control

## AUTOJET SPRAY CONTROLLERS

All of our automatic spray nozzles are compatible with our spray controllers. For operations like coating, moisturizing and adding costly chemicals, spray control can dramatically improve product or process quality and help save tens of thousands of dollars annually.



### If your operation requires any of the following, the spray control should be considered.

- Consistent, uniform coverage
- Precise spray placement on the target
- Intermittent spraying
- The use of costly coatings or chemicals
- The ability to adjust spray performance based on line speed
- Monitoring and supervision to ensure proper spray performance

### Our AutoJet Spray Controllers range from basic to advanced.

- **AutoJet Model 1550+ Modular Spray System** with basic on/off spray control for up to eight automatic nozzles
- **AutoJet Model 2008+ Spray Control Panel** provides timing and sensor control for up to 16 nozzles
- **AutoJet Model 2250+ Spray Control Panel** with sophisticated real-time monitoring and closed-loop control for up to 16 nozzles





AUTOMATIC NOZZLES INTRODUCTION

AUTOMATIC & AIR ATOMIZING



PRECISION SPRAY CONTROL (PSC)

PulsaJet® automatic spray nozzles paired with an AutoJet® spray controller provide Precision Spray Control (PSC) to ensure coatings are applied uniformly and with minimal waste.

The benefits of PSC are many:

- Automatically maintains consistent coating weight even when line speed changes
- Reduces product scrap caused by over- or under-application of the sprayed solution
- Reduces the use of costly coatings by applying the proper coating volume directly on the target
- Eliminates maintenance time to clean overspray from equipment and/or floor due to over-application
- Improves worker safety by minimizing misting
- Eliminates the need for compressed air in some operations

HOW PRECISION SPRAY CONTROL WORKS

Electrically-actuated spray nozzles are turned on and off very quickly to control flow rate. This cycling is so fast that the flow often appears to be constant.

With traditional nozzles, flow rate adjustments require a change in pressure. Changing pressure also changes the nozzle's spray angle/coverage and drop size. With PSC, pressure remains constant enabling flow rate changes without changes in spray performance.

NOZZLES SPRAYING 90% OF THE TIME

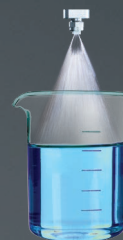
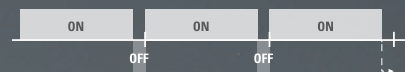

NOZZLES SPRAYING 50% OF THE TIME

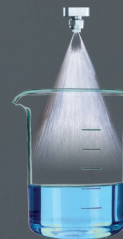
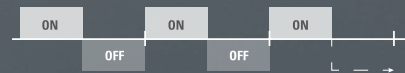

NOZZLES SPRAYING 25% OF THE TIME

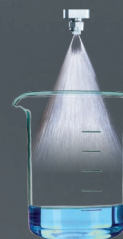

TYPICAL APPLICATIONS:

- Adhesives/glue
- De-ionized water
- Dyes and inks
- Enzymes
- Fragrances/aromas
- Lotions
- Lubricants/release agents/silicone

LEARN MORE & SEE HOW PSC WORKS:  
[spray.com/psc](http://spray.com/psc)

**OVERVIEW: ELECTRICALLY-ACTUATED PULSAJET HYDRAULIC NOZZLES**

- Hydraulic atomizing nozzles use only liquid pressure as the force for atomization
- Electrically-actuated nozzles provide the fastest cycling of any automatic nozzles – up to 25,000 cycles per minute
- When using a PulsaJet® series nozzle and an AutoJet® spray controller, Precision Spray Control (PSC) can provide:
  - Consistent application rates at varying line speeds
  - Low flow rates comparable to air atomizing nozzles eliminating the use of compressed air in some operations
- Dozens of UniJet® spray tips are available for PulsaJet nozzles in a wide variety of flow rates. Auto-alignment of spray tips is offered on some models

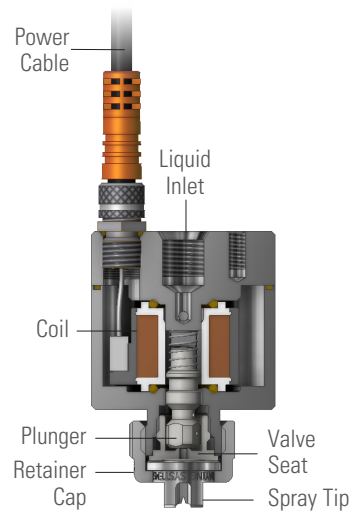

**PulsaJet 10000 Series Nozzle**

The compact design and simple mounting options for PulsaJet nozzles enable them to be easily integrated into most production areas. Wear parts for all PulsaJet nozzles are easily accessible to minimize routine maintenance time.

**ELECTRICALLY-ACTUATED HYDRAULIC PULSAJET NOZZLE OPTIONS**

**AA10000AUH-03**

- Typical flow range: 0.0017 - 0.47 gpm (0.006 - 1.8 lpm)
- Construction: stainless steel, Viton® or EPDM seals, PPS and PEEK

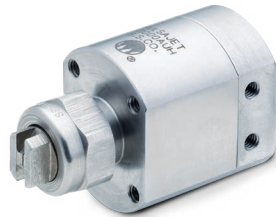

**AA10000AUH-10**

- Typical flow range: 0.02 - 1.6 gpm (0.075 - 6.1 lpm)
- Highest capacity PulsaJet nozzle
- Construction: stainless steel, Viton® or EPDM seals, PPS and PEEK

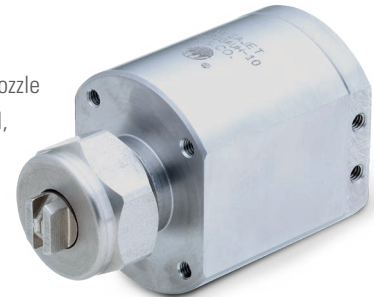

**QUICK REFERENCE GUIDE**

Model/Type	Connection Size/Type in.	Max Liquid Pressure psi (bar)	Power Vdc (Amp)	Max Flow gpm (lpm)	Max Liquid Temp °F (°C)	Max Speed cpm	Spray Tips/ Set-ups
<b>AA10000AUH-03 Hydraulic</b>	1/8	100 (7)* 250 (17) w/ AutoJet® 2008+ spray controller	24 (0.36)	0.47 (1.8)	200 (93)	10,000 (15,000 with AutoJet 2008+ controller)	TPU
<b>AA10000AUH-10 Hydraulic</b>	1/8 F	100 (7)	24 (1.05)	1.6 (6.1)	150 (66)	5,000	TPU

\*Higher pressure possible with AutoJet 2008+ spray controller

ELECTRICALLY-ACTUATED PULSAJET® AIR ATOMIZING NOZZLES

AUTOMATIC & AIR ATOMIZING

**OVERVIEW: ELECTRICALLY-ACTUATED PULSAJET AIR ATOMIZING NOZZLES**

- Electrically-actuated nozzles provide the fastest cycling of any automatic nozzles – up to 10,000 cycles per minute
- Compressed air is used as the force for atomization, producing the smallest drop sizes and lowest possible flow rates
- Hundreds of air atomizing set-ups are available for a wide variety of spray patterns and flow rates
- Precision Spray Control using an AutoJet® Spray Controller ensures consistent flow rates at varying line speeds
- Many options are available for convenient mounting, clean-out needles, food grade materials of construction and more

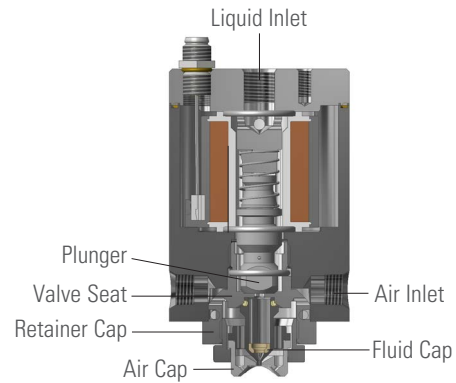

**AA10000JAU Nozzle**

The compact design and simple mounting options for PulsaJet nozzles enable them to be easily integrated into most production areas. Wear parts for all PulsaJet nozzles are easily accessible to minimize routine maintenance time.

**ELECTRICALLY-ACTUATED AIR ATOMIZING PULSAJET NOZZLE OPTIONS**

**AA10000JJAU**

- Rear liquid inlet; side air inlet
- Flow rates up to 0.16 gpm (0.61 lpm)
- Stainless steel, PPS and PEEK construction with Viton® or EPDM seals
- All wear parts accessible from the front of the nozzle without disturbing mounting and air/liquid/electrical connections
- For use with standard 1/8JJ air caps and 1/8JJ fluid caps (maximum size 2850)



**AA10000JAU-10**

- Rear liquid inlet; side air inlet
- Flow rates up to 0.75 gpm (2.84 lpm)
- Stainless steel, PPS and PEEK construction with Viton or EPDM seals
- All wear parts accessible from the front of the nozzle without disturbing mounting and air/liquid/electrical connections
- For use with standard 1/4J air caps and threadless 1/4J fluid caps (maximum size 80100)



**QUICK REFERENCE GUIDE**

Model/Type	Connection Size/Type in.	Max Liquid Pressure psi (bar)	Max Air Pressure psi (bar)	Power Vdc (Amp)	Max Flow gpm (lpm)	Max Liquid Temp °F (°C)	Max Speed cpm	Spray Tips/ Set-ups
<b>AA10000JJAU Air Atomizing</b>	1/8 (air and liquid)	100 (7)* 250 (17) w/AutoJet 2008+ spray controller	100 (7)	24 (0.36)	0.16 (0.61)	200 (93)	10,000	JJ set-ups
<b>AA10000JAU-10 Air Atomizing</b>	1/8 (air and liquid)	100 (7)	100 (7)	24 (1.05)	0.75 (2.84)	200 (93)	5,000	Threadless 1/4J set-ups

\*Higher pressure possible with AutoJet 2008+ spray controller

FOR DETAILED NOZZLE PERFORMANCE DATA, SEE AIR ATOMIZING & AUTOMATIC SPRAY NOZZLES, CAT 76

**OVERVIEW: AIR-ACTUATED  
AIR ATOMIZING NOZZLES**

**Ideal for: coating, moisturizing and marking**

- Compressed air is used to control air cylinder operation for accurate intermittent spraying (up to 180 cycles per minute) and also for liquid atomization
- Wide variety of nozzle bodies is available for convenient mounting and positioning
- Models available with clean-out needles, shut-off needles, swivels and strainers to optimize performance
- Liquid lines can be pressure-fed, siphon-fed or gravity-fed
- Spray set-ups, consisting of an air cap and a fluid cap can mix the fluids either internally or externally to produce a fine spray pattern
- Dozens of Drip Free™ air atomizing spray set-ups available for a wide range of flow capacity and spray patterns

**For a wide range of options, such as clean-out needles, body styles and spray tips, see Automatic and Air Atomizing Spray Nozzles, Cat. 76.**

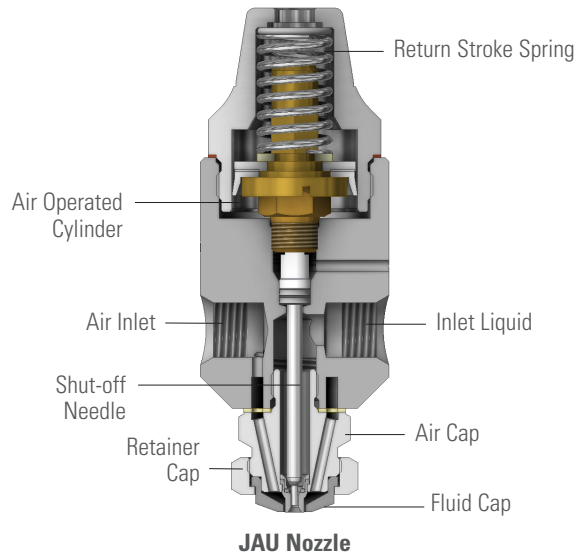

**JAU Nozzle**  
JAU air atomizing nozzles mix compressed air and liquid to form a finely atomized spray. An air-actuated internal cylinder with return stroke spring cycles the nozzle up to 180 times per minute.

**AIR-ACTUATED AIR ATOMIZING NOZZLE OPTIONS**

**1/4JAU**

- Flow rates up to 1.2 gpm (4.5 lpm)
- Drip Free™ set-ups provide complete shut-off
- Nickel-plated brass or stainless steel construction



**1/8JJAU**

- Compact design ideal where space is limited
- Flow rates up to 0.55 gpm (2.1 lpm)
- Drip Free™ set-ups provide complete shut-off
- Nickel-plated brass or stainless steel construction



FOR DETAILED NOZZLE PERFORMANCE DATA,  
SEE AIR ATOMIZING & AUTOMATIC  
SPRAY NOZZLES, CAT 76

AIR-ACTUATED AIR ATOMIZING NOZZLES

AUTOMATIC & AIR ATOMIZING

AIR-ACTUATED AIR ATOMIZING NOZZLE OPTIONS

**VAU/VMAU Variable Spray**

- Flow rates up to 1.22 gpm (4.62 lpm)
- Stainless steel construction
- Independent control of liquid, fan air and atomizing air provides maximum control of spray coverage
- Dual liquid inlets allow recirculating of sprayed fluid
- VMAU offers modular construction for reduced maintenance time



**10535-1/4J**

- Flow rates up to 1.2 gpm (4.5 lpm)
- Self-contained air cylinder provides controlled intermittent spraying
- Drip Free™ set-ups provide complete shut-off
- Nickel-plated brass or stainless steel construction
- Also available in ½" and 1" sizes



QUICK REFERENCE GUIDE

Model	Connection Size in.	Max Liquid Pressure psi (bar)	Max Air Cylinder Pressure psi (bar)	Max Flow gpm (lpm)	Max Liquid Temp °F (°C)	Max Speed cpm	Spray Set-ups
<b>1/4JAU</b>	1/4 (air and liquid)	125 (8.6)	30 (2.1)	1.2 (4.5)	400 (204)	180	1/4J
<b>1/8JJAU</b>	1/4 (air and liquid)	125 (8.6)	30 (2.1)	0.55 (2.1)	400 (204)	180	1/8JJ
<b>1/8VAU Air Atomizing</b>	Variable Spray	90 (6.2)	35 (2.4)	0.83 (3.15)	200 (93)	180	SUV
<b>1/4VMAU Air Atomizing</b>	1/4, or sanitary flange (atom. air, fan air and liquid)	90 (6.2)	35 (2.4)	1.22 (4.62)	200 (93)	180	SUVM
<b>10535-1/4J Air Atomizing</b>	1/4 (air and liquid)	125 (8.6)	30 (2.1)	1.2 (4.5)	400 (204) liquid 150 (66) air	180	1/4J

FOR DETAILED NOZZLE PERFORMANCE DATA, SEE AIR ATOMIZING & AUTOMATIC SPRAY NOZZLES, CAT 76



**OVERVIEW: J AND JJ SERIES AIR ATOMIZING NOZZLES**

**Ideal for: coating, moisturizing and marking**

- Liquid and compressed air enter the nozzle body and are mixed by the spray set-up to produce a finely atomized spray pattern
- Spray set-ups, consisting of an air cap and a fluid cap, can mix the fluids either internally or externally
- Hundreds of spray set-ups are available to produce cone and flat spray patterns
- A wide variety of nozzle bodies are available for convenient mounting and positioning
- JJ compact nozzle bodies are available for applications where space is limited
- Models available with clean-out needles, shut-off needles swivels and strainers to optimize performance

**For a wide range of options, such as clean-out needles, body styles and spray tips, see Automatic and Air Atomizing Spray Nozzles, Cat. 76.**

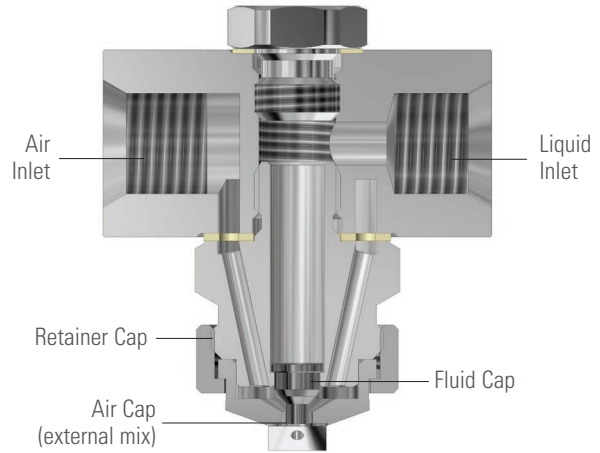

**1/4J Nozzle**

Air and liquid enter the air atomizing nozzle body and are combined by the spray set-up to generate finely atomized droplets.

**1/8J AND 1/4J SERIES NOZZLES**

- J Series nozzles consist of a nozzle body and a spray set-up
- A wide variety of spray set-ups are available with flow rates up to 72 gph (273 lph) in various spray patterns.
- Basic 1/8J and 1/4J bodies have liquid and air inlets on opposing sides of the nozzle bodies. Nozzle bodies include a removable plug so needle assemblies can be added in the future
- Nickel-plated brass or stainless steel construction

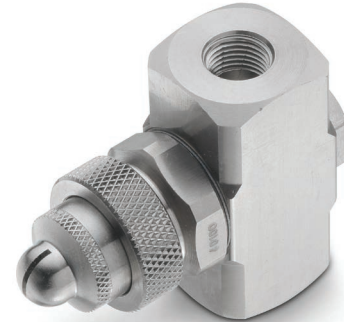

**1/8J and 1/4J Nozzles**

**1/8J AND 1/4J NOZZLE OPTIONS**

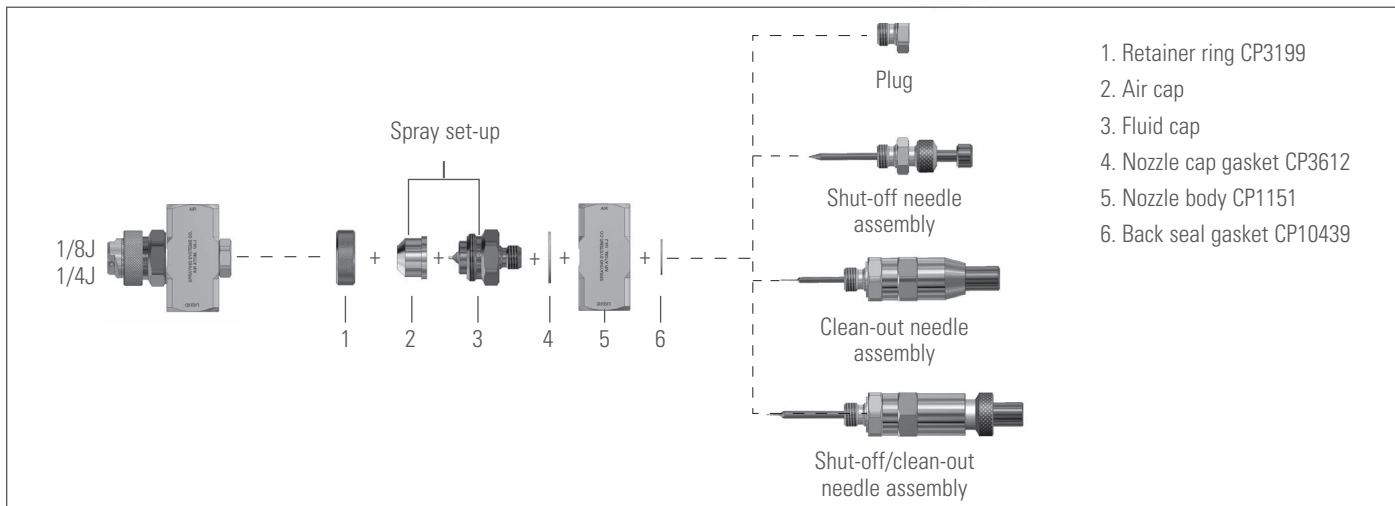

J AND JJ SERIES AIR ATOMIZING NOZZLES

AUTOMATIC & AIR ATOMIZING

1/8JJ SERIES NOZZLES

- Compact JJ Series nozzles consist of a nozzle body and a spray set-up
- A wide variety of spray set-ups are available with flow rates up to 33 gph (126 lph) in various spray patterns
- 1/8JJ bodies have liquid and air inlets on opposing sides of the nozzle bodies. Nozzle bodies include a removable plug so needle assemblies can be added in the future
- Nickel-plated brass or stainless steel construction



1/8JJ Nozzle

JJ SERIES SPRAY NOZZLE OPTIONS

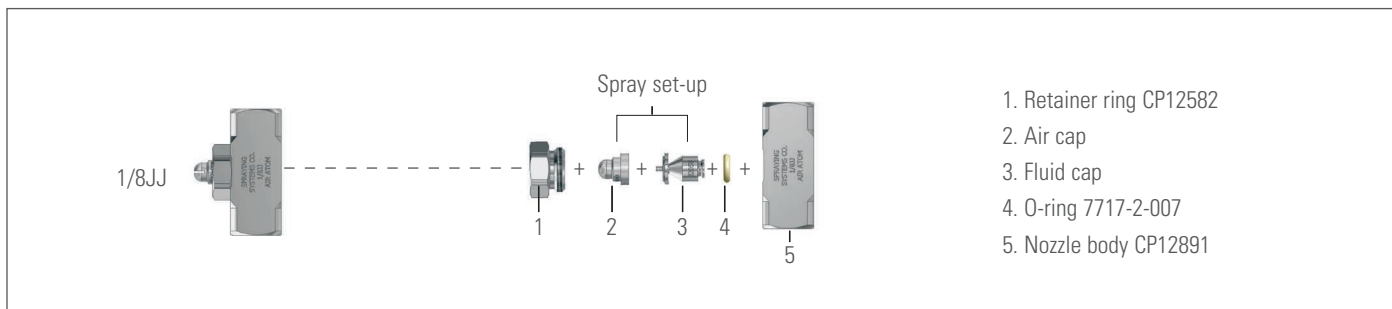

QUICK REFERENCE GUIDE

Model	Connection Size in.	Max Flow gph (lph)	Max Liquid Temp °F (°C)	Spray Set-ups
1/8J and 1/4J	1/8 to 1/4	72 (273)	400 (204)	1/8J and 1/4J
1/8JJ	1/8	33.2 (126)	400 (204)	1/8JJ

FOR DETAILED NOZZLE PERFORMANCE DATA, SEE AIR ATOMIZING & AUTOMATIC SPRAY NOZZLES, CAT 76



**OVERVIEW: FOGGING & HUMIDIFICATION**

- Liquid and compressed air are mixed to produce a finely atomized spray for rapid evaporation and efficient humidification
- Drop size may be controlled by adjusting air and water pressure to create a wet or a dry fog, depending on application requirements
- Several configurations are available to produce flow rates up to 72 gph (272 lph)
- Nozzles are available that operate using normal municipal water pressure – without the use of high-pressure pumps
- A variety of nozzle bodies are available for convenient mounting and positioning

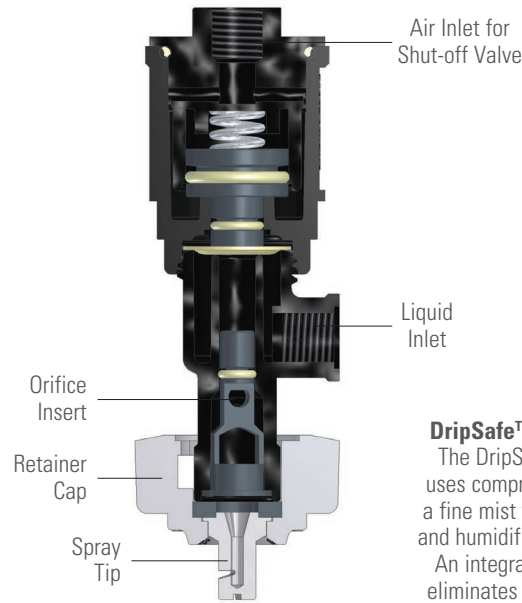

**DripSafe™ AirJet® Fogger**  
The DripSafe AirJet Fogger uses compressed air to create a fine mist for fogging, cooling and humidification applications. An integrated shut-off valve eliminates unwanted dripping from the nozzle.

**DRIPSAFE™ AIRJET® FOGGER NOZZLES**

- High quality, cost-efficient dry fog with average drop size of fifteen microns or less
- Drop size can be adjusted by changing the ratio of compressed air to water
- High-volume/high-efficiency air atomization is ideal for large/open structures and areas with high air exchange rates
- DripSafe air-actuated shut-off valve prevents liquid flow until air pressure at the nozzle is sufficient for fine atomization
- Flat spray tip has a large orifice that reduces clogging
- Spray set-up and built-in strainer are quickly removed by hand if cleaning is required
- Can use PVC pipe and low-pressure air tubing
- Operates using normal pressures found in municipal water systems, eliminates the need for expensive, high-pressure hydraulic pumps
- Spray tip is brass; valve and body are polymer
- Minimum air pressure range of 25 to 35 psi (1.7 to 2.5 bar)



**45265 AirJet Fogger –**  
Threaded 1/4" NPT or BSPT connection

**45269 AirJet Fogger –**  
Split-eyelet design provides fast installation of the nozzle onto the liquid supply pipe. No additional pipe fittings are required. Pipe cutting, threading and brazing are eliminated.



FOGGING AND HUMIDIFICATION NOZZLES

AUTOMATIC & AIR ATOMIZING

**YMF MINIFOGGER® III**

- High quality, cost-efficient dry fog with drop sizes seven to ten microns
- Compact design of 4.5" (115 mm) tall ideal for humidification applications with limited space
- Can be easily installed on a header, wall or ceiling
- Available with up to four stainless steel spray nozzle set-ups, each with automatic spray pattern alignment
- Choice of spray set-ups provide flow rates ranging from 0.24 to 1.22 gph (0.9 to 4.6 l/hr)
- 0.46 lbs. (210 g) for single spray set-up type; 0.55 lbs. (250 g) for multiple four set-up types
- Body, retainer cap and tank constructed of corrosion-resistant polypropylene with stainless steel air and water inlet connections
- Materials compatible with deionized water
- Easy to maintain – no tools required



**QUICK REFERENCE GUIDE**

Product Number	Connection Type	Max Flow
<b>45265 DripSafe™ AirJet® Fogger</b>	.290" (7.4 mm) hose shank for 1/4" air hose or tubing (atomizing air) 1/4" (shut-off valve air) 1/4" (liquid)	4.5 gph (17.0 lph)
<b>45269 DripSafe AirJet Fogger</b>	.290" (7.4 mm) hose shank for 1/4" air hose or tubing (atomizing air) 1/4" (shut-off valve air) Split-eyelet connection for 1/2", 3/4" or 1" liquid supply pipe	4.5 gph (17.0 lph)
<b>YMF MiniFogger III</b>	1/4" (air) 1/8" (liquid)	1.22 gpm (4.6 lpm)
<b>1/4JH</b>	1/4" (air and liquid)	72 gph (272 lph)
<b>1/4JT</b>	1/4" (air and liquid)	11.6 gph (43.9 lph)

FOR DETAILED NOZZLE PERFORMANCE DATA,  
SEE AIR ATOMIZING & AUTOMATIC  
SPRAY NOZZLES, CAT 76



**OTHER FOGGING AND HUMIDIFICATION OPTIONS**

**1/4JH Nozzle**

- Provides automatic, efficient humidity control with low installation and operating costs
- Produces a fine atomized spray for rapid evaporation and efficient humidification
- Nozzles operate either with compressed air drawing water from the float box, by siphon action, or with water delivered to the nozzle under pressure



**1/4JT Nozzle**

- Provides automatic, efficient humidity control with low installation and operating costs
- Produces a fine atomized spray for rapid evaporation and efficient humidification
- Suitable for use in systems where water is under pressure
- Built-in strainer for air and water plus a ball check valve in the water line



**45400 Humidification Unit**

- A self-contained humidifier suitable for use with deionized water
- Easy to install on a wall or for use in non-ducted applications
- Air regulator and gauge, 24VDC air control solenoid and air line filter are included
- Wall-mounting bracket is also provided
- For each spray set-up, water capacity ranges from 2.7 lbs/hr at 10 psi (0.7 bar) air to 6.5 lbs/hr at 60 psi (4 bar) air
- 9.7 lbs. (4.4 kg)



**55089 Humidistat**

- Quick relative humidity LCD readouts from 1% to 99% with repeatability of +/-5%
- Operating temperature range 32°F to 160°F (0°C to 71°C)
- 24V (DC or AC)



FOR DETAILED PERFORMANCE DATA,  
SEE AUTOMATIC AND AIR ATOMIZING  
SPRAY NOZZLES, CAT. 76



# CHEST CLEANERS

## TABLE OF CONTENTS

	PAGE
 TankJet® Tank and Chest Cleaners	H2
 Strainers	H8



**OVERVIEW: TANKJET TANK AND CHEST CLEANERS**

**Ideal for: pulp chests, headboxes, broke storage chests, tile-lined stock chests, machine chests, low-D chests, HY-D chests, small vessels, totes and more**

- Consistent, thorough cleaning of tanks and chests using less water and chemicals than manual or fill and drain methods
  - Eliminates the need to use costly contract cleaning services or having workers enter large chests
  - Choose from high-impact, motor- or fluid-driven machines; constant or variable speed rotating units; and stationary spray nozzle and spray balls
  - Wide range of operating pressures, spray coverages, connections, materials, nozzle hubs and more
  - Units available for cleaning chests and tanks up to 100 ft. (3.5 m) in dia.
- Some of the most commonly used products in mills are featured here. For complete specifications and performance data, see TankJet Tank Cleaning Products, Cat. 75TJ.**

**TANKJET TANK AND CHEST CLEANER OPTIONS**

**TankJet 360**

**For high-impact chest cleaning or tanks up to 100 ft. (30.5 m) in diameter**

- Provides consistent, high-impact, high-efficiency cleaning over the entire pressure range for short cycle times
- Can be used for high-concentration chemical recirculation cleaning or low pressure, high-volume cleaning
- Nozzles rotate 360° in horizontal and vertical planes, creating a crisscrossing pattern to thoroughly clean tanks and remove the stickiest of residues
- Standard clutch version permits easy nozzle hub rotation by hand for insertion and removal from tank; optional pin version for permanent or CIP installations; optional external, self-rinsing nozzles are available for both pin and clutch versions
- Built-in strainer minimizes clogging and extends wear life; user-serviceable for easy maintenance



**TankJet AA290**

**For high-impact chest cleaning or tanks up to 100 ft. (30.5 m) in diameter**

- Dependable, durable motor-driven units provide consistent, high-impact, 360° cleaning to remove the most stubborn residues
- Construction features corrosion-resistant 316 stainless steel with PTFE fluoropolymer resin seals; having the motor positioned outside the tank ensures longer life and fewer failures due to exposure to harmful cleaning solutions
- 55430 series solid stream nozzles provide optimum impact and have removable stabilizer vanes for easy maintenance
- Choice of:
  - CE-rated air (AG) or explosion-proof (E-EP) electric motor
  - Two- or four-nozzle hub
  - Extension lengths from 3 ft. (0.9 m) up to 10 ft. (3.0 m)



TANKJET® TANK AND CHEST CLEANERS

CHEST CLEANERS

**TankJet 78**

**For high-impact chest cleaning or tanks up to 45 ft. (13.7 m) in diameter**

- High-impact, 360° cleaning ensures tank cleanliness and results in shorter cleaning cycles and reduced use of water and chemicals
- Fast and easy maintenance without tools
- Easy retrofit for spray balls
- Choice of two- or four-nozzle configurations and inlet connection size



**TankJet AA190**

**For high-impact chest cleaning or tanks up to 40 ft. (12.2 m) in diameter**

- Versatile, high-impact tank cleaner provides efficient, consistent, reliable cleaning with virtually no maintenance
- Lightweight units can be installed permanently or easily moved from tank to tank
- Component and configuration options allow easy customization to meet the needs a variety of cleaning operations. Choice of:
  - Variable speed, CE-approved air (AG), electric (E) or explosion-proof (E-EP) electric motors
  - Operational pressure range from 100 up to 1000 psi (7 to 69 bar)
  - 360° or 180° coverage
  - Extension lengths from 4 in. (1.2 m) to 10 ft. (3.0 m)

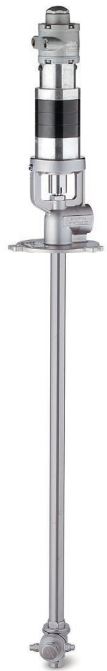

**TankJet 27500**

**For chests up to 25 ft. (7.6 m) in diameter**

- Excellent cleaning and rinsing; reactionary force of cleaning liquid drives rotation of nozzles
- Spray angles range from 180° to 360° and can be used to clean specific areas or the entire tank interior
- Made of corrosion- and chemical-resistant PTFE fluoropolymer resin
- Delivers greater impact than static spray balls



**TankJet 6353**









**For rinsing chests up to 10 ft. (3.0 m) in diameter**

- Simple and reliable with no moving parts
- Individual nozzles (13 total) can be replaced with plugs to provide specific cleaning coverages
- Nozzles are easily removed for cleaning and inspection
- Can be installed in any position



FOR DETAILED NOZZLE PERFORMANCE DATA, SEE TANKJET® TANK CLEANING PRODUCTS, CAT. 75TJ









QUICK REFERENCE GUIDE

Nozzle	Max. Tank Dia. ft. (m)	Operating Principle	Flow Rate gpm (lpm)	Operating Pressure psi (bar)	Spray Coverage	Min. Tank Opening in. (mm)	Max. Temp. °F (°C)	Typical Applications
<b>TankJet 360</b> 	<b>100</b> (30.5)	Fluid-driven turbine	30 to 300 (114 to 1136)	40 to 350 (2.8 to 24.1)	360°	6.25 (159) for 2 nozzle; 10.25 (260) for 3 nozzle	250 (121)	Cleaning large stock chests and tanks in the mill
<b>TankJet AA290</b> 		Motor-driven	24 to 284 (91 to 1075)	50 to 250 (3.4 to 17.2)	360°	7.25 (184) for 2 nozzle; 8.25 (210) for 4 nozzle	200 (93)	Cleaning large stock chests and tanks with stubborn residues
<b>TankJet 180</b> 	<b>80</b> (24.4)	Fluid-driven turbine	30 to 300 (114 to 1136)	40 to 350 (2.8 to 24)	180°	12.25 (311)	250 (121)	Cleaning large open top stock chests and vessels
<b>TankJet 80</b> 	<b>50</b> (15.2)	Fluid-driven turbine	53 to 142 (200 to 538)	60 to 200 (4.1 to 13.8)	360°	6.5 (165) for 2 nozzle; 12.5 (318) for 3 nozzle	250 (121)	Cleaning large stock chests and tanks with stock buildup
<b>TankJet 78 &amp; 78D</b> 	<b>45</b> (13.7)	Fluid-driven turbine	65 to 165 (246 to 625)	25 to 100 (1.7 to 6.9)	360°	TJ78: 5.75 (146) TJ78D: 7.63 (194)	200 (93)	Rinsing medium-size vessels which require more sanitary designs
<b>TankJet 65 &amp; 65HT</b> 	<b>40</b> (12.2)	Fluid-driven turbine	30 to 150 (114 to 568)	50 to 150 (3.4 to 10.3)	360°	7.5 (190)	TJ65: 250 (121) TJ65HT: 500 (260)	Quick cleaning of large tanks
<b>TankJet AA190</b> 		Motor-driven	3.1 to 44 (11.8 to 167)	100 to 1000 (6.9 to 69)	180°, 360°	3.75 (95) for 360°; 4.5 (114.3) for 180°	200 (93)	Cleaning different size tanks with varying residues
<b>TankJet YMD3</b> 	<b>30</b> (9.1)	Motor-driven	8.6 to 37.5 (32.6 to 142)	725 to 4350 (50 to 300)	360°	3.75 (95)	176 (80)	High-pressure cleaning









TANKJET® TANK AND CHEST CLEANERS

CHEST CLEANERS

QUICK REFERENCE GUIDE

Nozzle	Max. Tank Dia. ft. (m)	Operating Principle	Flow Rate gpm (lpm)	Operating Pressure psi (bar)	Spray Coverage	Min. Tank Opening in. (mm)	Max. Temp. °F (°C)	Typical Applications
 <p><b>TankJet 75</b></p>	<b>30 (9.1)</b>	Fluid-driven turbine	15.0 to 33 (57 to 125)	75 to 300 (5.2 to 21)	360°	3.75 (95)	250 (121)	Quick cleaning of large tanks
 <p><b>TankJet 27500 &amp; 27500-R</b></p>	<b>10 to 25 (3.0 to 7.6)</b>	Fluid-driven reactionary force	4.0 to 224 (15.3 to 850)	10.0 to 50 (0.7 to 3.4)	180° up/down, 270° up/down, 360°	2 to 7 (51 to 178)	200 (93)	Cleaning with corrosive chemicals or in corrosive environment
 <p><b>TankJet 16</b></p>	<b>24 (7.2)</b>	Fluid-driven turbine	36 to 76 (136 to 288)	50 to 200 (3.4 to 13.8)	180° up/down, 270° down, 360°	3 (76)	250 (121)	Cleaning medium-size vessels with small openings
 <p><b>TankJet 28500 &amp; 28500-R</b></p>	<b>18 (5.5)</b>	Fluid-driven reactionary force	9.0 to 78.3 (34 to 296)	10.0 to 50 (0.7 to 3.4)	180° up/down, 270° up/down, 360°	2.5 to 4 (64 to 102)	200 (93)	Rinsing medium-size vessels which require more sanitary designs
 <p><b>TankJet 12900</b></p>	<b>18 (5.5)</b>	Fixed stationary	72 to 385 (280 to 1470)	20 to 50 (1.4 to 3.4)	360° and custom spray angles	10 (254)	212 (100)	Rinsing medium headboxes or machine washdown
 <p><b>TankJet AA090</b></p>	<b>16 (4.9)</b>	Motor-driven	1.5 to 7.3 (5.7 to 28)	100 to 500 (6.9 to 34.5)	360°	2.3 (59)	200 (93)	High-impact cleaning of medium-size chests
 <p><b>TankJet D26984 &amp; D40159</b></p>	<b>10 to 16 (3.0 to 4.9)</b>	Fluid-driven constant speed	3.2 to 19.8 (12.0 to 75)	30 to 90 (2.1 to 6.2)	65° down, 120° down, 180° up/down, 260° up/down, 360°	Thread: 2.25 (56) CIP version: 4 (102)	160 (70)	Cleaning and rinsing of medium-size vessels requiring different spray coverages
 <p><b>TankJet D41800E</b></p>	<b>10 to 16 (3.0 to 4.9)</b>	Fluid-driven constant speed	3.0 to 22.8 (11.0 to 86)	30 to 90 (2.1 to 6.2)	360°	1.25 (32)	265 (130)	Cleaning medium-size vessels requiring sanitary type designs

QUICK REFERENCE GUIDE





Nozzle	Max. Tank Dia. ft. (m)	Operating Principle	Flow Rate gpm (lpm)	Operating Pressure psi (bar)	Spray Coverage	Min. Tank Opening in. (mm)	Max. Temp. °F (°C)	Typical Applications
<b>TankJet D41990</b> 	<b>6.5 to 16</b> <b>(2.0 to 4.9)</b>	Fluid-driven reactionary force	2.4 to 37.4 (9.0 to 141)	15.0 to 60 (1.0 to 4.1)	180° up/down, 360°	Thread: 1 to 1.5 (25 to 38) CIP version: 2 to 4 (51 to 102)	265 (130)	Cleaning small to medium chests in high-risk environments
<b>TankJet 9 A, B &amp; C</b> 	<b>6 to 16</b> <b>(1.8 to 4.9)</b>	Fluid-driven reactionary force	1.3 to 38 (4.9 to 144)	10.0 to 120 (0.7 to 8.3)	2 x 175°, 360°	TJ9-A: 1.25 (32) TJ9-B: 1.5 (38) TJ9-C: 1.75 (44)	190 (88)	Cleaning small to medium chests with very small tank openings
<b>TankJet 63225</b> 	<b>13</b> <b>(4.0)</b>	Fixed stationary	22 to 51 (83 to 192)	15.0 to 40 (1.0 to 2.8)	360°	1.5 to 4 (38 to 102)	400 (204)	Rinsing medium-size vessels which require sanitary-type designs
<b>TankJet 14 &amp; 19</b> 	<b>12</b> <b>(3.7)</b>	Fluid-driven turbine	10.0 to 30 (38 to 114)	50 to 200 (3.4 to 13.8)	180° up/down, 270° down, 360°	2 (51)	250 (121)	Rinsing medium-size chests with medium impact
<b>TankJet 6353 &amp; 6353-MFP</b> 	<b>10</b> <b>(3.0)</b>	Fixed stationary	8.9 to 80 (35 to 301)	20 to 50 (1.4 to 3.4)	360°	6 (152)	212 (100)	Rinsing smaller tanks or headboxes
<b>TankJet 18250A</b> 	<b>8</b> <b>(2.4)</b>	Fluid-driven reactionary force	10.5 to 55 (48 to 205)	10.0 to 60 (0.7 to 4.1)	360°	2.38 (60)	350 (177)	Cleaning small vessels
<b>TankJet D41892</b> 	<b>6.5</b> <b>(2.0)</b>	Fluid-driven reactionary force	4.0 to 7.5 (15.9 to 29)	20 to 70 (1.4 to 4.8)	360°	1.5 (37)	160 (70)	Cleaning small tanks in high-risk environments
<b>TankJet M60</b> 	<b>5</b> <b>(1.5)</b>	Motor-driven	1.1 to 10.1 (4.2 to 38)	100 to 1000 (6.9 to 69)	360°	1.75 (44.5)	180 (82)	Mobile cleaning of multiple totes and open-bottom vessels
<b>TankJet D26564</b> 		Fluid-driven reactionary force	2.4 to 5.4 (9.0 to 20.5)	14.5 to 72.5 (1.0 to 5.0)	180° up/down	1.5 (37)	194 (90)	Rinsing open top totes or small vessels



TANKJET® TANK AND CHEST CLEANERS

CHEST CLEANERS

QUICK REFERENCE GUIDE

Nozzle	Max. Tank Dia. ft. (m)	Operating Principle	Flow Rate gpm (lpm)	Operating Pressure psi (bar)	Spray Coverage	Min. Tank Opening in. (mm)	Max. Temp. °F (°C)	Typical Applications
<b>TankJet 21400A</b> 	<b>5 (1.5)</b>	Fluid-driven reactionary force	5.0 to 22 (23 to 82)	10.0 to 60 (0.7 to 4.1)	360°	2.25 (60)	350 (177)	Rinsing totes or small vessels
<b>TankJet VSM</b> 		Fixed stationary	2.7 to 72 (10.4 to 269)	10.0 to 150 (0.7 to 10.3)	240° down	2 (51)	200 (93)	Rinsing or foam control in small tanks
<b>TankJet 30473</b> 	<b>3 (0.9)</b>	Fluid-driven reactionary force	2.1 to 4.5 (7.8 to 18.0)	10.0 to 50 (0.7 to 3.4)	180° up/down, 360°	1 (25)	200 (93)	Cleaning or foam control in small tanks with small openings
<b>TankJet 23240-2</b> <b>23240-3</b> 		Fluid-driven reactionary force	3.5 to 22 (14.0 to 79)	20 to 200 (1.4 to 13.8)	360°, side spray	1.03 (26)	350 (177)	Cleaning small headboxes, ducts or vessels

MESH RECOMMENDATIONS

Nozzle Type	Mesh Recommendation
Motor Driven Tank Cleaner	100 min.
Fluid Driven (Turbine)	30 to 50
Fluid Driven (Reactionary Force and Constant Speed)	200 min.
Fixed Stationary	Refer to Mesh to Micron Conversion Chart

MESH TO MICRON CONVERSION CHART

Mesh	Micron	Inches (mm)
16	1191	0.0469 (1.2)
20	840	0.0331 (.84)
30	590	0.0232 (.58)
50	297	0.0117 (.29)
60	250	0.0098 (.24)
80	177	0.0070 (.17)
100	149	0.0059 (.14)
200	74	0.0035 (.08)

FOR DETAILED NOZZLE PERFORMANCE DATA, SEE TANKJET® TANK CLEANING PRODUCTS, CAT. 75TJ



**OVERVIEW: STRAINERS**

- Reduce clogging in tank cleaners and tank cleaning nozzles
- Remove contaminants from liquid to ensure continuous movement of rotating spray heads
- Extend wear life of nozzles, valves and pumps
- Wide range of options: heavy duty, heavy duty high pressure, self cleaning and a wide range of mesh sizes

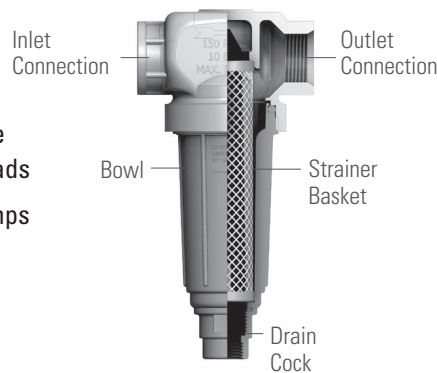

**T-Style Strainer**

T-strainers feature a removable bottom cap or plug for complete withdrawal of the screen assembly during cleaning. On some models, the bottom pipe plug can be replaced with a drain cock for quick-flush cleaning. Models with a clear nylon bowl allow easy visual inspection of the internal screen. Self-clean designs allow filtered liquid to pass through, while liquid particles are returned back to the liquid supply through a return outlet.

**STRAINER OPTIONS**

**TWD**

- 1/4", 3/8", 1/2", 3/4", 1", 1-1/4", 1-1/2", 2", 2-1/2" female conn.
- Removable bottom plug for easy screen cleaning
- Bottom plug can be replaced with drain cock for flush cleaning
- Use TWC for connections of 3" and up.
- TWC handles large flow rates with minimal pressure drops. Call your local specialist for application assistance.
- Materials: Aluminum, brass, stainless steel
- Mesh: 16, 30, 50, 80, 100, 40 x 200 Dutch weave
- Max. pressure: 300 psi (20 bar)



**8310A**

- 1/4", 3/8", 1/2" female connection
- Designed for high pressure operation
- Removable bottom plug for easy flush cleaning of screen
- Material: Stainless steel
- Mesh: 16, 30, 50, 100
- Max. pressure: 5000 psi at 150°F (345 bar at 66°C)



**AA124/AA430**

- 3/4", 1", 1-1/4", 1-1/2", 2", 2-1/2" female connection (Inlet connections vary depending on strainer type)
- Larger size screen area requires less frequent cleaning
- Self-cleaning styles and versions with mounting lugs available
- AA124 and AA430 versions are the same except for materials and inlet connections



Strainer Type	Strainer Part No.	Material*	Max. Pressure	Mesh Sizes
124	AA124-AL	Aluminum head/nylon bowl	150 psi (10 bar)	16, 30, 50, 80, 100
124ML with mounting holes**	AA124ML-AL	Aluminum head/nylon bowl	150 psi (10 bar)	16, 30, 50, 80, 100
124A self-cleaning version	AA124ASC-NYB	Aluminum head/nylon bowl	110 psi (8 bar)	16, 30, 50, 80, 100
430ML with mounting holes**	AA430ML	Polypropylene head/nylon bowl	110 psi (8 bar)	16, 30, 50, 80, 100, 120, 200†
430 self-cleaning version	AA430SC	Polypropylene head/nylon bowl	75 psi (5 bar)	16, 30, 50, 80, 100, 120, 200†

\*Max. temperature for plastic 100°F (38°C); max. temperature for metal 180°F (82°C).  
 \*\*For mounting on machinery or angle iron.  
 †120 only for 1-1/4" and 1-1/2" sizes; 200 only for 3/4" and 1" sizes.

**QUICK REFERENCE GUIDE**

Model	Connection Type	Connection Size in.	Material
<b>TWD</b>	Female	1/4, 3/8, 1/2, 3/4, 1, 1-1/4, 1-1/2, 2, 2-1/2	Aluminum, brass, stainless steel
<b>8310A</b>	Female	1/4, 3/8, 1/2	Stainless steel
<b>AA124/AA430</b>	Female	3/4, 1, 1-1/4, 1-1/2, 2, 2-1/2	Aluminum head/nylon bowl or Polypropylene head/nylon bowl



# AIR KNIFE PACKAGES AND AIR NOZZLES

## TABLE OF CONTENTS

	PAGE
<b>BLOWER AIR PRODUCTS</b>	
 WindJet® Air Knife and Regenerative Blower Packages	13
 WindJet Air Cannons	13
 Accessories	14
<b>WINDJET COMPRESSED AIR NOZZLES</b>	
 WindJet Nozzles	15
 WindJet Low Flow Air Knives	15
 WindJet Variable Air Amplifiers	15
 UniJet® Nozzles	16



**OVERVIEW: WINDJET AIR KNIFE PACKAGES AND COMPRESSED AIR PRODUCTS**

Ideal for: sheet control, dust blow-down, CIP air control system, drying and sheet cooling

**WindJet Air Knife Packages**

- Powered by regenerative blowers and eliminate the need for costly compressed air
- Regenerative blower performance advantages over other blower types:
  - Lower noise
  - Lower maintenance
  - Longer life
  - Lower operating costs
  - Warm air can improve drying
  - Fully customized solution
- Packages include air knives that produce a uniform, high volume, constant air stream along the entire knife length
- Air cannons providing high velocity air directed into holes and crevices for complete drying or blow-off are also available
- Air knife packages are commonly used when extremely clean air is required (HEPA filtration an option), no existing air source is available or energy reduction is desirable

**WindJet Compressed Air Nozzles**

- Convert low-pressure volumes of air into a targeted, high-velocity stream or flat fan air pattern and provide many benefits, including:
  - Improve drying or blow-off by increasing impact on the target
  - Use 25% to 35% less air compared to open holes or slits in pipes
  - Reduce perceived noise by 28% to 60% compared open pipe



FOR DETAILED PERFORMANCE DATA, SEE  
WINDJET® AIR PRODUCTS, CAT. 20

**BLOWER AIR PRODUCT OPTIONS**

**WindJet® Air Knives**

- Superior performance – straight, controlled air stream
- Standard knife lengths of 6", 12", 18", 24", 30" and 36" (152, 305, 457, 610, 762 and 914 mm)
- Custom lengths available
- Dual inlet knives available (suggested for lengths greater than 60" [1524 mm] )
- Air slot sizes of .040" and .060" (1 and 1.5 mm)
- Leak-proof end cap gaskets to prevent leakage on aluminum air knives
- Corrosion-resistant finish
- 3" (76.2 mm) flanged air inlet



**Regenerative Blower Assemblies**

- 5.5, 10, 20, 25 and 30 Hp. (4.0, 7.5, 15, 18.5, 22.3 kW)
- Assemblies include pressure relief valve, pressure gauge, air inlet filter, filter monitoring gauge, fittings, mounting adapter for flexible or rigid tubing
- Low maintenance, direct drive operation
- Fan cooling dissipates heat around the bearings to extend wear life
- Continuous, non-pulsating, oil-free air flow
- Low noise
- Rugged cast aluminum construction
- Lightweight
- Tropicalized for corrosion protection
- No heating element; air is warmed by heat generated during operation
- TEFC motors; CE and cURus certified
- Mountable in any position (except F30 which requires vertical mounting)
- Three-phase, dual frequency and multi-voltage motor versions
- Filter monitoring gauge alerts operator when service is required
- Wash down units available



**WindJet® Air Cannons**

- Complete drying by providing a high velocity air stream into holes and indentations in irregularly shaped parts
- Built-in mount spacer simplifies positioning in a mount bracket
- Corrosion-resistant finishes
- Three orifice sizes: .5", .75" and 1" (12.7, 19 and 25.4 mm)

**For complete specifications, performance data and accessories, see WindJet® Air Products, Cat. 20F.**



BLOWER AIR PRODUCT ACCESSORIES

**Mounting Brackets**

- These 100% stainless steel adjustable brackets are used for conveniently mounting air knives. Two specialized mounting plates connect to each end cap on the air knife

Note: Request data sheets 50040 and 55158 for dimensions



**Flexible Tubing**

- High-temperature, steel-reinforced flexible tubing available in 3" and 6" (76.2 and 152.4 mm) diameters and comes in lengths of 10' (3 m). High-torque, worm-gear clamps are available to attach the flexible tubing



**Couplings**

- Unique, easy to use 3" and 6" (76.2 and 152.4 mm) couplings – stainless steel outside, high temperature silicon rubber inside. The couplings compress for use between any rigid connections to prevent air leakage and to add support for the connections. A single built-in clamp is tightened by hand; no special tools are necessary



**Noise Reduction Options**

- Sound Enclosure (shown): Insulating hoods reduce noise by 10 dBa. Metal construction for easy washdown. (Not available for Model F30)

Note: Request data sheet 50218



**Manifolds**

Constructed from high-strength, high-temperature thermoplastic, manifolds allow a single air outlet on the blower to be divided for multiple knives in various ways. Other materials available.

- **Y-divider:** Allows for single inlet to be divided into two outlets. Available in both 3" and 6" (76.2 and 152.4 mm) inlet OD, with 3" (76.2 mm) outlet OD
- **3-port:** Allows for single inlet to be divided into three outlets. Available in both 3" and 6" (76.2 and 152.4 mm) inlet OD, with 3" (76.2 mm) outlet OD. Designed with mounting holes for support
- **4-port (shown):** Allows for single inlet to be divided into four outlets. Available in both 3" and 6" (76.2 and 152.4 mm) inlet OD, with 3" (76.2 mm) outlet OD. Designed with mounting holes for support

Note: Request data sheets 50773 and 50774 for additional dimensions of manifolds.



FOR DETAILED PERFORMANCE DATA, SEE  
WINDJET® AIR PRODUCTS, CAT. 20

All necessary accessories for mounting and implementing the product into your applications are included in the air knife package. Accessories vary by package.

WINDJET® AIR NOZZLES, LOW FLOW AIR KNIVES AND AMPLIFIER OPTIONS

**AA727 WindJet Nozzles**

- Generate efficient, controlled flat fan air pattern for a uniform spray distribution
- Designed to maintain spray pattern integrity
- Available in materials that withstand high temperatures
- Recessed orifices protect against external damage and offer air escape should the nozzles accidentally be placed against a flat surface
- Low noise levels
- Can be mounted side-by-side for air curtain applications
- Compact version available; Y767 is less than half the height of the AA727

**AA707 WindJet Nozzles**

- Produce tightly directed round spray pattern
- Low noise levels
- Color-coded aluminum caps for easy identification of flow rates
- Recessed orifices
- Common uses: debris removal from optical scanners, stock blow-off from rolls, cleaning production areas, sheet control for paper breaks, tissue sheet control, CIP air control system on dry end of tissue machine, air knock-off shower in broke pit and boundary layer air barriers



**WindJet Low Flow Air Knives**

- 3" (8 cm) air knife uses 92% less air than same size pipe with three drilled holes
- Ideal for applications using 1 or 2 air knives
- Deliver a high velocity, constant air stream for fast drying and blow-off
- Reduce energy use
- Lower noise levels, 69 dBa for most applications
- Compact and designed for small areas
- Common uses: sheet control for paper breaks, sheet edge blow-off/knock-off where water is not a viable option, converting plants, bag plants and box plants



**WindJet Variable Air Amplifiers**

- Produce high volume air stream using free air for targeted drying or blow-off
- Allows for adjustability in performance
- Common uses: dust blow-off, broke blow-off in calendar dryer stacks and ventilation



UNIJET® AIR NOZZLE OPTIONS

UniJet Nozzles

- Deliver a wide, uniform flat spray pattern
- Common uses:
  - Blow-off stock from rolls
  - Sheet control for paper breaks
  - Air knock-off shower in broke pit
  - Boundary layer air barriers for coating applications



QUICK REFERENCE GUIDE

Tip Type	Connection/Type	Connection Size in.	Capacity scfm (Nlpm) at 25 psi (2 bar)
L	M or F	1/8, 1/4, 3/8	1.3 (41)
P			2.0 (63)
Q			3.9 (123)
R			6.4 (207)
U			11.0 (354)
V			23 (724)

QUICK REFERENCE GUIDE

Model	Usage Tips/Typical Applications	Connection/Type	Conn. Size in.	Max. Operating Temperature psi (bar)	Materials
AA727 WindJet® Air Nozzle	Narrow flat patterns to create air curtains with multiple tips side-by-side for knockdown or protecting areas	M or F	1/4	<b>At 100 (7)</b>	
				170°F (77°C)	ABS plastic
		M	1/4	<b>At 150 (10.3)</b>	
				500°F (260°C)	Stainless steel
		M	1/4	<b>At 100 (7)</b>	
				180°F (82°C)	Polyphenylene sulfide
450°F (230°C)	Aluminum				
AA707 WindJet Air Nozzle	Round pattern with farther throw distance for keeping sensors clean or spot protection	M	1/4	<b>At 125 (8.6)</b>	
				400°F (204°C)	Polyphenylene sulfide
				220°F (104°C)	PVDF
				450°F (230°C)	Aluminum, stainless steel
180°F (82°C)	ABS plastic				
Y767 WindJet Air Nozzle	Compact version of AA727, can also used to create air curtains with multiple tips side-by-side	M	1/4	<b>At 100 (7)</b>	
				180°F (82°C)	ABS plastic
WindJet Low Flow Air Knives Lengths: 3, 6, 12, 18 and 24 in. (8, 15, 30, 46, and 61 cm)	Provide low consumption air curtains for compact areas	F	1/4	<b>At 200 (13.8)</b>	
				140°F (60°C)	Aluminum with plastic shim
200°F (93°C)	316 stainless steel body and shim				
Air Amplifiers	High volume air stream in focused area for blow-off or sensor protection	F	1/8, 1/4, 3/8, 1/2	–	Aluminum, 316 stainless steel
UniJet Nozzles	Wider flat fan patterns for spacing across spray booms with lower impact force	M	1/8, 1/4, 3/8	–	Brass, Stainless steel





FOR DETAILED PERFORMANCE DATA, SEE WINDJET® AIR PRODUCTS, CAT. 20





# SPRAY GUNS

## TABLE OF CONTENTS

	PAGE
 GunJet® Spray Guns	J2
 GunJet Low Pressure Spray Guns	J3
 GunJet Medium Pressure Spray Guns	J4
 GunJet High Pressure Spray Guns	J4



**OVERVIEW: GUNJET SPRAY GUNS**

**Ideal for: plant clean-up**

- Full range of handheld spray guns ranging from gentle low-pressure to high-impact, high-pressure sprays
- Specially designed handles to improve control and reduce operator fatigue
- Smooth-pull triggers to enable accurate and consistent flow control
- Textured grips to minimize the chance for slippage and accidents
- Wide range of nozzles, extensions, adapters, connectors and strainers available

**Some of the most commonly used products in mills are featured here. For complete specifications and performance data, see GunJet Spray Guns, Cat. 75A.**



**GUNJET SPRAY GUN OPTIONS**

**CU150A Low Pressure Spray Gun**

- Black or white rubber outer cover
- Color bands for easy identification of flow capacities
- Adjustable spray pattern from hollow cone to solid stream
- Optional swivel connectors with trigger lock provide smooth 360° operation, eliminating hose kinking and reducing operator fatigue
- Choice of brass, aluminum or stainless steel body
- Spare parts kit available for easy maintenance, see GunJet Spray Guns, Cat. 75A



FOR MORE OPTIONS, SEE  
GUNJET SPRAY GUNS, CAT. 75

GUNJET® SPRAY GUNS





SPRAY GUNS

**AA70 High Pressure Spray Guns**

- Trigger lock and guard
- Designed to withstand high impact
- Ergonomic design with light trigger pull
- Large grip area to accommodate work gloves
- Vented handle remains comfortable during hot spraying operations
- Optional “weep” feature helps prevent freezing in cold conditions
- In-line swivel provides smooth 360° operation, eliminating hose kinking and reducing operator fatigue
- IMEG, MEG, QCIMEG WashJet® spray tips available.  
See Hydraulic Spray Products, Cat. 75 for performance data



**LOW PRESSURE GUNJET SPRAY GUNS QUICK REFERENCE GUIDE**

Model	Model Type	Max. Operating Pressure psi (bar)	Capacity gpm (lpm)	Max. Temperature °F (°C)	Inlet Conn. Type/Size in.	Outlet Conn. in.
	<b>AA30L</b>	250 (17)	5 (19)	200 (93)	1/4 F	11/16-16 UniJet® THD
	<b>AA60-21580</b>	250 (17)	16 (60)	300 (150)	3/8 F	—
	<b>CU150A</b>	150 (10)	10 to 22 (38 to 83)	200 (93)	1/2 F	—
	<b>AA36</b>	150 (10)	7 (27)	140 (60)	1/4, 3/8 F	1/4, 3/8 F



SPRAY GUNS

GUNJET® SPRAY GUNS

MEDIUM PRESSURE GUNJET SPRAY GUNS QUICK REFERENCE GUIDE

Model	Model Type	Max. Operating Pressure psi (bar)	Capacity gpm (lpm)	Max. Temperature °F (°C)	Inlet Conn. Size/Type in.	Outlet Conn. Size/Type in.
	<b>36533-60</b>	600 (41)	12 (45)	200 (93)	3/8 F	11/16-16 UniJet® THD
	<b>AA23L</b>	250 (17)	5 (19)	200 (93)	1/4 NPS M	11/16-16 UniJet THD
	<b>AA31</b>	500 (35)	5 (19)	200 (93)	1/4 NPS M or NPT or BSPT F	11/16-16 UniJet THD

HIGH PRESSURE GUNJET SPRAY GUNS QUICK REFERENCE GUIDE

Model	Model Type	Max. Operating Pressure psi (bar)	Capacity gpm (lpm)	Max. Temperature °F (°C)	Inlet Conn. Size/Type in.	Outlet Conn. Size/Type in.
	<b>AA30A</b>	1500 (105)	5 (19)	200 (93)	1/4 F	11/16-16 UniJet® THD
	<b>AA60</b>	2500 (175)	6 (23)	300 (150)	3/8 F	11/16-16 UniJet THD
	<b>AA70</b>	5000 (345)	10 (38)	300 (150)	3/8 F	1/4 F
	<b>AA80</b>	3000 (207)	10 (38)	300 (150)	3/8 F	11/16-16 UniJet THD or 1/4, 3/8 F



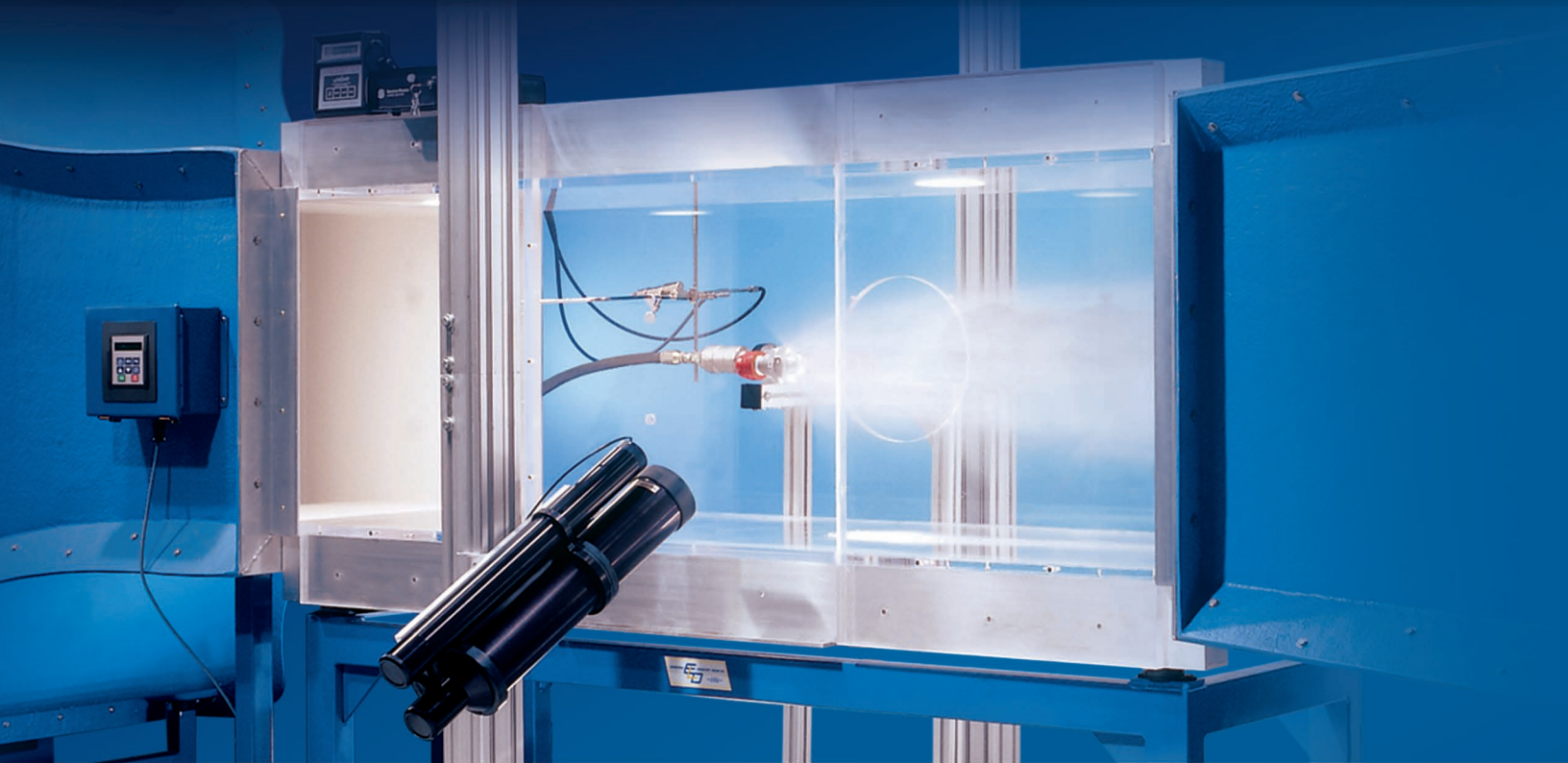

# OPTIMIZATION & SUSTAINABILITY

## TABLE OF CONTENTS

	PAGE
 Ways to improve performance	K2
 Practice preventive maintenance	K7
 Take advantage of our expertise	K9



# WAYS TO IMPROVE PERFORMANCE

## MAKE SURE YOU'RE USING THE BEST PRODUCTS FOR THE OPERATION

Advancements in spray technology can help improve process efficiency and product quality while controlling costs. If you haven't recently evaluated the operations that use spray technology in your mill, you may discover new ways to improve pulping, washing, trimming, coating, converting and other operations. Start by reviewing the information below and then contact your local spray expert for more information.

### AUTOMATIC BRUSH SHOWERS

Improve worker safety while implementing an affordable, automated solution. Automatic Brush Showers allow you to eliminate manual brush operation in existing applications and manual cleaning entirely in new applications. If you have manual brush-type showers, our control unit replaces manual handwheel operation, allowing brush activation via a single push of a button. Aside from gear lubrication twice a year, the Automatic Brush Shower requires no other maintenance time. In addition, the cleaning cycle occurs without interrupting operation, maximizing machine uptime.

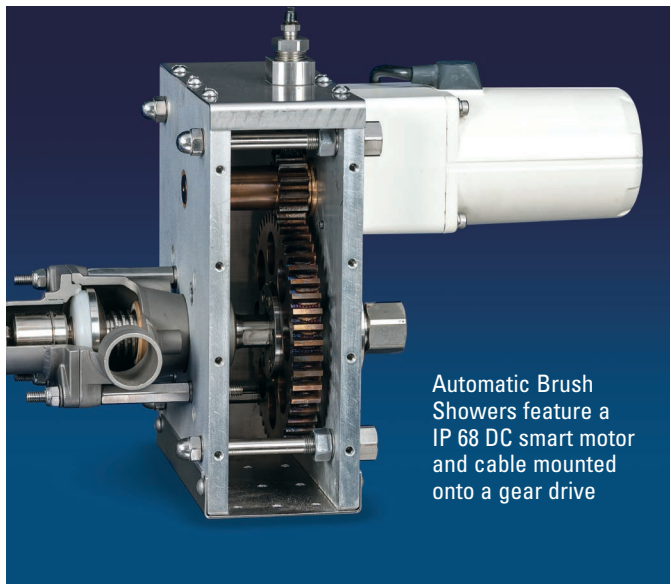

Automatic Brush Showers feature a IP 68 DC smart motor and cable mounted onto a gear drive

### AUTOMATIC SPRAY CONTROL

If your operations require precise, uniform application of costly coatings or moisture, an automated spray system may provide a quick return on investment by reducing waste and scrap. A wide range of dedicated spray controllers is available offering everything from simple on/off control to total automation. Typical benefits of spray control include:

- Quality is improved – under and over-application problems are eliminated, reducing scrap. Some spray controls can adjust the application rate based on changes in operating conditions such as line speed
- Overspray is minimized – chemical and coating waste are eliminated lowering operating costs and improving worker safety

Automated spray systems are being used in mills around the world in operations like these:

- Automatic activation of individual nozzles or a zone of nozzles based on paper width to eliminate scrap during changeover or downtime to change spray set-ups
- Precise control of moisture. The spray controller automatically adjusts the flow rate based on input from a moisture sensor to ensure proper wetting
- Defect detection. The spray controller triggers nozzles to spray based on input received from a vision system

### PRECISION SPRAY CONTROL (PSC)

PSC helps reduce chemical use while ensuring uniform application of coatings. PSC is achieved by turning electrically-actuated spray nozzles on and off very quickly to control flow rate.

**Benefits include:**

- Reduces scrap caused by over- or under-application of coatings
- Reduces the use of costly coatings by applying the proper coating volume directly on the target
- Increases production – fast cycling (up to 25,000 cycles per minute) of nozzles keeps pace with high line speeds

### AUTOMATED TANK/CHEST CLEANING PRODUCTS

If chests and tanks in your mill are being cleaned manually or via fill and drain methods, consider improving worker safety and reducing costs with automated tank cleaning equipment. Automated tank cleaning efficiently, effectively and safely cleans stock chests, black liquor storage chests, pulp towers and more. Some mills have reported saving up to USD\$50,000 per year per stock chest by changing to automated tank cleaning equipment.

### NOZZLES

New nozzle designs offer greater precision, better efficiency and longer wear life. Some examples are:

- Clog-resistant designs minimize performance problems and unscheduled downtime
- Quick-connect styles reduce maintenance time in yankee chemical showers or critical alignment applications
- One-piece, high-pressure ShowerJet nozzles simplify installation and removal by integrating the nut and gasket into the nozzle design

Making a small investment in time to review your showers and chest cleaning operations can result in big savings. You may discover new ways to improve efficiency and lower operating costs.



## PERFORM REGULAR NOZZLE INSPECTIONS

Spray nozzles are at the heart of all the applications that use consumables throughout the mill. These seemingly simple components have a significant impact on performance and operating costs in moisturizing, cleaning, lubricating, edge trimming, bleaching, knock-off, gluing and dozens of other applications.

Like all precision components, spray nozzles will wear over time with use and should be monitored and maintained according to a schedule. It's important to determine the wear rate for your application. For example, shower nozzles that are used for trimming, separating the formed edge and creating a cleaner edge have a very high wear rate. When

nozzles are worn, the patterns break up and can cause an irregular cut. A good maintenance program to replace the nozzles regularly will help prevent issues due to worn nozzles.

Even slight wear can cost tens of thousands of dollars annually in increased operating expenses. As spray nozzles wear, their orifices become larger and, at any given pressure, the flow rate increases. Worn nozzles that spray over capacity are wasting more than water. Electricity costs will rise due to excess pump operation and chemical costs will also increase.

### HERE ARE TWO EXAMPLES THAT ILLUSTRATE THE EXPENSE AND WASTE ASSOCIATED WITH USING WORN NOZZLES.

**EXAMPLE #1: DRYER SECTION SHOWER** – One shower with 70 nozzles spraying a release agent on dryer felt

**OPERATING CONDITIONS:**

- System sprays 5 gpm (19 lpm) of a 1:20 aqueous solution of chemical at 40 psi (2.76 bar)
- Chemical consumption: .25 gpm (.95 lpm); \$0.50 per gallon
- Operation: Three shifts, five days per week = 120 hours per week

**15% NOZZLE WEAR = 15% INCREASE IN WATER, CHEMICAL & ELECTRICITY COSTS**

Water expense:	\$6,135
Chemical expense:	\$53,820
Electricity expense:	\$3,118
<b>Total operating costs at 15% wear:</b>	<b>\$63,073</b>

Note: Does not include water filtration and recovery costs. All costs are in USD.

The cost to operate this one shower increases from \$54,803 to \$63,073. **If you have six showers in the dry end, your costs increase by \$49,620 annually.**

**Use our online Nozzle Wear Calculator to help expedite your calculation: [www.spray.com](http://www.spray.com)**

**EXAMPLE #2: FABRIC CLEANING SHOWER** – One shower with 72 high-pressure nozzles

**OPERATING CONDITIONS:**

- Nozzle size: 2.34 gpm (8.8 lpm) at 350 psi (24.1 bar)
- Operation: 60 hours per week, 48 weeks per year

**15% NOZZLE WEAR = WASTE OF MORE THAN 4,000,000 GALLONS OF WATER ANNUALLY FOR ONE SHOWER**

Increased capacity for the shower: 168.5 to 193.8 gpm (637.8 to 733.4 lpm)

**Increased annual water consumption: 4,367,002 gallons (16,531 kiloliters)**

There are 660,430 gallons of water in an Olympic-sized pool.

The water wasted each year from this one shower alone is enough to fill nearly seven Olympic-sized pools. Meet your commitment to reduce water consumption waste by replacing nozzles regularly.



Protecting the Environment Through Process Optimization





## LOWER UTILITY BILLS BY IMPROVING BLOW-OFF AND DRYING EFFICIENCY

Many mills use pipes with drilled holes or slits for drying or blow-off. This approach consumes high volumes of costly compressed air. Use of compressed air nozzles or air knife packages powered by regenerative blowers are good alternatives and can dramatically reduce energy consumption.

### COMPRESSED AIR NOZZLES

Compressed air nozzles convert low-pressure volumes of air into a targeted, high-velocity stream or flat fan air patterns and provide many benefits:

- Significant improvements in drying or blow-off by increasing impact on the target
- A significant decrease in air consumption compared to open holes or slits in pipes
- Reduced noise level

### AIR KNIFE PACKAGES WITH BLOWER AIR

Using regenerative blowers and air knives eliminates the need for compressed air. Regenerative blower benefits include:

- Low noise operation
- Low maintenance
- Dependable operation and long wear life
- Low operating costs
- Improved drying due to warm air use

Air knives produce a uniform, high-volume, constant air stream along the entire knife length. The result is uniform, complete drying without blotches or spotting or highly efficient blow-off.

WindJet® Air Knife packages are customizable based on application requirements.



#### SIGNIFICANT SAVINGS OPPORTUNITY:

A single operation in a mill using a 4' (1.2 m) pipe with slits can cost	\$350,000+ annually
--	---------------------

Different approaches to drying and blow-off can cost just	\$30,500 annually
---	-------------------

<b>A possible savings of more than</b>	<b>\$300,000 per year</b>
--	---------------------------

Note: All costs are in USD.

The cost of a new drying or blow-off system is quickly offset by the tremendous savings in operating expenses.

**Your local spray expert can help you compare the options and costs of using compressed air nozzles versus air knife packages with blower air.**

## ASK FOR EXPERT HELP

Our local spray experts are available to help evaluate your operations and identify ways to improve performance.

### Nozzle wear

In most cases, nozzle wear is difficult to detect because it isn't visible. The gradual erosion of nozzle orifices can't be seen when inspecting the nozzle or observing the spray. Measuring nozzle flow rate is generally required so actual flow rate can be compared to the rated flow rate. In other cases, the most effective way to determine wear rate and determine the optimal replacement interval is to evaluate the worn nozzles in our spray laboratories using specialized test equipment.

### Complimentary visual inspections

- Occur while machine is running
- Include visual inspection of all showers and nozzles on the machine for obvious spray problems
- Include documentation of nozzle and shower locations
- Include a written report of inspection results along with recommendations for operational enhancements if appropriate

### Complimentary nozzle audits

- Occur during shut-down
- Include an inspection of all nozzles on the machine; size and condition of nozzles are noted
- Include identification of nozzles that need replacement
- Can be completed in one to four hours depending on machine
- Include a written report with optimization tips, documentation on every nozzle and shower by location and maintenance recommendations

**Contact your local spray expert today for on-site assistance.**

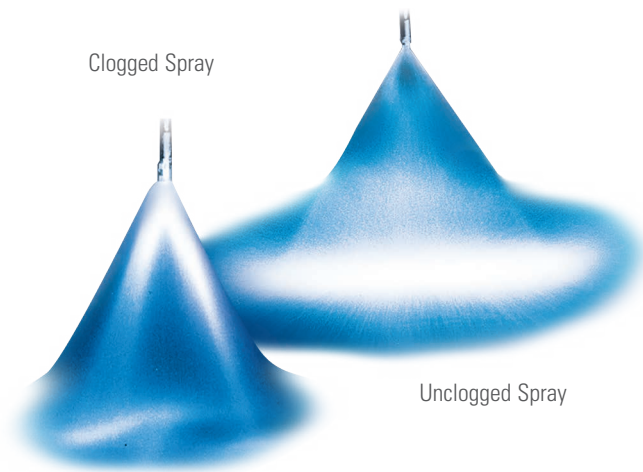

# PRACTICE PREVENTIVE MAINTENANCE

## MAINTENANCE TIPS

Implement these tips into your maintenance programs to extend product life and minimize downtime.

### PLUGGING

- Use proper water clarification devices
- Use strainers
- Be sure to specify nozzles with adequate free passage
- Conduct maintenance on a regular basis
- Use automated self-cleaning showers

### CORROSION

- Specify nozzles in the appropriate materials: 316 or 303 stainless steel bodies and synthetic ruby or ceramic orifices depending on chemical concentration. Avoid iron and mild steel

### SCALE BUILD-UP

- Control hardness level of the water
- Use chemical additives as needed
- Conduct maintenance on a regular basis

### SLIME AND ODOR

- Implement an effective biocide program to control biological growth
- Use chemical additives as needed
- Eliminate areas with stagnant water
- Conduct frequent wash-ups

### CAKING

- Conduct maintenance on a regular basis



**NOZZLE MAINTENANCE GUIDELINES**

- Examine spray patterns and watch for changes in spray angles, distribution and heavy edges
- Wear may be hard to detect so go beyond visually inspecting nozzles. Check flow rate and spray pressure at a system level
- The nozzle orifice is precision engineered so be careful to avoid damage or replacement will be necessary
- Cleaning tools should be significantly softer than the construction material of the nozzles, such as a toothbrush, toothpick or brushes in the showers. Never clean the orifice with metal objects
- Soak nozzles in mild solvent to loosen debris for easier removal with proper equipment

**NOZZLE WEAR IS DIFFICULT TO DETECT BUT WORTH THE EFFORT TO PREVENT WASTE**

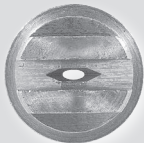

GOOD SPRAY TIP

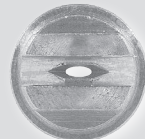

WORN SPRAY TIP

Nozzle tips show little visible difference. The tip on the left is new. The same size tip shown to the right has worn to the point at which it sprays 30% over capacity. Visual inspection shows little evidence of wear.

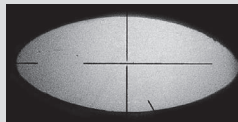

GOOD SPRAY TIP

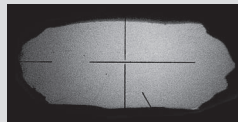

WORN SPRAY TIP

Orifice viewed through an optical comparator shows evidence of internal wear. A closer inspection and an analysis of spray collection data shown in the image on the right reveal the difference between the two tips.

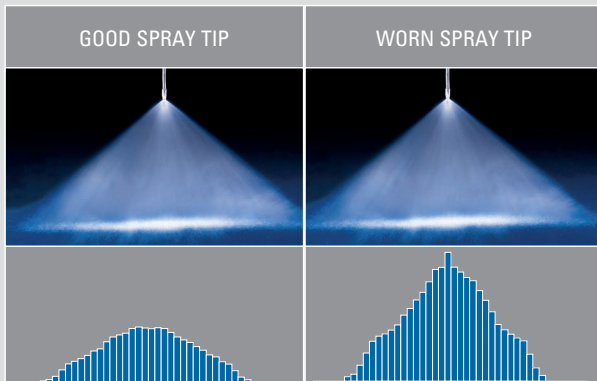

Spray patterns of both tips show little difference. Spray collection in tubes gives dramatic evidence of 30% increase in capacity.

**NOZZLE MATERIAL**

Nozzles made from harder materials generally provide longer wear life. In addition to standard materials such as brass and stainless steel, more durable spray nozzles are often available in specialty materials, carbides or with ruby orifices. Nozzles with a synthetic ruby orifice are frequently used for web trimming because they provide up to 2000 times greater wear resistance than brass. In addition, the stream remains steady even in the early stages of wear. Many solid stream shower nozzles also are available with ruby orifices to help extend wear life and ensure proper cleaning of fabrics for longer periods of time.

To help determine if you should consider a change, the standard abrasion resistance ratios for many of these materials are listed below.

**APPROXIMATE ABRASION RESISTANCE RATIOS**

Spray Nozzle Material	Resistance Ratio
Aluminum	1
Brass	1
Polypropylene	1-2
Steel	1.5-2
Stainless Steel	4-6
Hardened Stainless Steel	10-15
Silicon Carbide (Nitride Bonded)	90-130
Ceramics	90-200
Carbides	180-250
Synthetic Ruby or Sapphire	600-2000

**SELF-CLEANING NOZZLES OR STRAINERS**

In many applications, orifice deterioration and clogging are caused by dirt particles in the sprayed liquid. This is particularly common in systems using continuous spray water recirculation. In an average production process, recycling of water enables approximately 17 uses before discharge, as opposed to one or two uses without recirculation.

Self-cleaning nozzles feature a piston-type design. When line pressure is low, the piston retracts to purge debris from the nozzle orifice. Self-cleaning nozzles are ideal for use inside showers and machines because of their compact design.

Strainers, or nozzles with built-in strainers, trap larger particles and prevent debris from entering the nozzle orifice or vane to significantly reduce wear.

# TAKE ADVANTAGE OF OUR EXPERTISE



## EXPERT ADVICE IS RIGHT WHERE YOU NEED IT – IN YOUR MILL BY LOCAL EXPERTS

Our specialty is finding ways to improve efficiency in operations and help you achieve greater profitability and sustainability. For example, one tissue manufacturer was able to develop a coreless tissue line that allows more sheets of tissue to be wound on each roll using an AutoJet® spray system. Eliminating the cardboard tubes and plastic end caps has generated an annual savings of over USD\$40,000 and removed the tubes and end caps from the waste stream.

### COMPLIMENTARY LUNCH AND LEARN WORKSHOPS

Select a topic, choose a date and invite your colleagues. We'll provide lunch and an informative 60-minute session. Popular topics include How to Reduce Water and Energy Use, How to Optimize Transfer Efficiency, Maintenance Workshops and more.

### TESTS AND DEMONSTRATIONS AVAILABLE AT REGIONAL SPRAY TECHNOLOGY CENTERS

Throughout North America, we have several Spray Technology Centers. These facilities are equipped to conduct proof-of-concept tests and technology demonstrations. Seminars including live demonstrations on various topics are also conducted throughout the year. Schedules vary by region so contact your local spray expert for information.



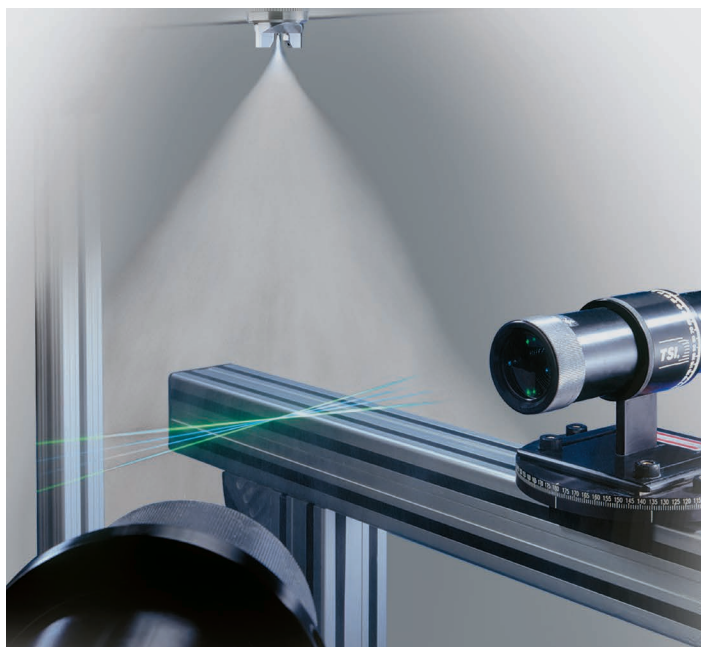

### RESEARCH SERVICES THAT OPTIMIZE CHALLENGING OPERATIONS

Many spray operations require high precision and there is little or no margin for error. For example, if you're spraying glues, starches, adhesives or other coatings, selecting correct nozzles and determining optimal nozzle spacing, height and position can be challenging. In addition, nozzle clogging and frequent process interruptions are unacceptable so it is important to select the best nozzle for spraying viscous liquids. In our state-of-the-art spray laboratories, we can simulate your operating conditions using your chemicals/liquids to determine how to achieve the exact performance you need. Conducting spray performance testing prior to nozzle and shower selection in new applications or in critical operations helps ensure optimal performance.

### BUILT-TO-ORDER SHOWERS AND HEADERS

When a standard shower doesn't provide the required performance or fit into your current environment, we can design and fabricate one that will. Built-to-order showers are available in a wide range of styles – brushless, brush-type, air atomizing, oscillating and more. Shower length, number and placement of nozzles, connections and more can be customized.

**Let us show you why mills around the globe rely on us to help boost production, improve paper and tissue quality, lower operating costs, minimize waste and more.**

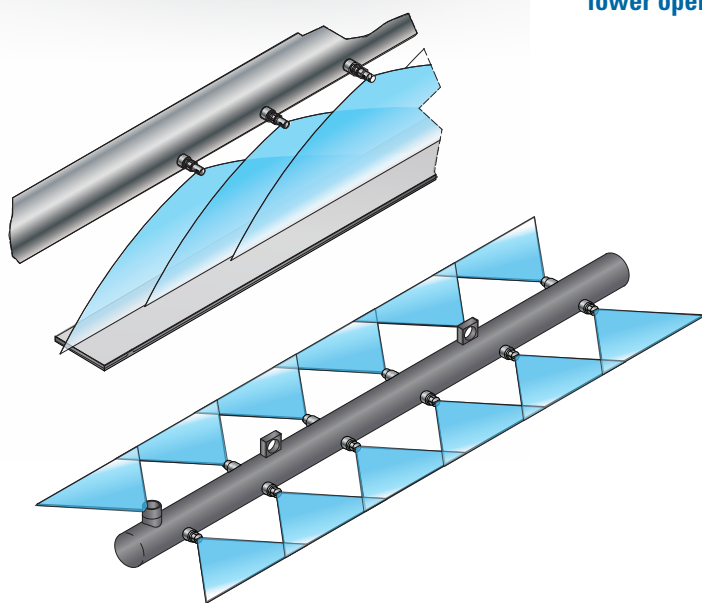

INDEX



**AIR KNIFE PACKAGES & AIR NOZZLES**

AA707 WindJet® ..... I5  
 AA727 WindJet..... I5  
 Air Amplifiers ..... I5  
 Air Cannons ..... I4  
 Air Knives ..... I3, I5  
 Regenerative Blower Assemblies ..... I3  
 UniJet® ..... I6  
 Y767 WindJet ..... I6  
 Accessories ..... I7

**AUTOMATIC & AIR ATOMIZING NOZZLES**

**Air Atomizing**

1/4J ..... G8  
 1/8J ..... G8  
 1/8JJ ..... G9

**Air-Actuated Air Atomizing**

1/4JAU ..... G6  
 1/8JJAU ..... G6  
 10535-1/4J ..... G7  
 VAU ..... G7  
 VMAU ..... G7

**Electrically-Actuated Air Atomizing PulsaJet®**

AA10000JJAU ..... G5  
 AA10000JAU-10 ..... G5

**Electrically-Actuated Hydraulic PulsaJet**

AA10000AUH-03 ..... G4  
 AA10000AUH-10 ..... G4

**Fogging & Humidification**

1/4JH ..... G11, G12  
 1/4JT ..... G11, G12  
 45400 ..... G12  
 45265 ..... G10  
 45269 ..... G10  
 55089 ..... G12  
 YMF MiniFogger® III ..... G11

**FLAT SPRAY NOZZLES**

**Black Liquor**

45824 Splash Plate ..... E7  
 VeeJet® U ..... E7

**FlatJet® Narrow Angle Spray**

115220 ..... E11  
 P ..... E11

**FloodJet® Wide Angle Spray**

11499 ..... E10  
 13063 ..... E10  
 K ..... E10

**Quick-Change QuickJet® Standard Spray**

58106 ..... E5  
 QJA ..... E5  
 QJJA ..... E5  
 QUA ..... E5  
 QVVA ..... E5

**UniJet® Standard Spray**

13802 ..... E6  
 49803 ..... E6  
 58102 ..... E6  
 T ..... E6  
 TPU ..... E6  
 TT ..... E6, E9

**Quick-Change QuickJet Wide Angle Spray**

QJA ..... E8  
 QJJA ..... E8  
 QJJS ..... E8  
 QSTK ..... E8  
 QTKA ..... E8

**Quick-Change UniJet Wide Angle Spray**

T ..... E9  
 TK ..... E9  
 TT ..... E6, E9

**Quick-Change QuickJet Narrow Angle Spray**

QLPA ..... E12

QJLA ..... E12  
 QJJLA ..... E12

**VeeJet®**

H-DT ..... E4  
 H-DU ..... E4  
 H-VV ..... E4  
 H-VVL ..... E4  
 U ..... E4

**GUNJET® SPRAY GUNS**

36533-60 ..... J4  
 AA23L ..... J4  
 AA30A ..... J5  
 AA30L ..... J3  
 AA31 ..... J4  
 AA36 ..... J3  
 AA60 ..... J5  
 AA60-21580 ..... J3  
 AA70 ..... J3, J5  
 AA80 ..... J5  
 CU150A ..... J2, J3

**HOLLOW CONE NOZZLES**

**SpiralJet Standard Angle Spray**

BSJ ..... F4

**WhirlJet Standard Angle Spray**

AP ..... F4  
 AX ..... F3  
 BD ..... F4  
 BDM ..... F4  
 BX ..... F3  
 CF ..... F3  
 CRC ..... F3  
 CX ..... F3  
 D ..... F3  
 LAP ..... F4  
 LBP ..... F4

**WhirlJet Wide Angle Spray**

AP-W ..... F4  
 AX-W ..... F3  
 BX-W ..... F3  
 LAP-W ..... F4  
 LBP-W ..... F4





**SHOWER NOZZLES**

**DiscJet®**

25834 . . . . . C8  
 48284 . . . . . C8  
 DJ . . . . . C8  
 DK . . . . . C8

**NeedleJet**

19124 . . . . . C6  
 20094 . . . . . C7  
 21280 . . . . . C7  
 22812 . . . . . C7  
 39458 . . . . . C7  
 48277 . . . . . C7  
 48460 . . . . . C6  
 56740 . . . . . C7  
 P36503 . . . . . C6

**ShowerJet Disc-type**

27149 . . . . . C4  
 39350 . . . . . C4  
 39485 . . . . . C4  
 48546 . . . . . C4  
 50790 . . . . . C4

**Lock Rings**

27044 . . . . . C5  
 28376 . . . . . C5  
 29676 . . . . . C5  
 29677 . . . . . C5  
 31250 . . . . . C5

**ShowerJet One-piece,  
High-pressure**

37337 . . . . . C3  
 38553 . . . . . C3  
 39468 . . . . . C3  
 73196 . . . . . C3  
 73227 . . . . . C3

**Self-cleaning**

20210 . . . . . C9  
 20235 . . . . . C9  
 26225 . . . . . C9  
 26411 . . . . . C10  
 36090 . . . . . C10  
 38332 . . . . . C10  
 38490 . . . . . C10

49905 . . . . . C10  
 72370 . . . . . C10

**SHOWERS**

Automatic Brush . . . . . B2  
 PulsaJet® Manifold . . . . . B2  
 AutoJet® Self-Cleaning Web Lamination . . . . . B3  
 AutoJet Oscillator Shower Assembly . . . . . B3  
 Air Atomizing . . . . . B4  
 Pipe-in-Pipe Air Atomizing . . . . . B4  
 Brushless . . . . . B5  
 Spray Control Options . . . . . B5

**CHEST CLEANERS**

**TankJet®**

9 A, B & C . . . . . H6  
 14 . . . . . H6  
 16 . . . . . H5  
 19 . . . . . H6  
 65 . . . . . H4  
 65HT . . . . . H4  
 75 . . . . . H5  
 78 . . . . . H3, H4  
 78D . . . . . H4  
 80 . . . . . H4  
 180 . . . . . H4  
 360 . . . . . H2, H4  
 6353 . . . . . H3, H6  
 6353-MFP . . . . . H6  
 8310A . . . . . H8  
 12900 . . . . . H5  
 18250A . . . . . H6  
 21400A . . . . . H7  
 23240-2 . . . . . H7  
 23240-3 . . . . . H7  
 27500 . . . . . H3, H5  
 27500-R . . . . . H5  
 28500 . . . . . H5  
 28500-R . . . . . H5  
 30473 . . . . . H7  
 63225 . . . . . H6  
 AA090 . . . . . H5  
 AA124/AA430 . . . . . H8  
 AA190 . . . . . H3, H4  
 AA290 . . . . . H2, H4  
 D26564 . . . . . H6  
 D26984 . . . . . H5

D40159 . . . . . H5  
 D41800E . . . . . H5  
 D41892 . . . . . H6  
 D41990 . . . . . H6  
 M60 . . . . . H6  
 VSM . . . . . H7  
 YMD3 . . . . . H4

**Strainers**

8310A . . . . . H8  
 AA124/AA430 . . . . . H8  
 TWD . . . . . H8

**WEB TRIMMING**

**Adapters**

39290 Swivel Adapter . . . . . D3  
 87529 Air Barrier Adapter . . . . . D3

**Alignment Devices**

115450 . . . . . D4  
 13802 . . . . . E6  
 36533-60 . . . . . J4  
 Y72020 . . . . . D4

**UltraStream Nozzles**

38170 . . . . . D2  
 38171 . . . . . D2  
 48461 . . . . . D2  
 39610 Swivel . . . . . D2  
 72242 . . . . . D2  
 58035-2 . . . . . D2  
 56795-2 . . . . . D2

**Trimming Feed Converters**

115425 . . . . . D3  
 115427 . . . . . D3



**SPRAYING SYSTEMS CO.'S TRADEMARK USAGE**

The following is a current list of Spraying Systems Co.'s trademarks registered in the United States. Some marks are registered in other countries as well.

AirJet®	FloodJet®	QuickJet®	VeeJet®
AutoJet®	FogJet®	RotoClean®	WashJet®
DiscJet®	FullJet®	SpiralJet®	WhirlJet®
DripSafe™	GunJet®	TankJet®	WindJet®
FlatJet®	MiniFogger®	UniJet®	

Spraying Systems Co. reserves the right to make changes in specifications or design of the products shown in the catalog or to add improvements at anytime without notice or obligation.





***Spraying Systems Co.***<sup>®</sup>  
Experts in Spray Technology

North Avenue and Schmale Road, P.O. Box 7900, Wheaton, IL 60187-7901 USA

Tel: 1.800.95.SPRAY    Intl. Tel: 1.630.665.5000

Fax: 1.888.95.SPRAY    Intl. Fax: 1.630.260.0842

Email: [info@spray.com](mailto:info@spray.com)

[www.spray.com](http://www.spray.com)



Catalog 66 C

© 2018 Spraying Systems Co. All rights reserved. Full protection of law claimed under Universal Copyright and Berne Conventions and other applicable national and international laws.