



FOR TANK DIA. UP TO **5 ft.**  
(1.5 m)

WINE BARRELS • PIPES & DUCTS  
SMALL PROCESSING TANKS • TUBES  
CYLINDERS • DRUMS & KEGS  
PHARMACEUTICAL VESSELS  
FOOD VATS



TANK DIA. UP TO 5 FT. (1.5 M)  
I N T R O D U C T I O N



## QUICKLY CLEAN AND RINSE BARRELS AND TANKS

EFFICIENT WASHING AND CLEANING OF BEVERAGE CONTAINERS AND SMALLER VESSELS.

Rely on this series of nozzles when containers require a quick turnaround. Their long wear life and compact design make these TankJet nozzles ideal for beverage containers and smaller vessels.





## QUICK REFERENCE GUIDE

Nozzle	Cleaning Power	Max. Tank Diameter ft. (m)	Operating Principle	Flow Rate Range gpm (lpm)	Operating Pressure psi (bar)	Spray Coverage	Max. Temperature °F (°C)	Materials	Page Number
<b>TankJet® M60</b>	High impact	5 (1.5)	Air motor-driven	1.1 to 10.1 (4.2 to 38)	100 to 1000 (6.9 to 69)	360°	180 (82)	316 stainless steel, carbon graphite PTFE, filled PEEK, EPDM, and PTFE	F4
<b>TankJet D26564</b>	Rinsing	5 (1.5)	Fluid-driven reactionary force	2.4 to 5.4 (9.0 to 20.5)	14.5 to 72.5 (1.0 to 5.0)	180° up/down	194 (90)	PVDF	F6
<b>TankJet 21400A</b>	Rinsing	5 (1.5)	Fluid-driven reactionary force	5.0 to 22 (23 to 82)	10 to 60 (0.7 to 4.1)	360°	350 (177)	Bearing Retainers – stainless steel Sleeves – 50% stainless steel PTFE All other metallurgy – 316 stainless steel with Ryton® (polyphenylene sulfide)	F7
<b>TankJet VSM</b>	Rinsing	5 (1.5)	Stationary	2.7 to 72 (10.4 to 269)	10 to 150 (0.7 to 10.3)	240° down	200 (93)	Nylon	F8
<b>TankJet 30473</b>	Rinsing	3 (0.9)	Fluid-driven reactionary force	2.1 to 4.5 (7.8 to 18.0)	10 to 50 (0.7 to 3.4)	180° up/down, 360°	200 (93)	PTFE	F9
<b>TankJet 23240-2 23240-3</b>	Rinsing	3 (0.9)	Fluid-driven reactionary force	3.5 to 22 (14.0 to 79)	20 to 200 (1.4 to 13.8)	360°, side spray	350 (177)	316 stainless steel, hardened stainless steel and 50% stainless steel-filled PTFE	F10



**TANKJET M60 TANK CLEANER  
FEATURES AND BENEFITS**

- Powerful cleaning using low flow rates
- Removes tough residues quickly and effectively; solid stream sprays rotate in multiple axes for complete and thorough coverage
- Mobile – can easily be moved from one barrel or drum to the next
- Fast cycle time; less than 5 minutes. One full cycle completed every 16 revolutions
- Compact – fits in openings as small as 1-3/4 in. (44.5 mm) and easily inserted into standard bung hole openings
- Compatible with a variety of pumps including pressure washers
- Material construction in contact with fluid: stainless steel, carbon graphite PTFE-filled PEEK, EPDM, and PTFE
- Non-lubricated, air motor driven for continuous and reliable operation
- Easy to operate and rebuild
- See case study on page F12

**SPECIFICATIONS**

TankJet M60 Tank Cleaner	
Max. tank diameter:	5 ft. (1.5 m)
Operating principle:	Air motor-driven
Flow rate:	1.1 to 10.1 gpm (4.2 to 38 lpm)
Operating pressure:	100 to 1000 psi (6.9 to 69 bar)
Max. temperature:	180°F (82°C)
Materials:	316 stainless steel, carbon graphite PTFE-filled PEEK, EPDM, and PTFE
Liquid connection:	3/8" NPT or BSPT (F)
Air line connection:	1/4" NPT or BSPT (F)
Optional accessories:	Strainers, recommended mesh size: 100 (150 microns) See page G2

**IDEAL FOR CLEANING:**

- Wine barrels
- Drums and kegs
- Food and beverage barrels
- Chemical and storage barrels
- Small tanks and containers

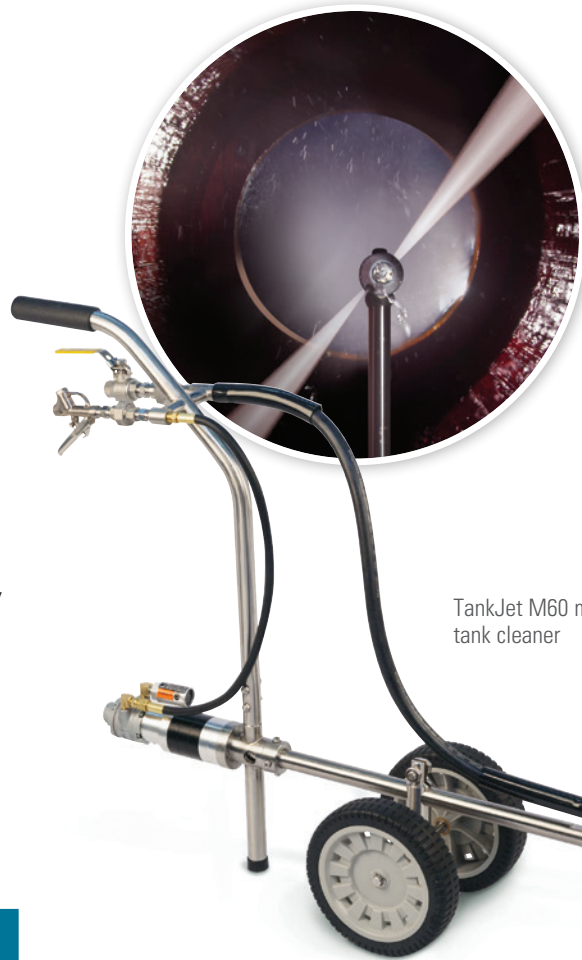

TankJet M60 mobile tank cleaner

**DIMENSIONS AND WEIGHTS**

Model	A in. (mm)	B in. (mm)	C in. (mm)	D in. (mm)	E in. (mm)	F in. (mm)	G in. (mm)	Min Tank Opening in. (mm)	Weight lbs. (kg)
TJM60AG	35.0 (891)	21.4 (543)	29.0 (742)	25.5 (647)	7.0 (177)	10.4 (265)	9.25 (235)	1.75 (44.5)	26 lbs. (11.8 kg)

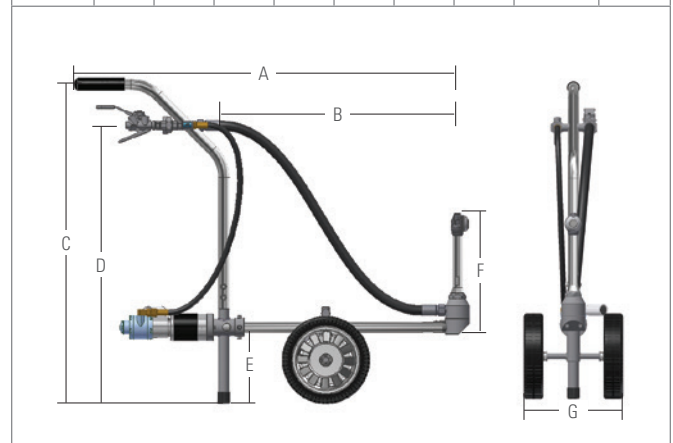

**PERFORMANCE DATA**

Model	Orifice Size	Liquid Flow Capacity gpm (lpm)						
		100 psi (6.9 bar)	200 psi (13.8 bar)	300 psi (20.7 bar)	400 psi (27.6 bar)	500 psi (34.5 bar)	700 psi (48.3 bar)	1000 psi (68.9 bar)
TJM60AG	046	1.1 (4.2)	1.6 (6.1)	1.9 (7.1)	2.2 (8.7)	2.5 (9.4)	2.9 (11.2)	3.5 (13.3)
	055	1.6 (6.0)	2.3 (8.8)	2.8 (10.2)	3.2 (12.5)	3.6 (13.4)	4.2 (16.1)	5.0 (19.0)
	060	1.9 (7.2)	2.7 (10.5)	3.3 (12.1)	3.8 (14.8)	4.2 (16.0)	5.0 (19.1)	6.0 (22)
	066	2.3 (8.7)	3.2 (12.7)	4.0 (14.6)	4.6 (17.9)	5.1 (19.4)	6.1 (23)	7.2 (27)
	078	3.2 (12.1)	4.5 (17.7)	5.5 (20)	6.4 (25)	7.2 (27)	8.5 (32)	10.1 (38)

**NON-LUBRICATED AIR MOTOR (AG)  
CYCLE TIME DATA**

Air Pressure psi (bar)	Air Consumption scfm (lpm)	Approx. Speed (rpm) 1000 psi/180°F (69 bar/82°C)	Approx. Time for One Complete Cycle (min.)
10.0 (0.7)	3.9 (108)	3.5	4.5
12.0 (0.85)	4.7 (136)	4.5	3.5
15.0 (1.0)	5.9 (162)	6.0	2.7
20 (1.4)	7.8 (224)	9.5	1.7

\*Cycle time refers to the time it takes to complete one full cycle. One full cycle is completed every 16 revolutions.

**ORDERING INFORMATION  
TANKJET M60 TANK CLEANER**

Model*	-	Orifice Size	EXAMPLE	TJM60AG	-	055
--------	---	--------------	---------	---------	---	-----

\*Add B for BSPT connections after the model type.



**TANKJET D26564 TANK CLEANING NOZZLE  
FEATURES AND BENEFITS**

- Compact design ideal for tanks or containers with small openings
- Ideal for rinsing small tanks and containers, the fast rotating nozzle provides thorough coverage over the vessel surface
- No motor source is required as the force of the liquid provides the spray head rotation
- Corrosion and chemical resistant materials of construction

**SPECIFICATIONS**

TankJet D26564 Tank Cleaning Nozzle	
Max. tank diameter:	5 ft. (1.5 m)
Operating principle:	Fluid-driven reactionary force
Flow rate:	2.4 to 5.4 gpm (9.0 to 20.5 lpm)
Operating pressure:	14.5 to 72.5 psi (1.0 to 5.0 bar)
Max. temperature:	194°F (90°C)
Materials:	PVDF
Inlet connection:	1/2" and 3/8" NPT or BSPT
Optional accessories:	Strainers, recommended mesh size: 200 (74 microns) See page G2

**IDEAL FOR CLEANING:**

- Small containers

**PERFORMANCE DATA**

Model	Capacity, gpm (lpm)		
	14.5 psi (1.0 bar)	50.8 psi (3.5 bar)	72.5 psi (5.0 bar)
D26564	2.4 (9.0)	4.5 (17)	5.4 (20.5)

**ORDERING INFORMATION**

**TANKJET D26564**

Model	Spray Coverage	Inlet Conn. Size*	Material Code**
-------	----------------	-------------------	-----------------

EXAMPLE: **D26564** - **A** - **1/2** - **KY4**

\*Add B prior to the inlet connection for BSPT connections.

\*\*Material code for PVDF is KY4



TankJet D26564 tank cleaning nozzle

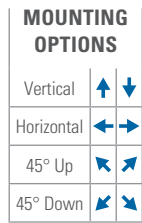
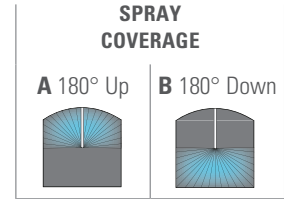

**DIMENSIONS AND WEIGHTS**

Model	Inlet Conn. Size in.	L in. (mm)	W in. (mm)	D in. (mm)	Min. Tank Opening in. (mm)	Weight lbs. (kg)
D26564	1/2	2.8 (70)	1.1 (27)	1.4 (35)	1.5 (37)	0.1 (.04)
	3/8		0.94 (24)			

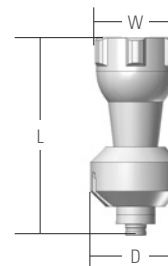

**TANKJET 21400A TANK CLEANING NOZZLE  
FEATURES AND BENEFITS**

- Three flat sprays mounted in a rotating spray head are driven by the flow of the cleaning liquid
- Precisely positioned orifices provide complete orbital coverage of all interior surfaces
- Constructed for long wear life and to tolerate high-temperature operation using corrosion-resistant materials
- Using single-pass or particulate-free cleaning liquid optimizes cleaning performance

**SPECIFICATIONS**

TankJet 21400A Tank Cleaning Nozzle	
Max. tank diameter:	5 ft. (1.5 m)
Operating principle:	Fluid-driven reactionary force
Flow rate:	5 to 22 gpm (23 to 82 lpm)
Operating pressure:	10 to 60 psi (0.7 to 4.1 bar)
Max. temperature:	350°F (177°C)
Materials:	Bearing Retainers – stainless steel Sleeves – 50% stainless steel PTFE All other metallurgy – 316 stainless steel with Ryton® (polyphenylene sulfide)
Inlet connection:	3/4" NPT or BSPT (F)
Optional accessories:	Strainers, recommended mesh size: 200 (74 microns) See page G2

**IDEAL FOR CLEANING:**

- Barrels
- Chemical tanks
- Food vats
- Processing vessels

**PERFORMANCE DATA**

Model 21400A	Capacity, gpm (lpm)					
	10 psi (0.7 bar)	20 psi (1.4 bar)	30 psi (2.1 bar)	40 psi (2.8 bar)	50 psi (3.4 bar)	60 psi (4.1 bar)
Capacity Size						
10	5.0 (23)	7.1 (28)	8.7 (32)	10.0 (36)	11.2 (39)	12.2 (46)
18	9.0 (41)	12.7 (50)	15.6 (58)	18.0 (65)	20 (71)	22 (82)

**ORDERING INFORMATION**

**TANKJET 21400A TANK CLEANING NOZZLE**

Model*	–	Bearings and Races Material Code**	–	Capacity Size	–	Body Material Code**
21400A	–	316SS	–	18	–	316SS

\*Add B prior to the nozzle type for BSPT connections.  
\*\*Material: Specify 316SS for Stainless Steel Type 316 (DIN 1.4571).





TankJet 21400A tank cleaning nozzle

**R**  
RINSING

---

**SPRAY COVERAGE**  
360°  

---

**MOUNTING OPTIONS**  
Vertical  

**DIMENSIONS AND WEIGHTS**

Model	L in. (mm)	W in. (mm)	A in. (mm)	Hex. in. (mm)	Min. Tank Opening in. (mm)	Weight lbs. (kg)
21400A	5.28 (134)	1.75 (44.5)	4.39 (111.5)	1.625 (34.9)	2.0 (50.8)	1.5 (0.68)

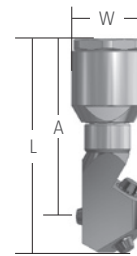

**TANKJET VSM TANK CLEANING NOZZLE  
FEATURES AND BENEFITS**

- Lightweight stationary nozzles are ideal for low pressure rinsing of small vessels
- 240° spray coverage via 40 spray orifices
- Nozzles offer excellent chemical resistance and, with no moving parts, are suitable for clean-in-place (CIP) applications

For lances, mounting kits, adapters and more, see page G6

TankJet VSM tank cleaning nozzle

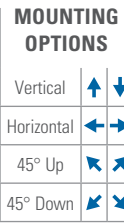
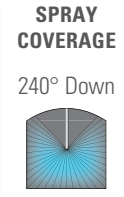

**IDEAL FOR CLEANING:**

- Chemical containers
- Pharmaceutical vats

**SPECIFICATIONS**

TankJet VSM Tank Cleaning Nozzle	
Max. tank diameter:	5 ft. (1.5 m)
Operating principle:	Fixed stationary
Flow rate:	2.7 to 72 gpm (10.4 to 269 lpm)
Operating pressure:	10 to 150 psi (0.7 to 10.3 bar)
Max. temperature:	200°F (93°C)
Materials:	Nylon
Inlet connection:	1/2" or 3/4" NPT or BSPT (F)
Optional accessories:	Strainers, recommended mesh size: 50 (297 micron) See page G2

**DIMENSIONS AND WEIGHTS**

Model	Inlet Conn. Size in.	L in. (mm)	W in. (mm)	A in. (mm)	Min. Tank Opening in. (mm)	Weight oz. (kg)
VSM	1/2	1.69 (45)	0.56 (15)	1.0 (26)	2.0 (50)	3.0 (0.08)
	3/4	2.44 (62)	.75 (20)	1.5 (40)		8.0 (0.23)

**PERFORMANCE DATA**

Model	Inlet Conn. in.	Capacity Size	Max. Free Passage in. (mm)	Liquid Flow Capacity gpm (lpm)							
				10 psi (0.7 bar)	20 psi (1.4 bar)	40 psi (2.8 bar)	60 psi (4.1 bar)	80 psi (5.5 bar)	100 psi (6.9 bar)	130 psi (9.0 bar)	150 psi (10.3 bar)
VSM	1/2	28	0.031 (0.8)	2.7 (10.4)	3.9 (15.3)	5.5 (22)	6.7 (25)	7.8 (28)	8.7 (33)	9.9 (38)	10.6 (40)
	1/2	44	0.039 (1.0)	4.3 (16.3)	6.1 (24)	8.6 (34)	10.6 (39)	12.2 (44)	13.7 (52)	15.6 (59)	16.7 (62)
	1/2	90	0.059 (1.5)	8.8 (33)	12.5 (49)	17.7 (70)	22 (81)	25 (90)	28 (107)	32 (121)	34 (127)
	3/4			140	0.077 (1.95)	13.7 (52)	19.4 (77)	28 (108)	34 (125)	39 (140)	43 (166)
	1/2	190	0.091 (2.3)	18.6 (71)	26 (104)	37 (147)	46 (170)	53 (190)	59 (225)	67 (254)	72 (269)
	3/4										

**ORDERING INFORMATION**

**TANKJET VSM TANK CLEANING NOZZLE**

Model\* — Inlet Conn. Size — Capacity Size

EXAMPLE: **VSM** — **3/4** — **140**

\*Add B prior to the model type for BSPT connections.



**TANKJET 30473 TANK CLEANING NOZZLE FEATURES AND BENEFITS**

- Ideal for rinsing small containers, nozzles fit into tank openings as small as 1 in. (25 mm)
- The force of the cleaning liquid passing through lightweight miniature nozzle provides rotation - no motor required
- Rotating spray head can be easily removed from the body for inspection and maintenance
- Long-wearing material resists aggressive cleaning liquids

**SPECIFICATIONS**

TankJet 30473 Tank Cleaning Nozzle	
Max. tank diameter:	3 ft. (0.9 m)
Operating principle:	Fluid-driven reactionary force
Flow rate:	2.1 to 4.5 gpm (7.8 to 18.0 lpm)
Operating pressure:	10 to 50 psi (0.7 to 3.4 bar)
Max. temperature:	200°F (93°C)
Materials:	1/4" inlet – PTFE 3/8" and 1/2" butt weld (BW) inlet – 316L stainless steel stem with PTFE saucer
Inlet connection:	1/4" and 3/8" NPT or BSPT (M) 1/2" butt weld
Optional accessories:	Strainers, recommended mesh size: 200 (74 micron) See page G2

**IDEAL FOR CLEANING:**

- Chemical containers
- Ducts
- Cylinders
- Pipes

**PERFORMANCE DATA**

Model	Capacity, gpm (lpm)				
	10 psi (0.7 bar)	20 psi (1.4 bar)	30 psi (2.1 bar)	40 psi (2.8 bar)	50 psi (3.4 bar)
30473	2.1 (7.8)	2.9 (11.3)	3.5 (13.0)	4.0 (15.0)	4.5 (18.0)

**ORDERING INFORMATION**

**TANKJET 30473 TANK CLEANING NOZZLE**

Model	Spray Coverage	Inlet Conn. Size*	Material Code
30473	E	1/4	TEF

\*Add B prior to the inlet connection for BSPT connections. Specify BW for butt weld.

TankJet 30473 tank cleaning nozzle



**MOUNTING OPTIONS**

Vertical	↑	↓
Horizontal	←	→
45° Up	↖	↗
45° Down	↘	↙

**R**  
RINSING

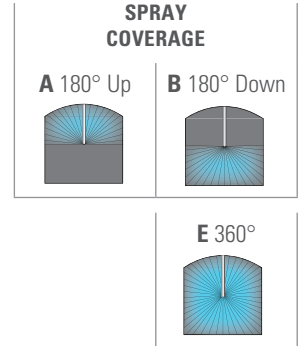

**DIMENSIONS AND WEIGHTS**

Nozzle	Inlet Conn. in.	L in. (mm)	W in. (mm)	Min. Tank Opening in. (mm)	Weight oz. (kg)
30473	1/4	1.75 (44.4)	.87 (22)	1 (25)	0.5 (0.02)
30473	3/8	1.90 (48.3)	.87 (22)		1.7 (0.05)
30473	1/2, butt weld (BW)	1.90 (48.3)	.87 (22)		1.0 (0.03)

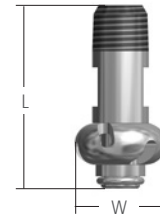

**TANKJET 23240 TANK CLEANING NOZZLE  
FEATURES AND BENEFITS**

- Compact, fluid-driven, rotating nozzles efficiently rinse vessels
- Two flat sprays produce the self-rotating force and side sprays; an optional third spray at the end of the nozzle, provides nearly full spherical coverage
- Long-wearing materials extend service life and enable operation at high temperatures
- Available in electro-polish finish or stainless steel
- Wall mount options available

**SPECIFICATIONS**

TankJet 23240 Tank Cleaning Nozzle	
Max. tank diameter:	3 ft. (0.9 m)
Operating principle:	Fluid-driven reactionary force
Flow rate:	3.5 to 22 gpm (14.0 to 79 lpm)
Operating pressure:	20 to 200 psi (1.4 to 13.8 bar)
Max. temperature:	350°F (177°C)
Materials:	316 stainless steel, hardened stainless steel and 50% stainless steel filled PTFE (316SS)
Inlet connection:	1/2" NPT or BSPT (F)
Optional accessories:	Strainers, recommended mesh size: 200 (74 microns) See page G2

**IDEAL FOR CLEANING:**

- Barrels
- Cylinders
- Ducts
- Kegs
- Pipes
- Tube



**SPRAY COVERAGE**

2 Side Spray



3 360°



**MOUNTING OPTIONS**

Vertical



TankJet 23240-3 tank cleaning nozzle

TankJet 23240-2 tank cleaning nozzle

**DIMENSIONS AND WEIGHTS**

Model	L in. (mm)	W in. (mm)	Min. Tank Opening in. (mm)	Weight oz. (kg)
23240	3.5 (89)	1 (25.4)	1.03 (26)	8.0 (0.23)

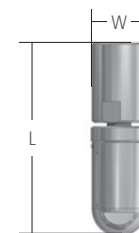

**PERFORMANCE DATA**

Model	Coverage Type	Capacity Size	Liquid Flow Capacity gpm (lpm)							
			20 psi (1.4 bar)	40 psi (2.8 bar)	60 psi (4.1 bar)	80 psi (5.5 bar)	100 psi (6.9 bar)	120 psi (8.3 bar)	150 psi (10.3 bar)	200 psi (13.8 bar)
23240	2	5	3.5 (14.0)	5.0 (19.7)	6.1 (23)	7.1 (25)	7.9 (28)	8.7 (32)	9.7 (36)	11.2 (39)
		8	5.7 (22)	8.0 (32)	9.8 (36)	11.3 (41)	12.6 (45)	13.9 (52)	15.5 (58)	17.9 (63)
	3	5.7	4.0 (15.9)	5.7 (22)	7.0 (26)	8.1 (29)	9.0 (32)	9.9 (37)	11.0 (41)	12.7 (45)
		7	4.9 (19.5)	7.0 (28)	8.6 (32)	9.9 (36)	11.1 (39)	12.1 (45)	13.6 (50)	15.7 (55)
		10	7.1 (28)	10.0 (39)	12.2 (46)	14.1 (51)	15.8 (56)	17.3 (64)	19.4 (72)	22 (79)

**ORDERING INFORMATION**

**TANKJET 23240 TANK CLEANING NOZZLE**

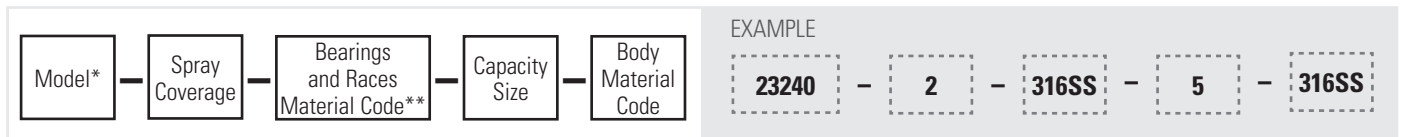

\*Add B prior to the Model type for BSPT connections.

\*\*All bearings and races specify 316SS for Stainless Steel Type 316 (DIN 1.4571).



## Transit Agency Saves More Than \$22,000 Annually with Mobile Unit for Drum Cleaning

### PROBLEM:

A large metropolitan transit agency used an outside service firm to collect empty 55-gallon drums for recycling that contained oil, transmission fluid or other automotive fluid residue. The service firm charged a substantial fee for cleaning the drums, which was required prior to re-use or disposal. The transit agency has approximately 80 drums in use and the ongoing cleaning fees strained the operating budget.

### SOLUTION:

TankJet® M60 mobile tank cleaners are now used to clean the agency's 55-gallon drums. The tank cleaner is installed on a mobile cart that can be moved easily from drum to drum. Equipped with nozzles that provide rotating solid stream sprays in multiple axes, the tank cleaner provides quick and efficient cleaning. Drums are cleaned in less than four minutes. A heated pressure washer powers the TankJet M60 mobile tank cleaner.

### RESULTS:

The transit agency is now using TankJet M60 mobile tank cleaners in multiple locations and has eliminated the substantial fees charged by the outside service firm. The agency reports savings of more than US\$22,000 annually and a payback period of just over three months per tank cleaner.

Call your local spray expert to explore your tank cleaning options.

TankJet M60 mobile tank cleaner, see page F4

