

ECO NO.	DATE	REVISION & DESCRIPTION	REVWED	CHECKED

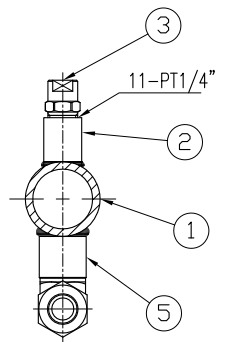

SECTION "A"-"A"
(SCALE 3:1)

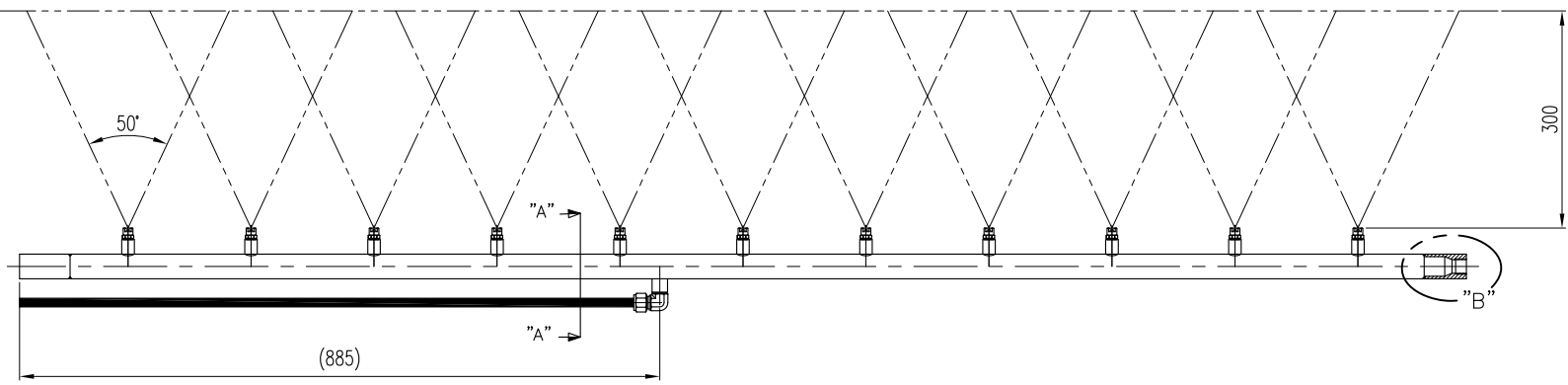
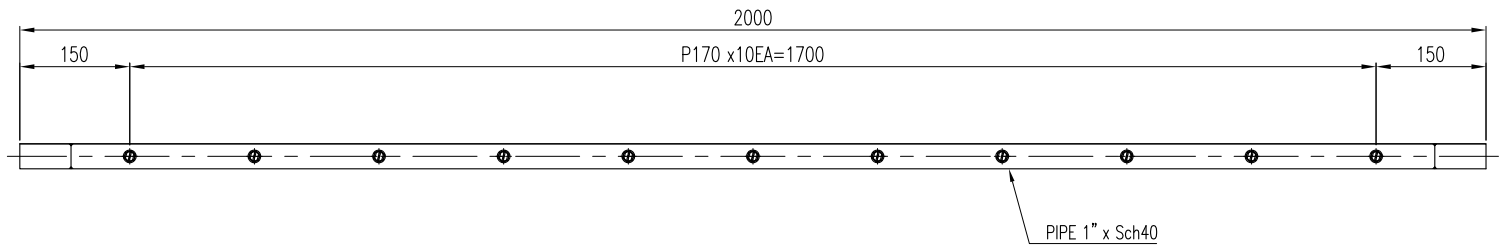
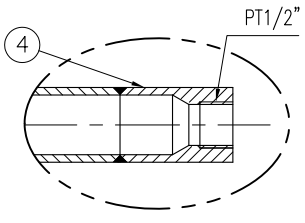

DETAIL "B"
(SCALE 3:1)

5	PIPE BUTT WEID ELBOW(UWBE-0808P)	SUS304	1	
4	NIPPLE	SUS304	2	
3	NOZZLE(KB1/4MEG-SS5004)	SUS303	11	
2	SOCKET	SUS304	11	
1	PIPE(1" x SCH 40)	SUS304	1	
ITEM	COMPONENT	MATERIAL	Q'TY	REMARKS

DESC.	KHD163554-304SS WET 유 SPRAY HEADER	CUSTOMER :	광)포스코 2냉연 2CAL #1CAL (상,하부)	
APP BY.	CH BY.	DES BY.	PRODUCT NAME :	
J.M.LEE	J.H.YOU	Y.M.KO	-	

	Spraying Systems Co., Korea Export in Spray Technology	SCALE :	CREATE DATE :
		1:10	2016.11.29
		THIRD ANGLE	DWG. NO. :
			56163-554-C1

지시의 용접치수	절삭가공치수의 지시와 일반치수 허용차 (KS B ISO2768-1 중급)					
	구 분	0.5 이상 3 이하	3 을초과 6 이하	6 을초과 30 이하	30 을초과 120 이하	120 을초과 400 이하
	허용 차	±0.1	±0.1	±0.2	±0.3	±0.5
지시와 모서리부분	SURFACE ROUGHNESS (KS B 0617)					
	다듬질기호	~	▽	▽▽	▽▽▽	▽▽▽▽
	Rmax		100S	25S	6.3S	0.8S

PRESSURE	SPRAY ANGLE (±7°)
	(XXX)~(XXX)~(XXX)
	(XXX)~(XXX)~(XXX)
(XXX) (kg/cm ²)	CAPACITY (ℓ/min ±7%)

ECO NO.	DATE	REVISION & DESCRIPTION	REVWED	CHECKED

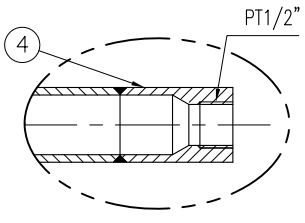
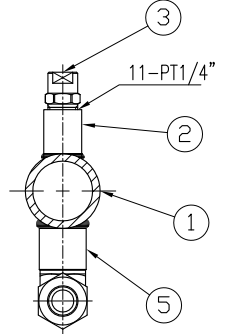
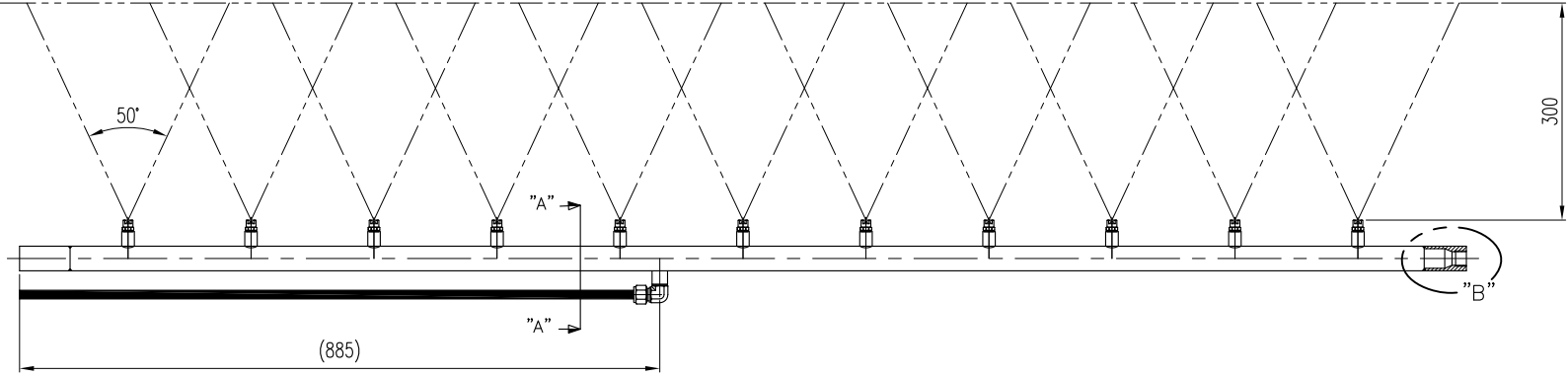
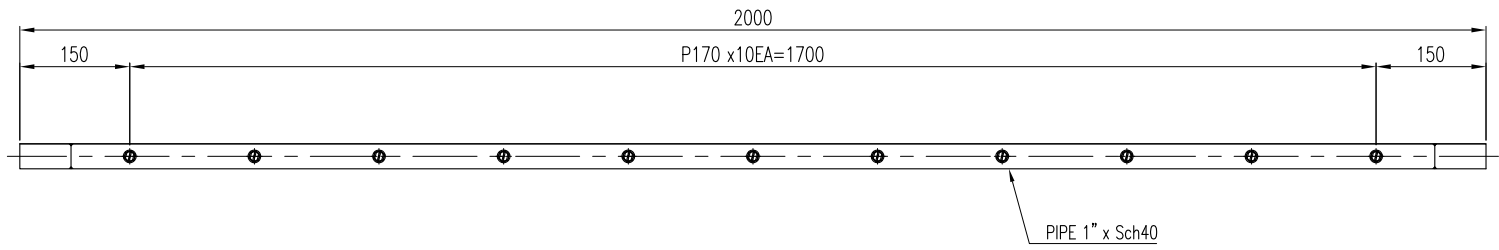

5	PIPE BUTT WEID ELBOW(UWBE-0808P)	SUS304	1	
4	NIPPLE	SUS304	2	
3	NOZZLE(KB1/4MEG-SS5004)	SUS303	11	
2	SOCKET	SUS304	11	
1	PIPE(1" x SCH 40)	SUS304	1	
ITEM	COMPONENT	MATERIAL	Q'TY	REMARKS

DESC.	KHD163554-304SS WET 유 SPRAY HEADER	CUSTOMER : 광)포스코 2냉연 2CAL #2CAL (상,하부)
APP BY.	CH BY.	DES BY.
J.M.LEE	J.H.YOU	Y.M.KO
PRODUCT NAME :		-

지시의 용접치수 절삭가공치수의 지시와 일반치수 허용차 (KS B ISO2768-1 중급)

	구 분	0.5 이상 3 이하	3 을초과 6 이하	6 을초과 30 이하	30 을초과 120 이하	120 을초과 400 이하
	허용 차	±0.1	±0.1	±0.2	±0.3	±0.5
지시외 모서리부분	SURFACE ROUGHNESS (KS B 0617)					
C= R=	다듬질기호	~	▽	▽▽	▽▽▽	▽▽▽▽
	Rmax		100S	25S	6.3S	0.8S

PRESSURE (XXX) (kg/cm ²)	SPECIFICATION
	SPRAY ANGLE (±7°) (XXX)~(XXX)~(XXX)
	(XXX)~(XXX)~(XXX)
	CAPACITY (ℓ/min ±7%)

Spraying Systems Co., Korea
Export in Spray Technology

SCALE :	CREATE DATE :
1:10	2016.11.29
THIRD ANGLE	DWG. NO. :
	56163-554-C1

ECO NO.	DATE	REVISION & DESCRIPTION	REVISED	CHECKED

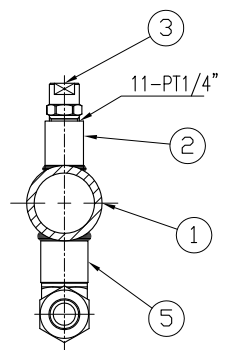
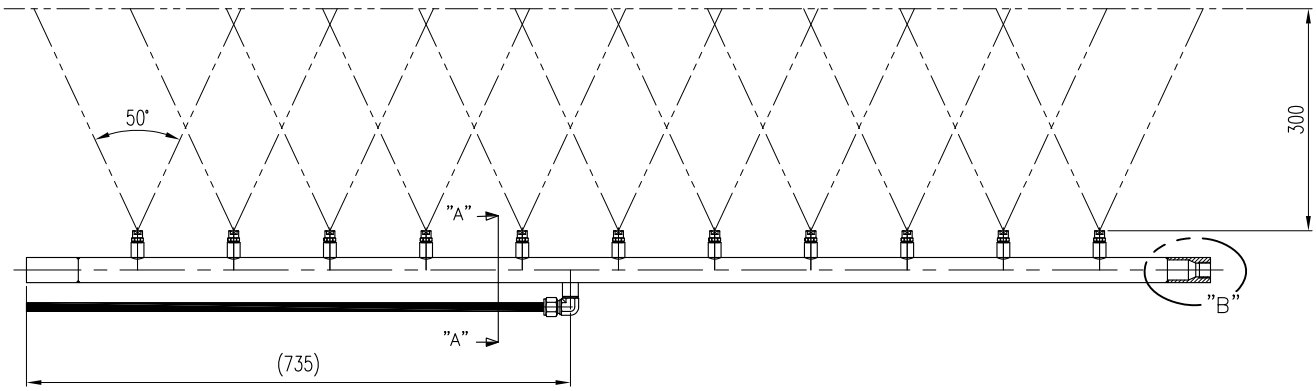
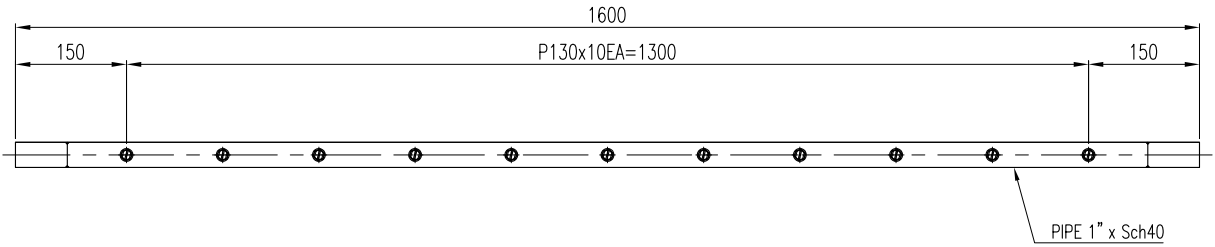

SECTION "A"-"A"
(SCALE 3:1)

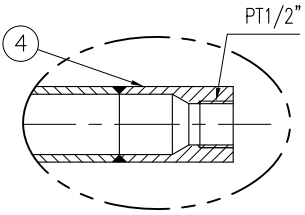

DETAIL "B"
(SCALE 3:1)

5	PIPE BUTT WEID ELBOW(UWBE-0808P)	SUS304	1	
4	NIPPLE	SUS304	2	
3	NOZZLE(KB1/4MEG-SS5004)	SUS303	11	
2	SOCKET	SUS304	11	
1	PIPE(1" x SCH 40)	SUS304	1	
ITEM	COMPONENT	MATERIAL	Q'TY	REMARKS

DESC.	KHD163555-304SS WET 유 SPRAY HEADER	CUSTOMER :	광)포스코 3냉연 3CAL #2CAL
APP BY.	CH BY.	DES BY.	PRODUCT NAME :
J.M.LEE	J.H.YOU	Y.M.KO	-

지시외 용접치수	철삭가공치수의 지시외 일반치수 허용차 (KS B ISO2768-1 중급)					
	구 분	0.5 이상 3 이하	3 을초과 6 이하	6 을초과 30 이하	30 을초과 120 이하	120 을초과 400 이하
	허용 차	±0.1	±0.1	±0.2	±0.3	±0.5
지시외 모서리부분	SURFACE ROUGHNESS (KS B 0617)					
C= R=	다듬질기호	▽	▽▽	▽▽▽	▽▽▽▽	
	Rmax	100S	25S	6.3S	0.8S	

SPECIFICATION	
PRESSURE (XXX) (kg/cm ²)	SPRAY ANGLE (±7°) (XXX)~(XXX)~(XXX)
	(XXX)~(XXX)~(XXX) CAPACITY (ℓ/min ±7%)

Spraying Systems Co., Korea
Export in Spray Technology

SCALE :	CREATE DATE :
1:10	2016.11.08
THIRD ANGLE	DWG. NO. :
	56163-555-C1

ECO NO.	DATE	REVISION & DESCRIPTION	REVWED	CHECKED

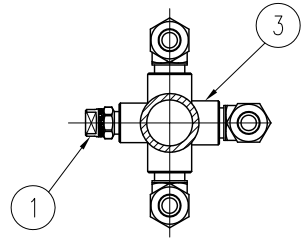
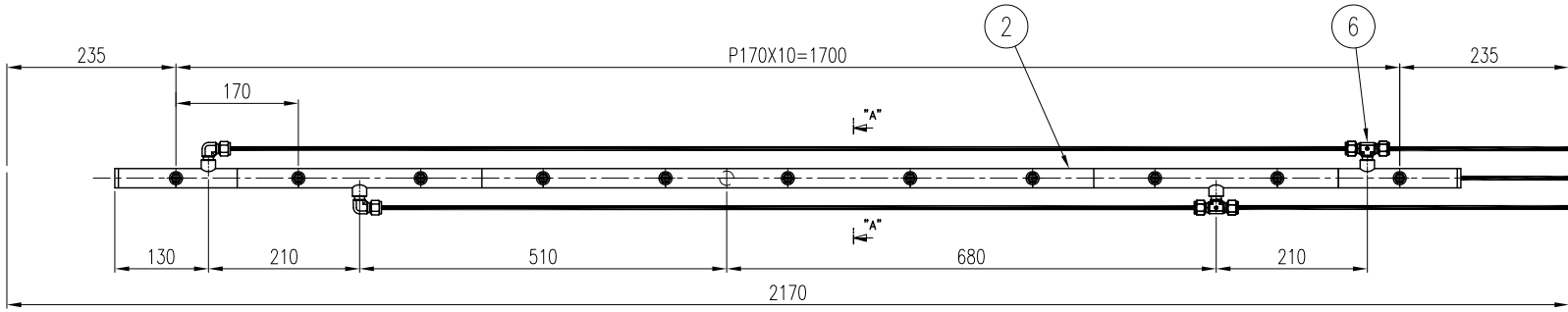
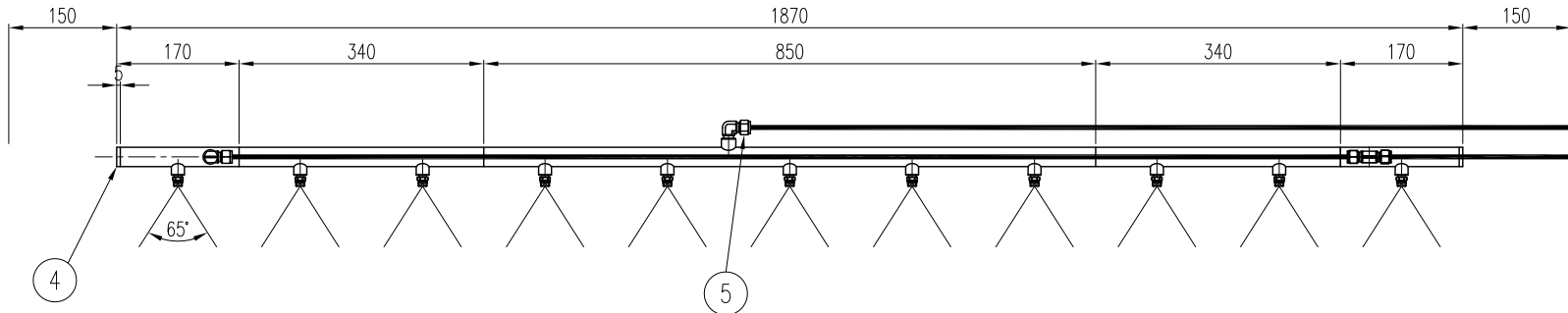

SECTION A'-A'
SCALE 3:1

6	MALE BRANCH TEE (UMBT-0604N)	SUS304	2	UNILOK PUR
5	MALE ELBOW(UWBE-0604P)	SUS304	3	UNILOK PUR
4	END PLATE	SUS304	6	
3	SOCKET	SUS304	16	
2	PIPE(3/4"xSCH40)	SUS304	1	
1	NOZZLE(B1/4MEG-SS 6502)	SUS303	11	
ITEM	COMPONENT	MATERIAL	Q'TY	REMARKS

DESC.	KHD163537-SS WET유 SPRAY HEADER	CUSTOMER : 광)포스코 4냉연 4CAL 2-1
-------	-----------------------------------	-------------------------------------

APP BY.	CH BY.	DES BY.	PRODUCT NAME :
J.M.LEE	J.H.YOU	S.C.PARK	

	SCALE : 1:1	CREATE DATE : 2016.10.07
	THIRD ANGLE 	DWG. NO. : 56163-537-C1

지시외 용접치수 절삭가공치수의 지시외 일반치수 허용차 (KS B ISO2768-1 중급)

	구 분	0.5 이상 3 이하	3 을초과 6 이하	6 을초과 30 이하	30 을초과 120 이하	120 을초과 400 이하
	허용 차	±0.1	±0.1	±0.2	±0.3	±0.5

지시외 모서리부분	SURFACE ROUGHNESS (KS B 0617)					
C=	다듬질기호	~	▽	▽▽	▽▽▽	▽▽▽▽
R=	Rmax		100S	25S	6.3S	0.8S

SPECIFICATION

PRESSURE (XXX) (kg/cm ²)	SPRAY ANGLE (±7°)	(XXX)~(XXX)~(XXX)
	(XXX)~(XXX)~(XXX)	
	CAPACITY (ℓ/min ±7%)	

ECO NO.	DATE	REVISION & DESCRIPTION	REVWED	CHECKED
△				
△				

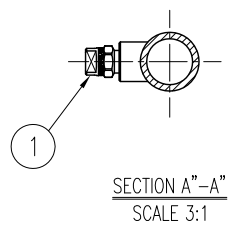
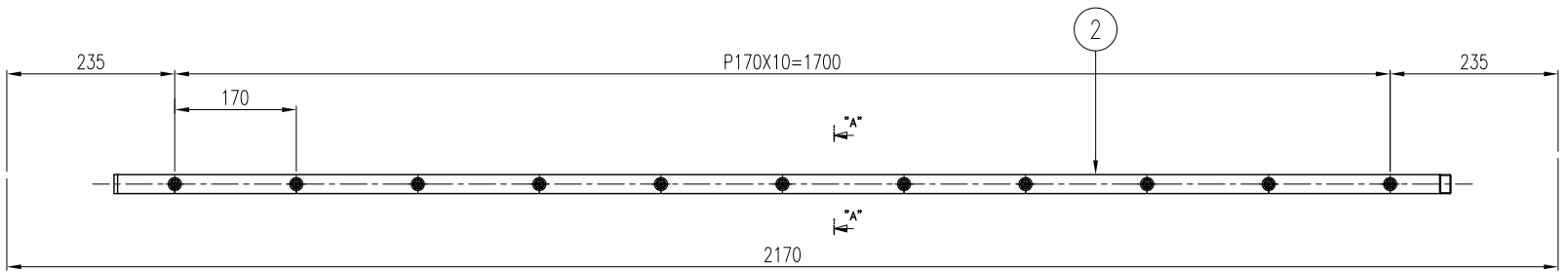
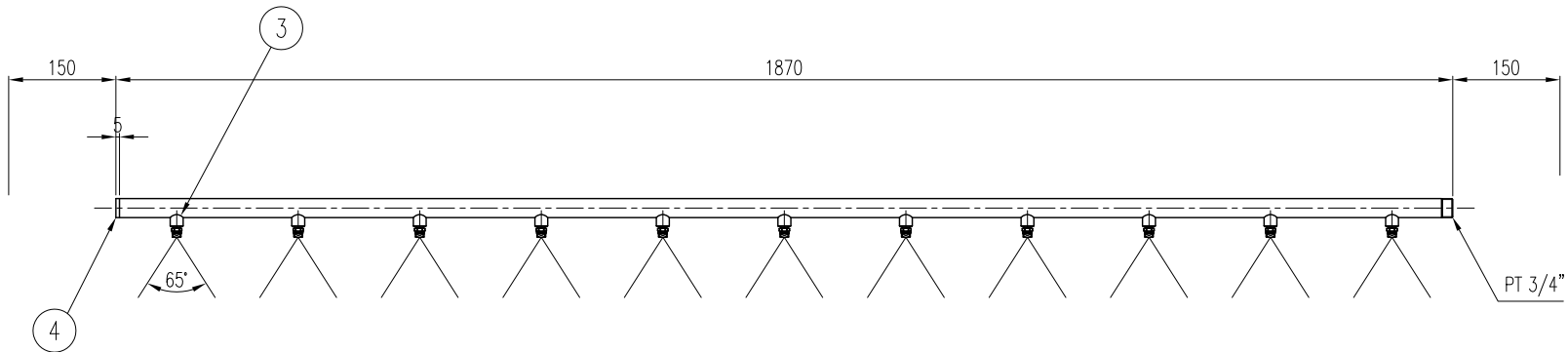

4	END PLATE	SUS304	2	
3	SOCKET	SUS304	11	
2	PIPE(3/4"xSCH40)	SUS304	1	
1	NOZZLE(B1/4MEG-SS 6502)	SUS303	11	
ITEM	COMPONENT	MATERIAL	Q'TY	REMARKS

DESC.	KHD163536-SS WET유 SPRAY HEADER	CUSTOMER : 광) 포스코 4냉연 4CAL 2-2
-------	-----------------------------------	--------------------------------------

APP BY.	CH BY.	DES BY.	PRODUCT NAME :
J.M.LEE	J.H.YOU	S.C.PARK	

	SCALE : 1:1	CREATE DATE : 2016.10.07
	THIRD ANGLE 	DWG. NO. : 56163-536-C1

지시의 용접치수	절삭가공치수의 지시와 일반치수 허용차 (KS B ISO2768-1 중급)					
	구 분	0.5 이상 3 이하	3 을초과 6 이하	6 을초과 30 이하	30 을초과 120 이하	120 을초과 400 이하
	허용 차	±0.1	±0.1	±0.2	±0.3	±0.5

지시와 모서리부분	SURFACE ROUGHNESS (KS B 0617)					
C= R=	다듬질기호	~	▽	▽▽	▽▽▽	▽▽▽▽
	Rmax		100S	25S	6.3S	0.8S

SPECIFICATION	
PRESSURE (XXX) (kg/cm ²)	SPRAY ANGLE (±7°) (XXX)~(XXX)~(XXX)
	(XXX)~(XXX)~(XXX)
	CAPACITY (ℓ/min ±7%)