



PRECISION SPRAY INJECTORS

OPTIMIZE PERFORMANCE WITH INJECTORS
BUILT FOR YOUR EXACT PROCESS CONDITIONS



Spraying Systems Co.
Experts in Spray Technology





BUILT-TO-ORDER INJECTOR SOLUTIONS TO OPTIMIZE PROCESS PERFORMANCE

If your operation requires the addition of a liquid or gas to a process stream, we are uniquely qualified to supply the delivery equipment. Commonly referred to as lances, quills, spray injectors and guns, this equipment is instrumental in achieving the desired cooling, mixing, quenching, washing, humidifying, gas conditioning and/or chemical reaction. A breakdown in any of these processes can have costly and sometimes dangerous outcomes, such as damage to downstream equipment, wall wetting, refractory cracking, duct corrosion, premature furnace/tower failure and unscheduled outages.

Partnering with Spraying Systems Co. ensures your injectors deliver the precise performance needed, withstand harsh operating environments and provide the required service life. We've successfully applied more than 80 years of spray technology expertise to injector design, validation and fabrication for engineering firms and processors around the world. We'd like to do the same for you. You'll see evidence of our proven track record in the pages that follow.





TABLE OF CONTENTS

	PAGE
OVERVIEW	4-5
INJECTOR SOLUTIONS FOR REFINERIES	6-8
INJECTOR SOLUTIONS FOR PETROCHEMICAL/CHEMICAL PROCESSORS	9
INJECTOR SOLUTIONS FOR POLLUTION CONTROL	10
INJECTOR SOLUTIONS FOR POWER PLANTS	11
INJECTOR SOLUTIONS FOR CEMENT PLANTS	12
INJECTOR SOLUTIONS FOR STEEL MILLS	13
SELECTION & SPECIFICATION TECHNICAL REFERENCE	14
INJECTOR DESIGN & FABRICATION SERVICES OVERVIEW	15



CHOOSING THE RIGHT PARTNER FOR YOUR PROJECT

If you think there's not much difference between a pipe with holes and a spray injector with a nozzle, we'd like to challenge your thinking. Similarly, if you are using a local fabricator or making your own sulfur guns, spray lances or other fluid delivery devices, process performance may be compromised and you may not realize it.

The importance of injection equipment is not widely understood because it's impossible to see what is going on inside a process vessel, furnace or duct. The performance of the injection equipment typically isn't evaluated unless there are obvious problems, such as damage to downstream equipment or process failure, or the equipment has been in use for an extended period of time. Given all the unknowns, doesn't it make sense to work with an expert in spray injection equipment? We have that expertise, and here's how you can take advantage of it.

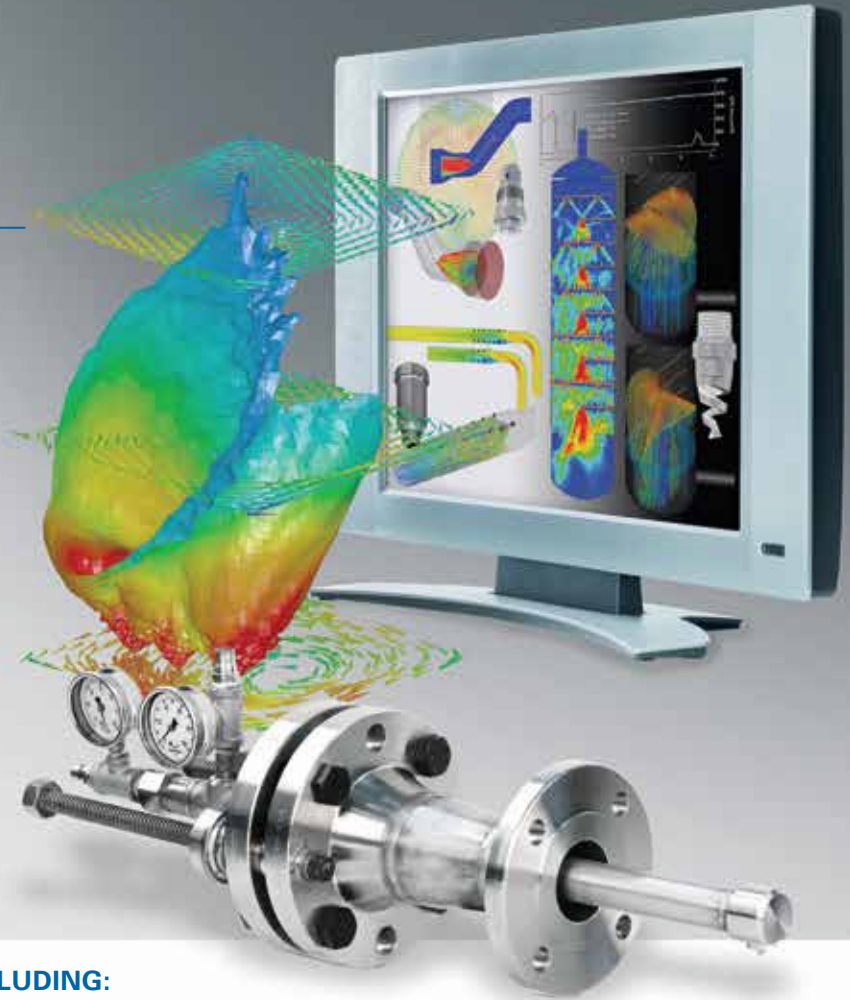

WE PROVIDE A WIDE RANGE OF SERVICES INCLUDING:

DESIGN AND VALIDATION

Injector design requires detailed information about process conditions:

- Location/process unit where the injector will be used
- Description of how the injector will be used
- Injecting stream and receiving stream process information
- Code requirements
- Testing and quality control requirements

The importance of the injector in the overall process will determine the tools used during the design process. In some cases, our drop size data library and proprietary gas cooling calculation software can determine the size/type of nozzle required, injector placement in the vessel and spray direction. In other cases, Fluid Structure Interaction (FSI) is used to evaluate mechanical stresses, such as pressure, vibration and vortex shedding on the injector. Computational Fluid Dynamics (CFD) modeling may be used to determine how the injected fluid or gas interacts with the receiving stream to validate performance.

FABRICATION/TESTING SERVICES

We have decades of experience manufacturing injectors. Our staff includes engineering specialists and certified welders.

Other credentials include:

- Manufacturing code compliance: ASME® Boiler & Pressure Vessel Code (BPVC); ASME U-Stamp Vessel Manufacturing; ASME B31.1; ASME B31.3 and ASME BPVC Section IX
- Testing/validation: Hydrostatic testing (LT), material traceability (MTR), liquid penetrant examination (PT), radiographic examination (RT), visual testing (VT), weld maps and ferrite weld testing and ultrasonic examination (UT)
- Certifications: ISO 9001-2018 and ISO 14001-2018; ASME BPVC Section VIII; Canadian Registration Number (CRN) and Pressure Equipment Directive (PED)





INJECTION EQUIPMENT OVERVIEW

- Additive injectors
- Catalyst reformer gas cooling injectors
- Chloride injectors
- Coker off-gas cooling injectors
- Defoaming injectors
- Desuperheating injectors
- Distillation column overhead water wash injectors
- FCCU overhead water wash injectors
- FCCU feed injectors
- Fractionator water wash injectors
- Heat exchanger injectors
- Mix temperature control injectors
- Quills
- Regenerator bypass injectors
- SCR NOx control injectors
- Slurry backflush injectors
- SNCR NOx control injectors
- Spool pieces
- Steam quench injectors
- Torch oil injectors
- Vapor quench injectors

FLEXIBILITY IN PROJECT SCOPE

If you know exactly what your application requires, we will fabricate injectors based on your specifications. If your application is new or you're interested in improving or validating performance, we recommend involving us in the design/specification process.

Here are a few ways we've helped others:

- Added a nozzle to a quill to provide better mixing and spray distribution to minimize corrosion in a water wash application
- Utilized available plant steam instead of compressed air for atomization in gas treatment to reduce cost and advance the customer's sustainability initiative
- Eliminated wall wetting in a gas cooling application by equipping the injector with nozzles that produce the proper drop size for efficient cooling and complete evaporation
- Changed spray direction from co-current to counter-current to improve cooling efficiency and achieve a significant reduction in gas temperature for a power generation company
- Reduced maintenance time by two days by using retractable injectors in a cooling operation for a refinery

Many of our customers involve us at the beginning of projects for design assistance and/or validation using our modeling services.

On the following pages, you'll find a large selection of injection equipment we've made for customers with a wide range of applications in many different industries. **This will give you an overview of our capabilities. To learn more about our injector design and fabrication services, contact your local sales engineer or visit spray.com/injectors.**



UNIQUE INJECTOR SOLUTIONS FOR REFINERIES

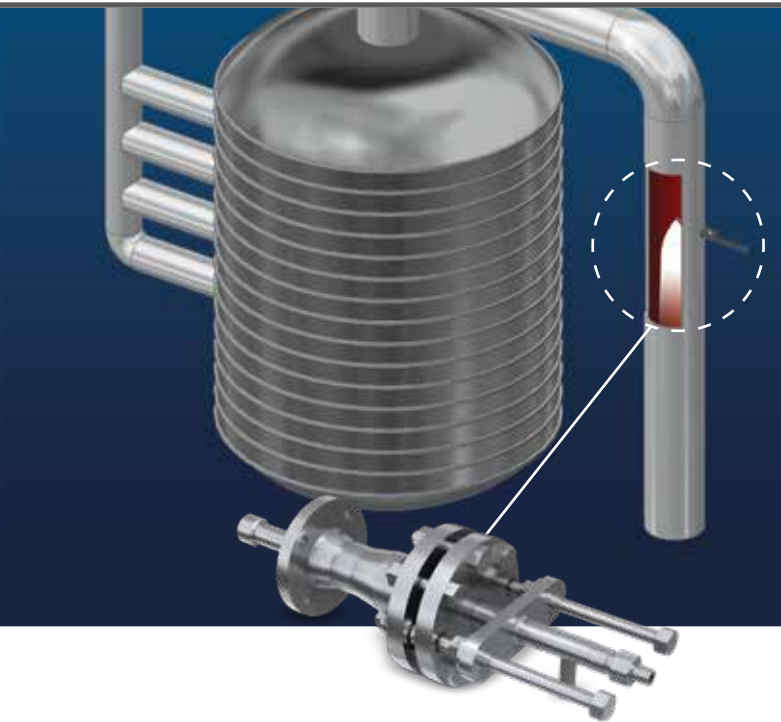

COOLING WITH LIQUID NITROGEN

Problems: Safety Concerns and Downtime

Catalyst in the reactor needed to be replaced every 24 months. The reactor was turned off to begin the cooling process. Once the temperature decreased to a pre-determined level, a pipe fitter removed a blind flange and inserted an injection quill to spray liquid nitrogen into the reactor to increase the cooling rate. The risk of worker exposure to high-temperature hydrocarbons was a significant safety concern, and the downtime resulted in lost revenue for the refinery.

Solution: Retractable Injection Quills

Mechanical retractable injection quills eliminated the need for workers to manually insert spray quills, so the cooling process can begin without a partial plant shutdown. In fact, the efficiency and safety of the new retractable injection quills enabled downtime to be reduced by two days for catalyst replacement – a savings of \$2,000,000 for the refinery.

OVERVIEW:

- Modeling determined the number and placement of the injectors and spray performance for optimum cooling
- Manufactured to ASME® B31.3 Process Piping Code
- Positive material identification, radiographic examination of butt welds

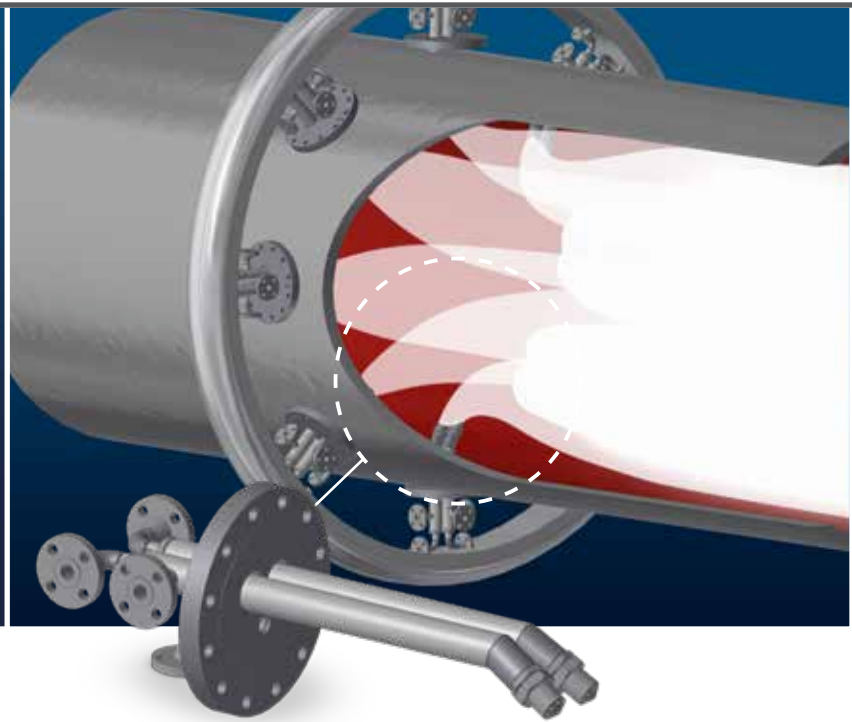

BYPASS DUCT COOLING

Problem: Ensure Adequate Cooling of Gas Prior to Downstream Processes

Waste heat steam generators are widely used to burn off CO from gas prior to downstream processes. In the event of boiler failure or maintenance, the gas is often diverted to a bypass duct for cooling. However, one refinery was struggling to overcome concerns about damage to the refractory lining from incomplete evaporation and the overall cost of the cooling system.

Solution: Steam Injectors

Eight spray injectors, equipped with steam-compatible FloMax® nozzles that deliver the precise drop size required to ensure 100% evaporation, were placed at compound angles in the process duct. The refractory lining remained dry; the placement of the injectors accommodated an existing catwalk and the number of taps in the duct was minimized. In addition, the use of readily available steam was an economical alternative to costly compressed air.

OVERVIEW:

- Drop size analysis determined the type of nozzle and placement
- Injector design accommodated existing physical structures to minimize renovation to existing equipment
- Reaction-bonded silicon carbide and 316 stainless steel materials used for abrasion resistance





CRUDE OVERHEAD WATER WASH IN DISTILLATION COLUMN

Problem: Fire Caused by Corrosion

A refinery, trying to avoid the expense of a water wash injector, experienced a major fire. Rapid corrosion in an overhead duct in the distillation column resulted in a gas leak. The gas leak was the catalyst of the downstream fire.

Solution: Use of Spray Injector in Overhead Line

Computational Fluid Dynamics (CFD) modeling was used to ensure the injector was positioned properly in the gas stream to optimize spray distribution and interaction with the gas. In addition to injector placement, the modeling determined which nozzle would produce the drop size needed for optimal interaction with the gas stream. The final design was an injector equipped with a FullJet® full cone nozzle spraying co-currently with the gas stream. Since installation, corrosion in the line has been mitigated and the refinery has been fire free.

OVERVIEW:

- Modeling determined the type of nozzle, placement of injector in the gas stream and spray direction
- Manufactured to ASME® B31.3 Process Piping Code
- Visual examination, liquid penetrant examination on butt and fillet welds, radiographic examination on butt welds, hydrostatic testing, hardness testing

QUILL VS. INJECTOR: WHICH WILL YIELD BETTER PERFORMANCE?

In general, you should use an injector unless you don't need any control over spray characteristics, such as flow rate, drop size or spray pattern.

An injector with a spray nozzle provides more efficient mixing and better drop size breakup than a quill and can provide more control over the process.

Injectors cost more than quills. However, given the long service life requirements of injectors and quills – up to five years – the difference in cost is insignificant should a problem occur due to imprecise flow. The cost of unscheduled downtime, damage to downstream equipment or incomplete cooling, washing or chemical reactions will far exceed the cost differential between an injector and a quill.



Spray Quill



Spray Injector

UNIQUE INJECTOR SOLUTIONS FOR REFINERIES

BUILT-TO-SPEC SOLUTIONS FOR REFINERIES



Water Wash Injector



Torch Oil Injector



Naphtha Cracking Injector



**Two-Fluid Retractable Injector
for use with steam**



NOx FloMax® Injector



Hydraulic Injector with Spool

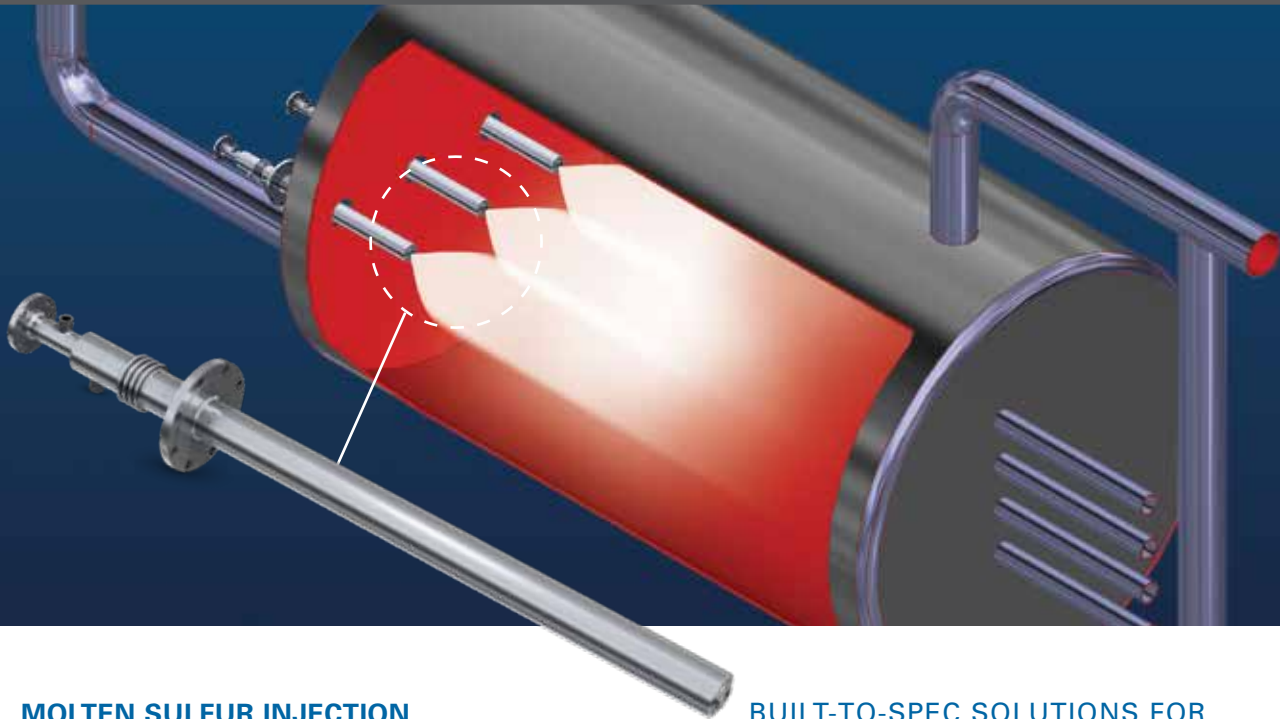

MOLTEN SULFUR INJECTION

Problem: Plugged Nozzles

Lost production time, excess maintenance and safety issues are typical problems sulfur producers experience due to plugged nozzles. These problems have a negative impact on revenue.

Solution: CBA Sulfur Gun

The CBA sulfur gun, with new nozzle design, eliminates plugging and reduces safety issues. In addition, the gun is designed for quick and easy nozzle changeout. As a result, production time is maximized and concerns about worker safety eliminated.

OVERVIEW:

- After an initial trial of one sulfur gun with the new design, the producer quickly retrofitted the entire furnace
- The new guns were designed to fit in the existing space; all inlets, outlets and flange sizes remained the same
- Threaded nozzle for ease of nozzle replacement

BUILT-TO-SPEC SOLUTIONS FOR PETROCHEMICAL/CHEMICAL PROCESSORS

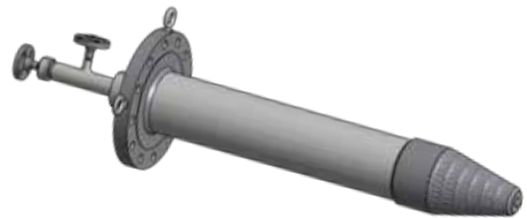

Chemical Injection Injector



Propane Quench Injector



CBA Sulfur Gun

UNIQUE INJECTOR SOLUTIONS FOR POLLUTION CONTROL

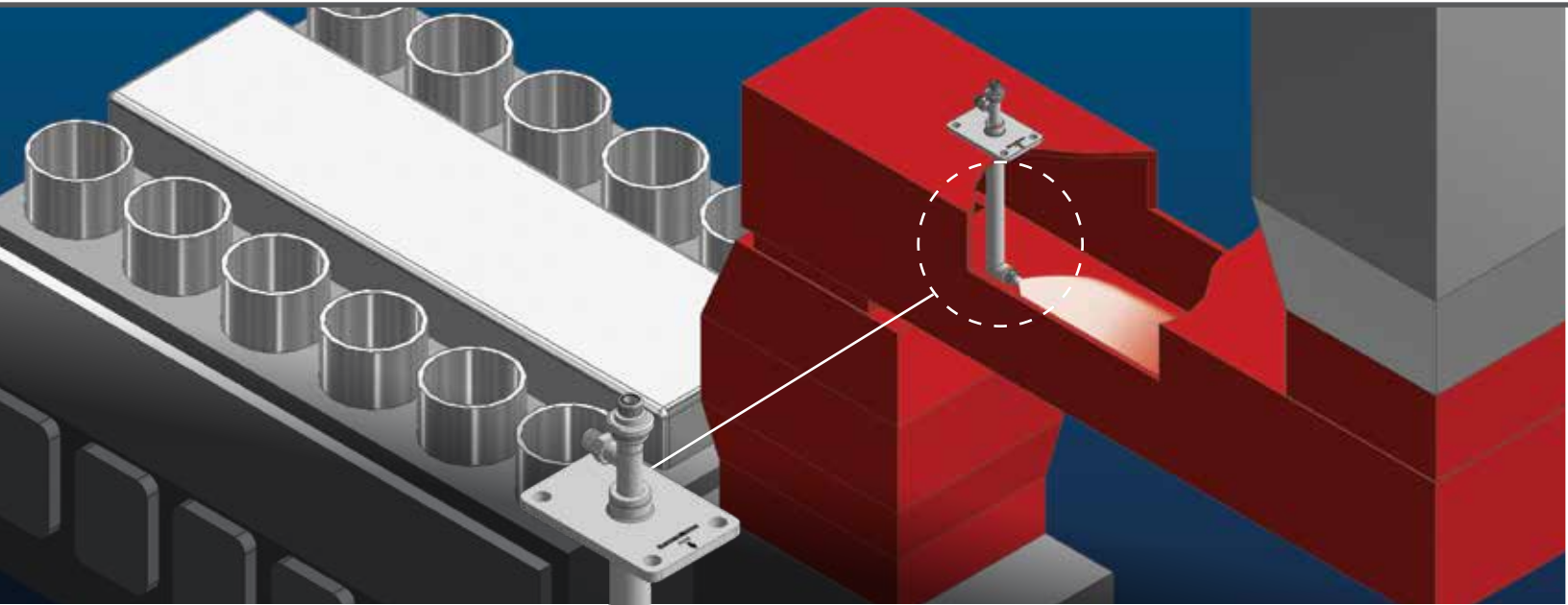

NO_x CONTROL IN DUCT

Problems: Urea Crystallization Causing Injector Clogging and Emission Control Failure

An engine manufacturer was having trouble with high temperature exhaust gas. The urea was crystallizing due to the gas temperature, and the injector was clogging. The SCR process was compromised and ammonia slip was a concern.

Solution: Injector and Nozzle Redesign with Better Insulation and Larger Free Passage

The new injector design reduced the heat transfer from the high temperature exhaust gases and prevented the urea from boiling. The injector profile was also modified to improve downstream gas and fluid mixing. The special nozzle design improved reliability and overall spray performance to increase the efficiency of the NO_x reduction process.

OVERVIEW:

- Wide, open flow passages in nozzle improved overall performance
- Nozzle design based on extensive drop size testing

BUILT-TO-SPEC SOLUTIONS FOR POLLUTION CONTROL



UNIQUE INJECTOR SOLUTIONS FOR POWER PLANTS

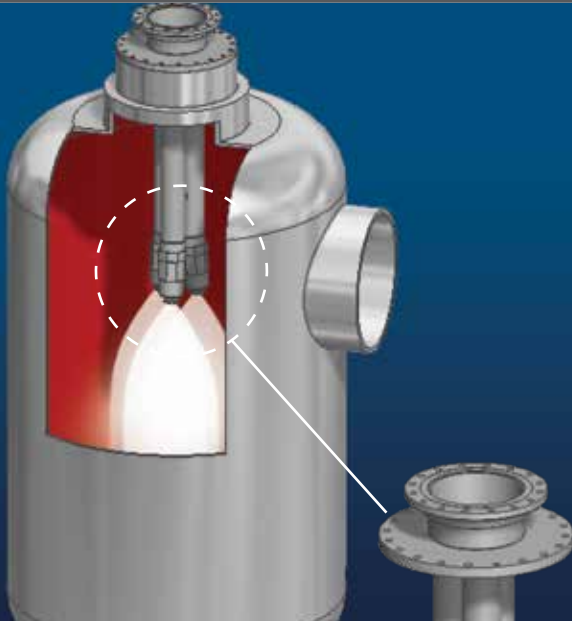

DESUPERHEATING IN CONDENSER

Problem: Inadequate Cooling of Gas from Steam Ejector

Damage to downstream equipment caused by high temperature gas and excess moisture was an ongoing problem for a power plant. A single nozzle injector couldn't achieve the gas temperature reduction required.

Solution: Multi-Nozzle Injector Placed Prior to Gas Outlet

Computational Fluid Dynamics (CFD) modeling was used to confirm the exact temperature reduction for the gas and the proposed solution of a single injector equipped with three FullJet® full cone nozzles. The FullJet nozzles produced small drops that provided better coverage without wall wetting. In addition, the nozzles were positioned to ensure thorough mixing of water with the gas stream. CFD modeling also validated the optimal placement of the injector was right before the outlet to maximize contact with the steam.

OVERVIEW:

- CFD modeling used to determine nozzle type, size and injector placement in gas stream
- Manufactured to ASME® B31.1 Power Piping Code

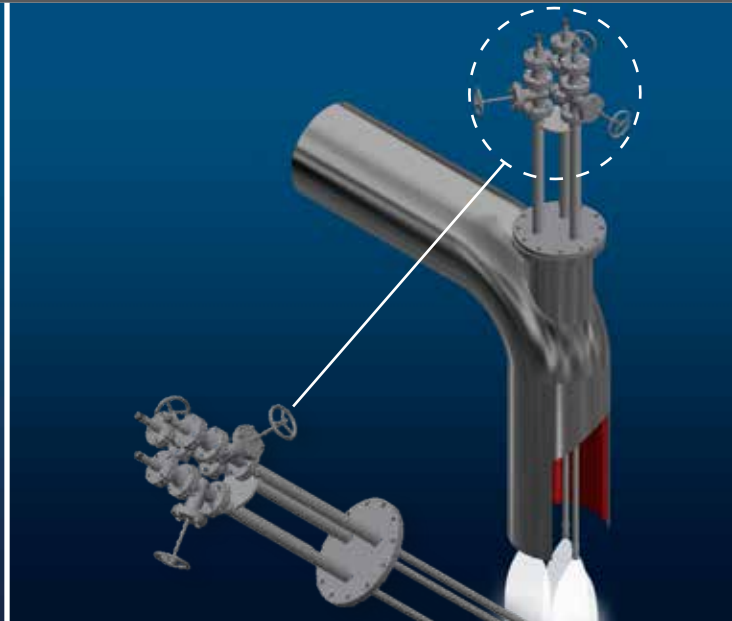

AIR SATURATION IN PROCESS DUCT

Problems: Wall Wetting and Clogging

A power company was using full cone nozzles to saturate air in a process duct. However, the nozzles sprayed inconsistently and wall wetting was a problem as process parameters varied. The full cone nozzles also clogged frequently. Maintenance time was high – both to clean the sludge on the duct walls and unplug the nozzles.

Solution: New Design with Clog-Resistant Nozzles

After reviewing the process conditions, it was determined that extending the length of the three injectors inside the duct would help reduce wall wetting. In addition, isolation valves were added to the injectors, so the flow to each nozzle could be throttled as needed when process conditions changed. Lastly, the injectors were equipped with clog-resistant Maximum Free Passage (MFP) FullJet® full cone nozzles. These design changes proved effective. Both wall wetting and clogging have been eliminated.

OVERVIEW:

- Unique three-in-one injector design accommodates changing process conditions
- Analysis of process conditions determined best placement of nozzles to reduce wall wetting
- Manufactured to ASME B31.1 Power Piping Code



UNIQUE INJECTOR SOLUTIONS FOR CEMENT PLANTS

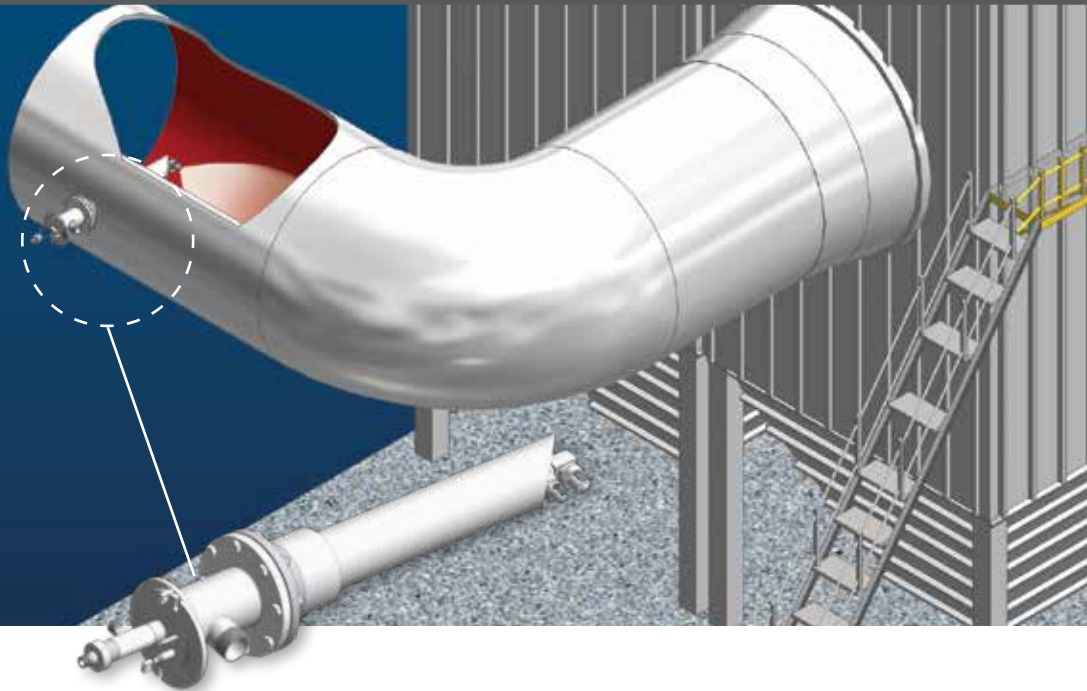

HIGH TURNDOWN GAS COOLING

Problem: Fluctuations in Gas Temperature Prior to Baghouse

Achieving the proper gas temperature for hot gas before it entered the baghouse was a significant challenge for this cement plant. The plant tried several approaches to gas cooling but wasn't confident the target temperature was achieved consistently during upset conditions. The plant was very concerned about damage to the baghouse from hot gas.

Solution: Dual-Nozzle Injector

The solution was a single injector equipped with two FloMax® nozzles. One nozzle sprays co-currently to cool the gas. The other nozzle is for emergency quench should an upset condition requiring immediate action occur. The injector design includes an air purge, which draws air from the outside to keep the injector cool.

OVERVIEW:

- Unique two-nozzle, high turndown design
- Quick disconnect for easy maintenance

BUILT-TO-SPEC SOLUTIONS FOR CEMENT PLANTS



Lime Kiln Quench Injector



Kiln Cooling Injector



UNIQUE INJECTOR SOLUTIONS FOR STEEL MILLS

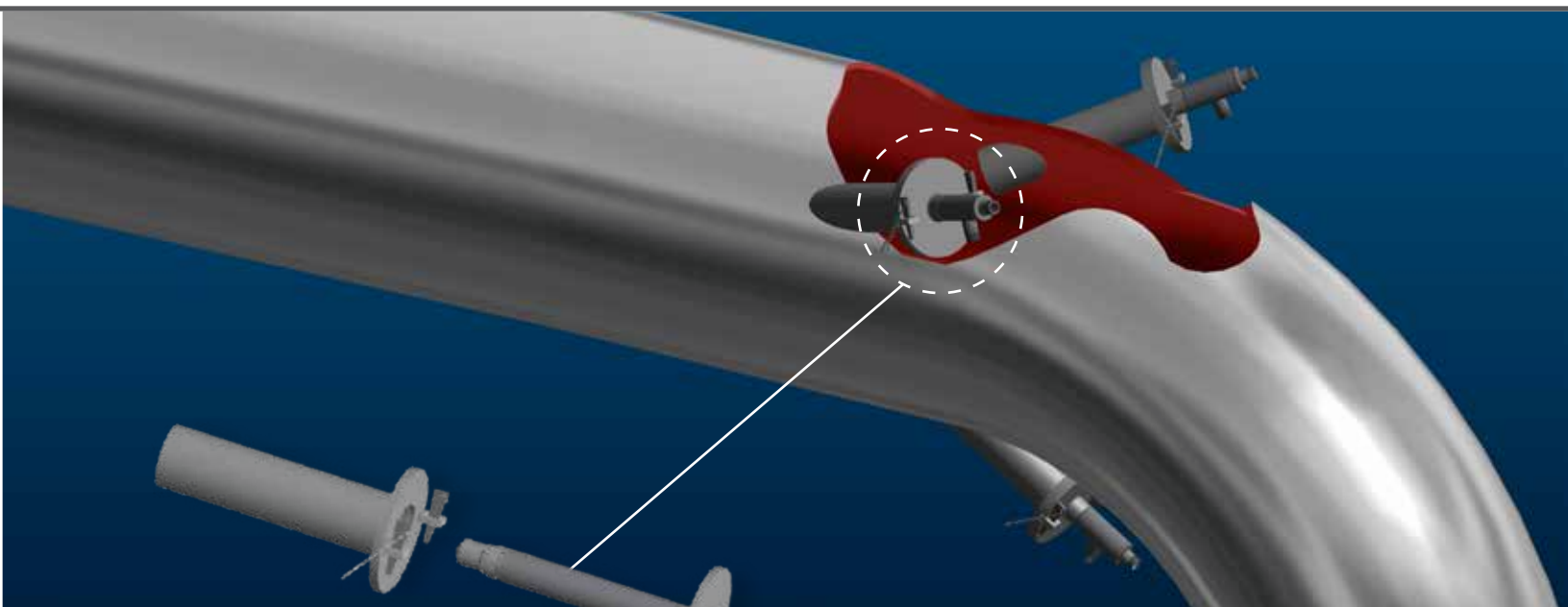

GAS COOLING PRIOR TO BAGHOUSE

Problem: Lost Production Time Due to Poor Gas Cooling

Ineffective cooling of hot gas in ductwork prior to a baghouse and an electric arc furnace (EAF) were causing several high temperature alerts per week. The alerts caused the EAF to automatically shut down until the temperature was decreased. The poor cooling also caused wet ductwork and wet dust in the baghouse – a significant maintenance problem.

Solution: Multiple Injectors and Automatic Control

Three injectors, each equipped with a FloMax® nozzle that produces very small drops, provided the solution along with optimum placement of the injectors in the gas stream. The injectors are now positioned around the duct and spray co-current with the exhaust gas flow at an angle approximately 40° from the duct wall. The injectors are controlled by an AutoJet® Gas Cooling system, which uses closed-loop control to maintain the desired gas temperature. The flow rate is controlled automatically, and the drop size is maintained by varying the air pressure based on the liquid flow to ensure 100% evaporation.

BUILT-TO-SPEC SOLUTIONS FOR STEEL MILLS



Gas Cooling Injector

OVERVIEW:





- Precise injector placement allows longest droplet residence time and 100% evaporation
- Air purge helps keep nozzles cool and minimizes buildup
- System can be expanded – a fourth injector can be added to handle gas and temperature increases

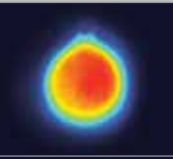

SELECTION AND SPECIFICATION TECHNICAL REFERENCE

SPRAY NOZZLES

- Provide a specific volume of fluid at a specified pressure drop
- Convert fluid into a predictable drop size spectrum with a specific spray coverage
- **Hydraulic nozzles force fluid through a small orifice in the nozzle as a high velocity jet.** The friction between the fluid environment and fluid turbulence disrupts the stream, breaking it into ligaments and droplets. The spray is shaped into a pattern depending on nozzle type

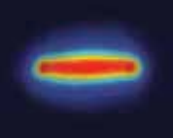
Spray Patterns	Pattern Image	Typical Injector Uses
 <p>Full cone</p>		<ul style="list-style-type: none"> • Gas scrubbing • Defoaming • Torch oil
 <p>Hollow cone</p>		<ul style="list-style-type: none"> • Gas cooling • NOx control • Desuperheating • Gas scrubbing • Quenching
 <p>Flat spray</p>		<ul style="list-style-type: none"> • Steam quench • Torch oil • Catalyst cooling

- **Dual-fluid (air atomizing) nozzles mix gas or steam and liquid in an internal chamber.** The spray exits the orifice in a shape determined by the type of spray tip

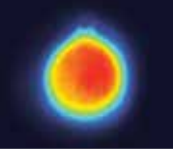
Spray Pattern	Pattern Image	Typical Injector Uses
 <p>Full cone</p>		<ul style="list-style-type: none"> • Gas cooling • Feed injection • NOx control • Quenching

ATOMIZATION

- Atomization of a liquid involves breaking the liquid up into very small pieces called drops
- Primary breakup
- Every spray nozzle provides a range of drop sizes rather than one single size
- The drop size range varies with:
 - Nozzle type
 - Capacity
 - Pressure
 - Liquid properties
 - Spray angle

DROP SIZE

By volume, one 500 µm droplet is equal to:

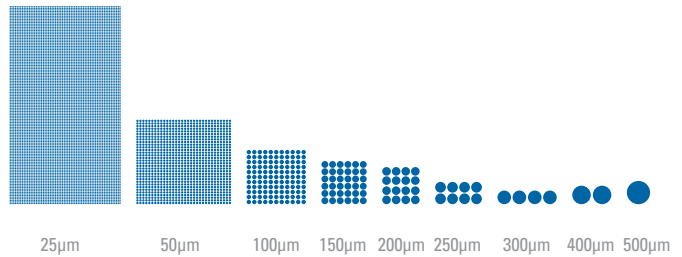

Surface area = $4 \pi r^2$ Volume = $\frac{4}{3} \pi r^3$
Mass transfer is proportional to the surface area

SPRAY DIRECTION

Co-Current Spraying

- Allows a variety of insertion options
- Reduces bearding on nozzles
- Spray is entrained in the center of process stream
- Possibility of spray impingement onto pipe wall
- Requires faster reaction time

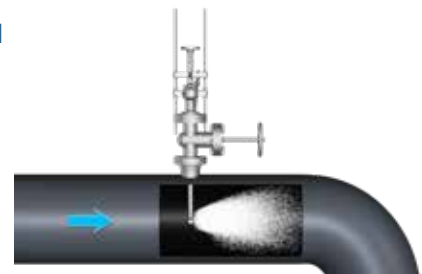

Counter-Current Spraying

- Longer residence time
- Opens spray angle
- Potentially smaller droplets
- Limited insertion options
- Buildup on injector pipes
- Causes larger drops to release (large Dmax)
- Increased stress on pipe

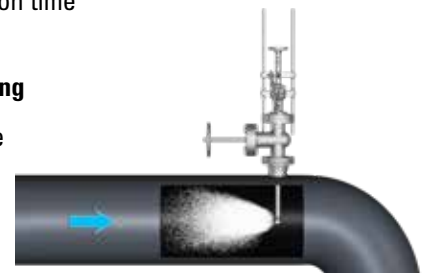

INJECTOR DESIGNS

All injectors are built-to-order and can be designed and fabricated according to ASME B31.3, European Pressure Equipment Directive and other customer-specified codes and U-stamp compliance. The following list includes the most common types of injector designs:

- Hydraulic injectors
- Single nozzle injectors
- Water-jacketed injectors
- Insulated injectors
- Insulated recirculation injectors
- Sulfur-burning injectors
- Low-profile injectors
- Multi-directional injectors
- Desuperheating injectors
- Multiple nozzle injectors
- Retractable injectors
- Air/gas atomizing injectors
- Recirculation injectors
- Air purge injectors
- Kiln injectors
- Humidification injectors

ADDITIONAL EQUIPMENT/ACCESSORIES

- Quills and spool pieces
- Valve regulation packages
- Hose kit/mounting tube kits
- Liquid manifolds

MODELING SERVICES

Computational Fluid Dynamics (CFD)

- Liquid and gas flow in scrubbers, towers, ducts and dryers
- Internal flow characteristics in spray nozzles
- Gas and liquid mixing in two-fluid nozzles
- Wall impact and shadowing

Finite Element Methods (FEM)

- Spray injector design
- Material suitability with effects of pressure loads, thermal stresses and corrosion

Fluid Structure Interaction (FSI)

- The interaction between fluid flow at given conditions and the affected solid structure
- Vibration analysis, thermal failure, fatigue
- The impact of changes in various design parameters or process condition changes

TESTING SERVICES

ASME® B31.1 and B31.3 Testing

- Visual testing
- Radiographic examination – 5%
- Liquid penetrant examination – 100%
- Material testing reports
- Hydrotesting
- Weld map

Custom Testing

- Radiographic examination – 100%
- Liquid penetrant examination – 100%
- Ultrasonic examination
- Magnetic particle examination
- Positive material identification of all components
- Ferrite test of weld
- Letter of compliance
- Weld map
- Spray and flow testing



LUNCH & LEARN WORKSHOP

For more information or a no-obligation Lunch & Learn Workshop on nozzle selection, injector design/placement and modeling services, please contact your local sales engineer.

References available upon request.



ASME® is a registered trademark of American Society of Mechanical Engineers (ASME, ASME International).



Spraying Systems Co.

Experts in Spray Technology

North Avenue and Schmale Road, P.O. Box 7900, Wheaton, IL 60187-7901 USA

Tel: 1.800.95.SPRAY Intl. Tel: 1.630.665.5000

Fax: 1.888.95.SPRAY Intl. Fax: 1.630.260.0842

www.spray.com



Bulletin No. 579C Printed in the U.S.A. ©Spraying Systems Co. 2019