



Spraying Systems Co.®
Experts in Spray Technology

PULP & PAPER MILL SPRAY TECHNOLOGY





COMPREHENSIVE SPRAY TECHNOLOGY SOLUTIONS FROM A SINGLE SOURCE

WE LOOK FORWARD TO HELPING YOU OPTIMIZE YOUR OPERATIONS INVOLVING SPRAY TECHNOLOGY.

Many of our showers and nozzles are specially designed for use in pulp, paper and tissue mills. Our products are optimized for transfer efficiency, impact, precision, water conservation, quick maintenance and more. We have the most comprehensive line of spray products available — and are always willing to make nozzles in different materials and sizes to ensure you get the performance you need. In addition to standard showers, our built-to-order showers are customized to your requirements.















- Use this catalog to research nozzles, shower options, chest cleaners and more. You'll also find additional catalogs on these product lines on spray.com:
 - Industrial hydraulic spray products
 - TankJet® tank cleaning products
 - Automatic & air atomizing spray nozzles
 - GunJet® spray guns
 - WindJet® air products
- Tap into local spray expertise: your local spray expert is always nearby and willing to help. Even when operations seem to be working properly, there may be ways to further reduce waste and maximize uptime. Your local expert can conduct an on-site, no-cost optimization evaluation, demonstrate products, conduct proof-of-concept tests and assist with payback calculations.
- Advance your sustainability goals. Your local expert can offer solutions that reduce waste and use water and energy more efficiently.
- Implement the best possible solution. By simulating your operating conditions in our spray laboratories or using Computational Fluid Dynamics (CFD) modeling, we can determine which shower designs and nozzles will be most effective. See page A5.

For nearly 80 years, our sole focus has been on spray technology. We provide engineering and technical support to mills around the world from our ten manufacturing facilities and more than 90 sales offices.

Just give us a call at 1.800.95.SPRAY or visit spray.com to learn more.



TABLE OF CONTENTS

Pulp, Paper and Tissue Production	2 ▶	
Fabrication and Testing	A1 ▶	
Showers	B1 ▶	
Shower Nozzles	C1 ▶	
Web-Trimming Nozzles	D1 ▶	
Flat Spray Nozzles	E1 ▶	
Hollow Cone Nozzles	F1 ▶	
Automatic and Air Atomizing Nozzles	G1 ▶	
Chest Cleaners	H1 ▶	
Air Knife Packages and Air Nozzles	I1 ▶	
Spray Guns	J1 ▶	
Optimization Tips	K1 ▶	
Index	i-1 ▶	
Performance Data for Sections C, D, E and F	1 ▶	



SOLUTIONS FOR MAKING PULP, PAPER & TISSUE

WOOD PREPARATION & PULPING

PULPING

- Testing and modeling using Computational Fluid Dynamics (CFD)
- VeeJet® flat spray nozzles
- WhirlJet® CF, CX and CRC hollow cone nozzles
- Black liquor nozzles

BLEACHING

- NeedleJet shower nozzles, 19124
- Built-to-order brushless, brush-type and oscillating showers
- TankJet® tank cleaning equipment
- VeeJet and NeedleJet nozzles in corrosion-resistant materials

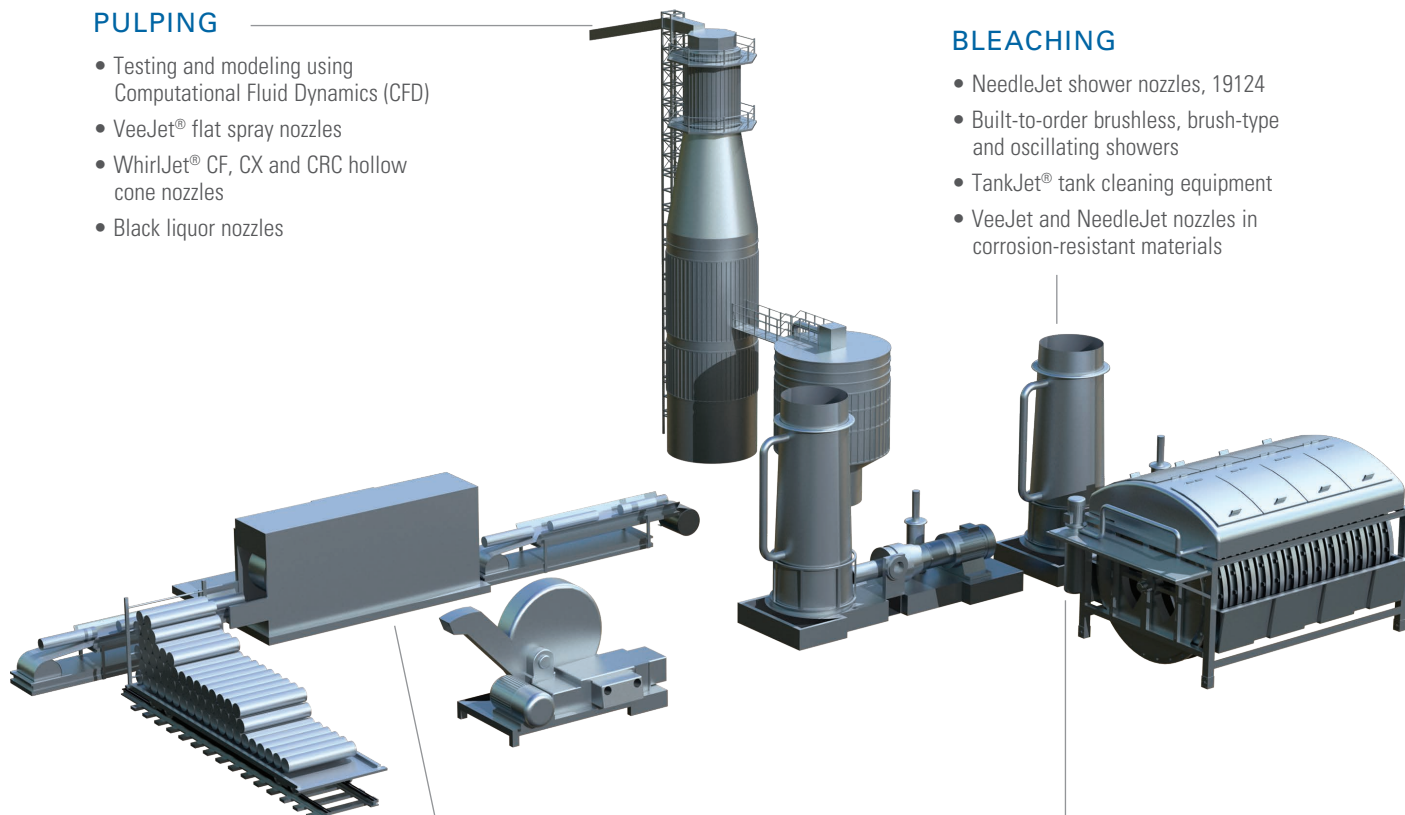

WOOD PREPARATION

- WhirlJet AX and BX hollow cone nozzles
- VeeJet and UniJet® flat spray nozzles
- Air atomizing nozzles

STOCK PREPARATION

- TankJet tank cleaning equipment
- Self-cleaning shower nozzles
- FlatJet® flat spray nozzles
- Rotoclean® FlatJet flat spray nozzles, 115220

PAPER & TISSUE PRODUCTION

TISSUE MAKING, DRY END

- Quick VeeJet® flat spray nozzles, QVVA and 58106
- Quick UniJet® flat spray nozzles
- Pipe-in-pipe showers
- Trimming nozzles for tail cutting

WET END

- ShowerJet nozzles
- NeedleJet nozzles
- FloodJet® flat spray nozzles
- FlatJet® flat spray nozzles
- VeeJet flat spray nozzles
- Trimming nozzles and alignment devices
- Built-to-order brushless, brush-type, pipe-in-pipe and oscillating showers
- T-style strainers

THE PAPER MACHINE, DRY END – SIZE, PRESS AND COATING

- Built-to-order air atomizing nozzles and showers
- Box-style moisturizing showers
- PulsaJet® precision coating showers
- WindJet® air nozzles

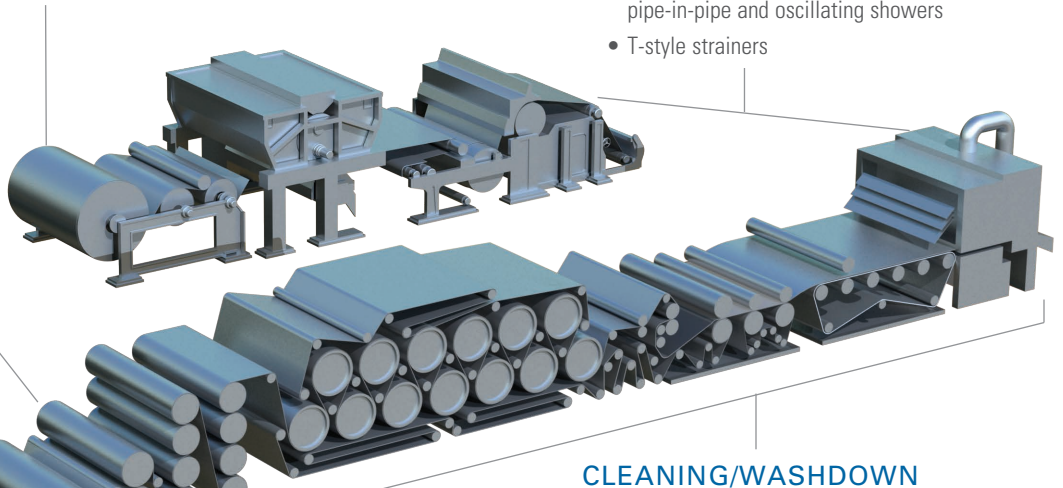

STORAGE

- YMF MiniFogger® III
- 45400 Humidification Unit
- DripSafe™ AirJet® Fogger nozzle
- 1/8JJ air atomizing nozzles

CLEANING/WASHDOWN

- GunJet® handheld spray guns
- TankJet® chest cleaners, 6353 and 27500
- WindJet air nozzles and air knife packages
- VeeJet spray nozzles

CONVERTING

CONVERTING

- PulsaJet precision coating showers
- Built-to-order air atomizing showers
- AutoJet® 1550+ modular spray system
- WindJet air nozzles
- Self-cleaning web lamination showers

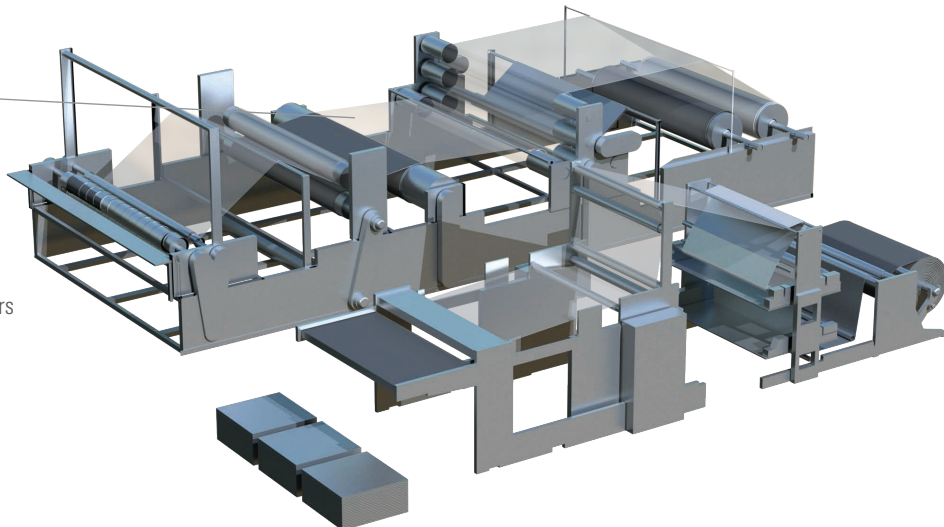



UNIQUE FABRICATION, MODELING AND TESTING SERVICES HELP ENSURE OPTIMAL PROCESS QUALITY

The most critical components in any spray system are the spray nozzles. Choosing the nozzles that will deliver the precise performance required for your operation is essential to quality. Flow rate, coverage, transfer efficiency, precision and other spray characteristics can be the difference between defect-free paper and tissue and high waste and scrap.

Once the nozzles are selected, it is just as important to ensure the equipment feeding the nozzles is optimized. Inadequate or excessive pressure and flow in showers can result in paper breaks and quality problems.

BUILT-TO-ORDER SHOWERS

OVERVIEW

Tell us what you need. Chances are we've built it before. We design and build showers for a wide range of operations. From brushless or brush-type to air atomizing and oscillating, our extensive capabilities allow us to build exactly to your specifications and needs.

Some commonly used shower designs are:

- Brushless and brush-type lubricating and chemical showers
- Brushless and brush-type pipe-in-pipe showers
- Enclosed air atomizing moisturizing showers

Connections, header length, nozzle spacing and more can be customized to fit your requirements and minimize the need for physical rework of equipment. Showers can be equipped with a wide range of conventional or quick-connect nozzles, special nozzle orientations, multiple nozzle rows or spray zones, air barriers or blow-off curtains and more.

Some examples of configurations include:

- Dual rows of nozzles to reduce the number of showers needed
- Customer-specified mounting to fit existing equipment
- Inner pipe inlet position based on existing liquid feed lines

Let us help you optimize shower performance with showers and headers that will retrofit easily into your current operations.

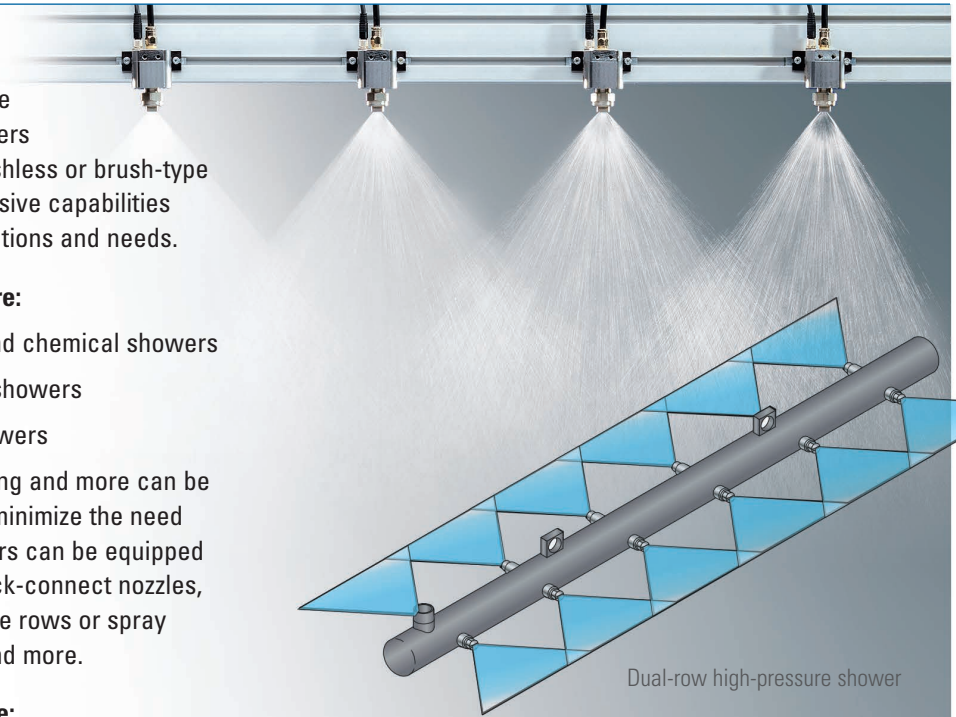

Dual-row high-pressure shower

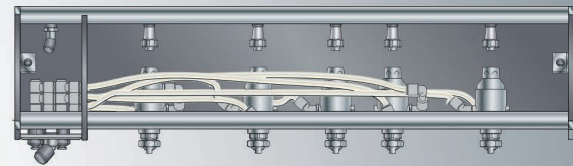

Two-zone manifold with air atomizing nozzles

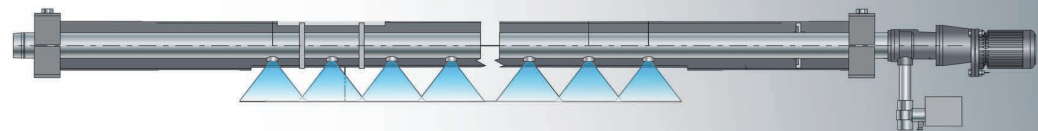

ShowerJet automatic brush shower

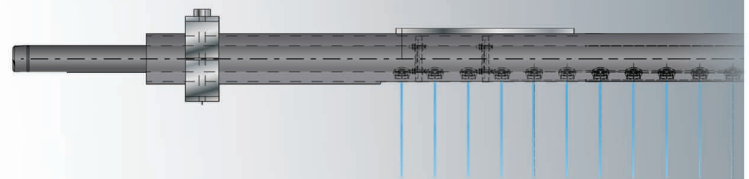

Oscillating NeedleJet shower with integrated solvent shower

Ask your local spray expert for more information on our fabrication and testing services.

SPRAY CHARACTERIZATION

OVERVIEW

In operations where spray performance is critical, it is important to understand how factors like these affect performance:

- Process conditions such as pressure, temperature and variable line speeds
- The liquid being sprayed
- The placement and position of nozzles in relation to the target

For example:

In many cases, experience and theoretical calculations can provide an indication of actual spray performance. However, testing in our spray labs determines actual performance and can eliminate costly specification mistakes or quality problems after installation.

In our state-of-the-art spray laboratories, we can adjust and/or test different nozzles and shower configurations to find the exact performance required for your operation.

Common tests include:

- Spray characterization
- Spray angle
- Drop size distribution
- Evaporation rate
- Spray impact
- Residence time
- Spray pattern
- Dwell time
- Spray coverage

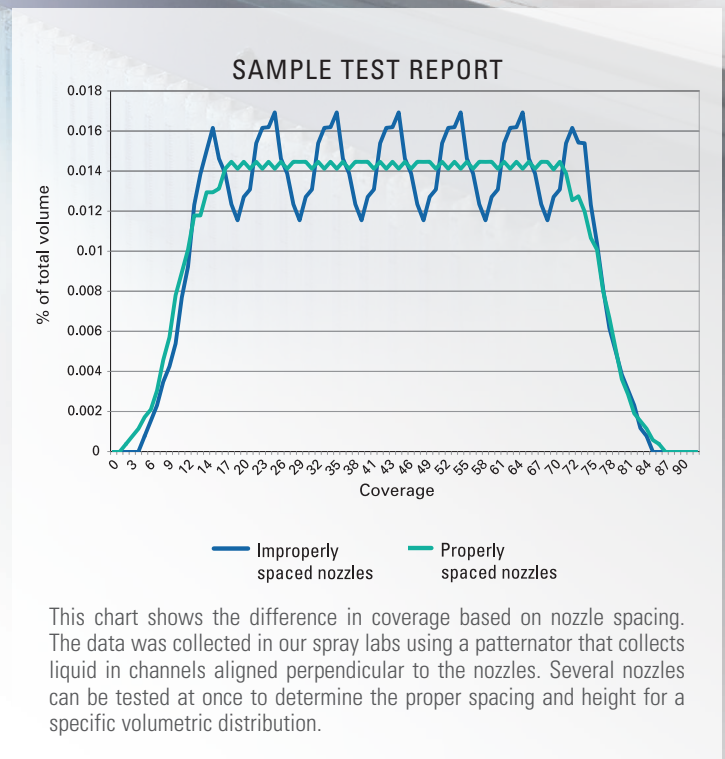

This chart shows the difference in coverage based on nozzle spacing. The data was collected in our spray labs using a patternator that collects liquid in channels aligned perpendicular to the nozzles. Several nozzles can be tested at once to determine the proper spacing and height for a specific volumetric distribution.

Ask your local spray expert for more information on our fabrication and testing services.



WEAR TESTING

OVERVIEW

Like any precision component, nozzles will wear over time. This wear is not always visible – especially in the early stages. However, even slight wear (10 to 15%) can cost thousands of dollars per month in wasted water, energy and disposal costs. In addition, you may experience quality problems since wear increases the amount of liquid being applied.

Shower nozzles that are even slightly worn will spray over capacity and waste precious water, chemicals and electricity.

We offer a free nozzle wear testing program for our customers.

Program details:

- Ship nozzles from various points on a single shower to us after they've been in use for several months
- Tests will be conducted in our spray labs to determine the wear rate
- Your nozzles will be returned to you along with recommendations for optimal replacement intervals

HERE ARE TWO EXAMPLES THAT ILLUSTRATE THE EXPENSE ASSOCIATED WITH USING WORN NOZZLES.

EXAMPLE #1: DRYER SECTION SHOWER

One shower with 70 nozzles spraying a release agent on dryer felt

The cost to operate this one shower increases from \$54,803 to \$63,073. If you have six showers in the dry end, your costs increase by \$49,620 annually.

OPERATING CONDITIONS:

- System sprays 5 gpm (19 lpm) of a 1:20 aqueous solution of chemical at 40 psi (2.76 bar)
- Chemical consumption: .25 gpm (.95 lpm); \$0.50 per gallon
- Operation: Three shifts, five days per week = 120 hours per week

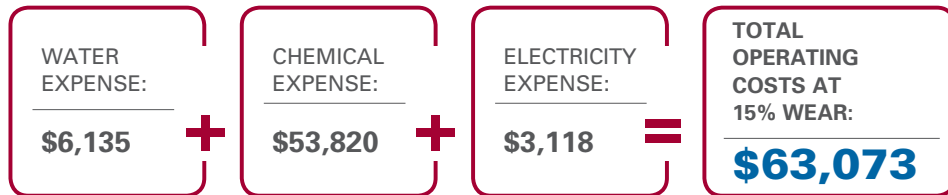

Note: Does not include water filtration and recovery costs. All costs are in USD.

EXAMPLE #2: FABRIC CLEANING SHOWER

Five showers – each with 72 high-pressure nozzles

The increased capacity for just one shower increases water consumption costs by over \$13,000 annually. Multiply that by five showers and water costs quickly escalate to over \$65,000 a year.

OPERATING CONDITIONS:

- Nozzle size: 2.34 gpm (8.8 lpm) at 350 psi (24.1 bar)
- Operation: 60 hours per week, 48 weeks per year

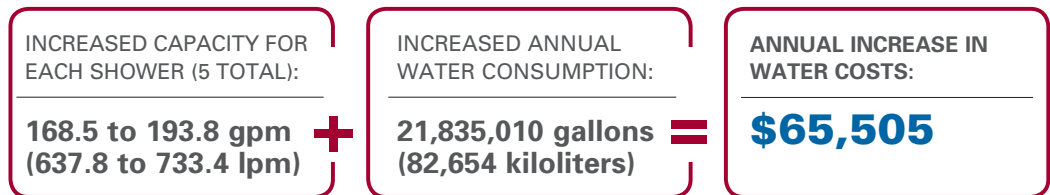

Note: Assumes water cost of \$3.00 per 1000 gallons. All costs are in USD.

Use our online Nozzle Wear Calculator to help expedite your calculation: www.spray.com

Ask your local spray expert for complete details on our complimentary nozzle wear testing program.



COMPUTATIONAL FLUID DYNAMICS (CFD) MODELING

OVERVIEW

When exact operating conditions cannot be replicated in our labs, we use CFD modeling to help achieve an optimized spray solution. Simulation provides more information about the key factors that impact the success of an application. Our models use known inputs collected in our spray labs. This proprietary data improves model accuracy and illustrates flow patterns, velocity, turbulence, droplet trajectories, internal system pressure and more.

Typical uses for CFD modeling include:

- Determination of optimal shower design and nozzle placement
- Transfer efficiency in high-speed web lines
- Turbulence analysis
- Internal flow characteristics of spray nozzles under specific operating conditions
- Gas cooling/conditioning analysis to determine lance and nozzle placement in ducts, scrubbers, furnaces, cooling towers and more











Ask your local spray expert for more information on our fabrication and testing services.



SHOWERS

TABLE OF CONTENTS

	PAGE
 Automatic Brush	B2
 PulsaJet® Manifold	B2
 AutoJet® Self-Cleaning Web Lamination	B3
 AutoJet Oscillator Shower Assembly	B3
 Air Atomizing	B4
 Pipe-in-Pipe Air Atomizing	B4
 Brushless	B5
 Spray Control Options	B5



OVERVIEW: SHOWERS

Ideal for: cleaning, coating, moisturizing and more

- Easily retrofit from manually operated showers to affordable automated versions
- Find solutions for reducing nozzle plugging and easier maintenance
- A spray controller can be added to any of our showers to optimize spray nozzle performance, lower operating costs and automate operation

MORE SOLUTIONS:

We manufacture an extensive line of showers. If you don't see exactly what you need, be sure to contact us. We custom design showers and modify existing designs for customers daily.

SHOWER OPTIONS

Automatic Brush Shower

- Affordable, automated solution eliminates the manual rotation of handwheels for improved worker safety
- An internal rotating brush assembly scrubs the interior wall of the shower as well as each disc-type shower nozzle orifice to prevent clogging and help ensure long nozzle wear life – ideal for all brush-type showers up to 3" in diameter
- Easy operation. Cleaning cycles occur automatically when used with the programmable timer. If not, activation requires a simple push of a button
- In just a few seconds, debris is swept away through the flush-out valve, restoring full liquid flow to the system without contaminating the sprayed surface
- Virtually maintenance free, aside from gear lubrication twice a year
- Straightforward and easy retrofit solution – a field brush header can be retrofitted from a manual wheel to automatic operation in as little as seven minutes

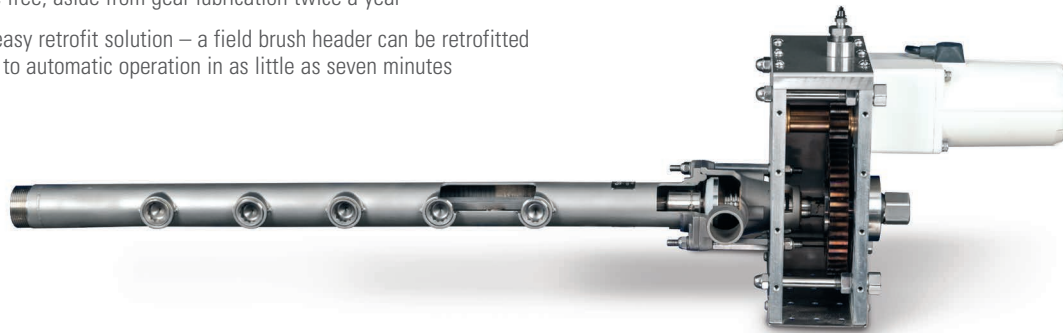

PulsaJet® Manifold

- Eliminate overspray and waste of costly chemicals
- Achieve precision spray control (PSC) when used with a wide range of AutoJet® control panels or modular PSC systems
- PSC involves switching electrically-actuated hydraulic or air atomizing nozzles on and off repeatedly at a controlled rate; pressure remains constant, enabling flow rate changes without changes in spray performance, and application rates remain consistent even when operating conditions, like line speed, change
- Increase your process control by also adding nozzle zoning across the web; change total spray coverage or alter application rate to any zone

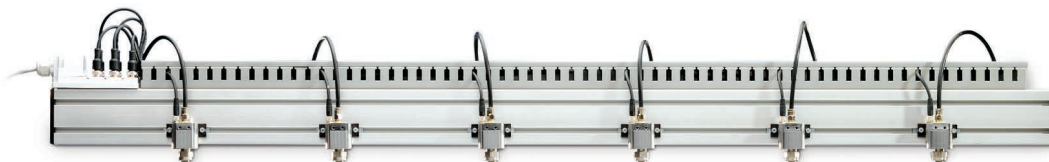

SHOWER OPTIONS

AutoJet Self-Cleaning Web Lamination Shower

- Minimize waste and scrap. Precise application of foamed adhesives on tissue creates excellent bonding without affecting the drape or softness of the material
- Extends production runs and reduces maintenance downtime – automatically cleans the inside of the header, nozzles, and air lines in place
- More efficient operation means lower operating costs compared to hot-melt and water-based spray systems
- **View the AutoJet® Self-Cleaning Headers video on spray.com/YouTube**

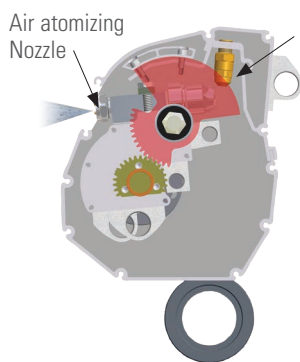

During Normal Operation

Air atomizing nozzles spray coating solution
FullJet® full cone nozzles, not in use, are housed behind a shutter

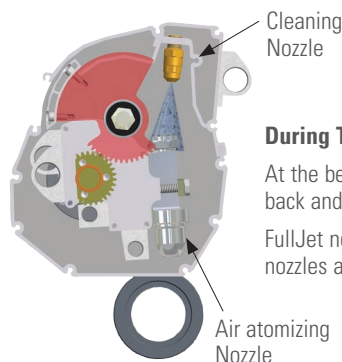

During The Cleaning Cycle

At the beginning of the cycle, the header rocks back and the shutter closes
FullJet nozzles spray directly on the air atomizing nozzles and header and remove buildup

AutoJet Oscillator Shower Assembly

- Precise movement ensures continuous and uniform felt cleaning with minimal water usage
- Users can easily and precisely control stroke and speed; settings can be stored or adjusted on-the-fly
- Alarm messages display if the controller detects operational problems
- Operating parameters can be pre-programmed prior to delivery to further simplify set-up
- Durable construction – waterproof design withstands washdown; all wetted parts are constructed of 316 stainless steel
- Easy integration into existing lines
- Integral proximity sensors use closed-loop communication to monitor stroke position and provide system protection
- Minimal maintenance



SHOWER SPECIFICATIONS

Visit spray.com/specsheets to download specification sheets or contact your local spray expert to discuss your application needs.

SHOWER OPTIONS

Air Atomizing Shower

- Headers feature compressed air to spray the most difficult solutions
- Perfect for dry end moisturizing showers, specialty showers, or very low application rates
- Small header segments with consolidated connections drive multiple nozzles from each feed, no more spider webs of tubing
- Built to order for machine widths and mounting arrangements
- Optional zoning of header segments for sheet width changes
- Nozzles can be equipped with clean-out needles to minimize clogging
- Optional stainless steel enclosure protects nozzles and air and liquid lines; cover is hinged to provide easy access
- Optional mounting assembly permits rotation of the shower

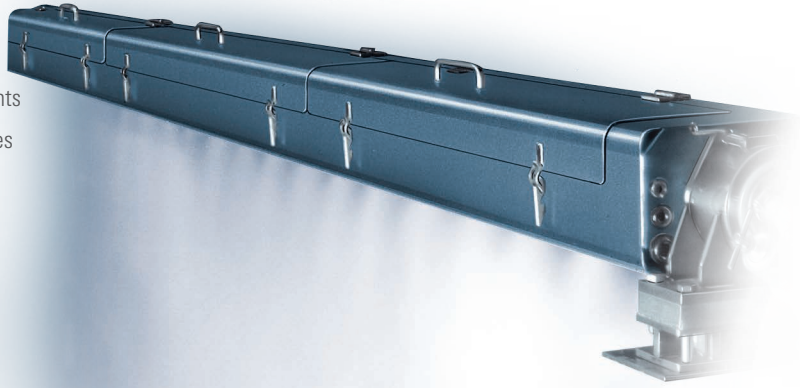

Pipe-in-Pipe Air Atomizing Shower

- Protects nozzles from overspray, dirt, dust and accidental damage
- Outer slotted tube encloses a conventional pipe manifold
- Economical alternative to a traditional box-style manifold
- Economical air atomizing shower for difficult-to-spray solutions
- Can also be used with brush or brushless internal showers
- Lightweight for easy installation



SHOWER OPTIONS

Brushless Shower

- Designed for use with fresh water and operations where nozzle clogging is unlikely
- For use with self-cleaning nozzles when brushes are not desired
- Economical

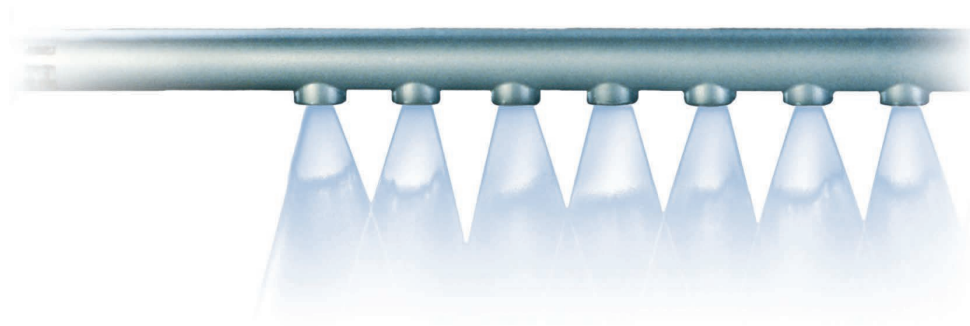

SPRAY CONTROL OPTIONS

A spray controller can be added to any of our showers to optimize spray nozzle performance, lower operating costs and automate operation. More critical operations, such as coating and moisturizing, tend to experience the greatest efficiency and performance gains resulting from precise control of our automatic spray nozzles.

Spray control benefits include:

- Line speed following
- Zone control of nozzles
- Precision application of costly coatings or chemicals to minimize waste
- Separate control of liquid, air and fan air pressure to ensure proper flow rate, spray angle and drop size
- Maximize nozzle cycle times
- Improve troubleshooting of spray performance
- Operator notification or shut-down on specified faults
- Easy integration with existing plant control systems

For information on controllers, see Automatic and Air Atomizing Spray Nozzles, Cat. 76, section B



Our AutoJet Spray Controllers range from basic to advanced.

SHOWER SPECIFICATIONS

Visit spray.com/specsheets to download specification sheets or contact your local spray expert to discuss your application needs.

QUICK REFERENCE GUIDE

Shower Type	Materials of Construction	Nozzle Compatibility	Ideal For
Automatic Brush	Pipe: 304 stainless steel or 316 stainless steel	ShowerJet, plus a wide variety of nozzles	Hard-to-reach brush showers in forming and press sections
PulsaJet® Manifold	Anodized aluminum	PulsaJet automatic spray nozzles	Converting applications and fine control over application rate of expensive chemistries
Web Lamination	Header: Anodized aluminum Wetted components: Anodized aluminum, stainless steel, Viton®, Buna®, nylon, nickel-plated brass	1/8JJAU	Spraying glues for web lamination
AutoJet® Oscillator Shower Assembly	Wetted components: 316 stainless steel Bearings: PTFE	Self-cleaning, ShowerJet, DiscJet® nozzles and more	Upgrading fabric cleaning showers in press and forming sections
Air Atomizing	316 stainless steel	VMAU, VAU, VAA, 1/4JAU with plate mount, AirJet® fogger nozzles	Difficult-to-spray solutions, very low flow rates, or remoisturizing showers
Pipe-in-Pipe Air Atomizing	Pipe: 304 stainless steel or 316 stainless steel	1/8JJAU and 1/4JAU automatic spray nozzles with integrated check valves and strainers	Economical remoisturizing showers
Brushless	Pipe: 304 stainless steel or 316 stainless steel	Self-cleaning, ShowerJet, DiscJet nozzles and more	Entry level chemical or lubrication showers for press and forming section

SHOWER SPECIFICATIONS







Visit spray.com/specsheets to download specification sheets or contact your local spray expert to discuss your application needs.





SHOWER NOZZLES

TABLE OF CONTENTS

	PAGE
 ShowerJet One-piece, High-pressure	C3
 ShowerJet Disc-type	C4
 Lock Rings	C5
 NeedleJet Nozzles	C6
 DiscJet® Nozzles	C8
 Self-Cleaning Nozzles	C9

SHOWER NOZZLES

QUICK REFERENCE GUIDE

QUICK REFERENCE GUIDE

Model Standard (Metric)	Connection/ Type	Connection/ Thread Size in. (mm)	Flow Rate Range gpm (lpm)	Max. Operating Pressure psi (bar)	Spray Angle	Materials
ShowerJet One-piece, High-pressure Nozzles						
73196 (M73196)	M	1-3/16"-18 (M30 x 1.5)	.02 to 1.12 gpm (.08 to 4.24 lpm)	800 psi (55 bar)	0° at 40 psi (3 bar)	316 stainless steel body with synthetic ruby orifice
73327 (M73327)	M	1-1/4"-18 (M32 x 1.5)				
37337 (M37337)	M	1-3/16"-18 (M30 x 1.5)				
38553 (M38553)	M	1-1/4"-18 (M32 x 1.5)				
39468	M	1-3/8"-12				316 stainless steel body and orifice
ShowerJet Disc-type Nozzles						
27149	Disc type	NA	.03 to 55 gpm (.11 to 208 lpm)	800 psi (55 bar)	0° to 75° at 60 psi (4 bar)	316L stainless steel body and orifice
39350	Disc type	NA	.02 to 1.12 gpm (.08 to 4.24 lpm)		0° at 40 psi (3 bar)	316 stainless steel body with ceramic orifice
48546	Disc type	NA				316L stainless steel body with synthetic ruby orifice
50790	Disc type	NA				316L stainless steel body and orifice
39485	Disc type	NA				316L stainless steel body and orifice
ShowerJet Lock Rings						
27044	M	See page C5	NA	NA	NA	316 stainless steel
31250	M	See page C5				
28376	M	See page C5				
NeedleJet Nozzles – Tapered Front						
48460	M	9/16"-24	.032 to 11.0 gpm (.12 to 41.6 lpm)	1000 psi (70 bar)	0° at 40 psi (3 bar)	316 stainless steel body with synthetic ruby orifice
19124	M	9/16"-24				316 stainless steel body and orifice
P36503	M	1/4" BSPP				316 stainless steel body and orifice
NeedleJet Nozzles – Longer Length						
56740	M	1/8" BSPP	.032 to 11.0 gpm (.12 to 41.6 lpm)	1000 psi (70 bar)	0° at 40 psi (3 bar)	316 stainless steel body with synthetic ruby orifice
48277	M	1/8"				316 stainless steel
21280	M	9/16"-24 NEF				316 stainless steel nozzle and extension tube
39458	M	9/16"-24 NEF				316 stainless steel nozzle and extension tube with ceramic orifice
NeedleJet Nozzles – Compact						
22812	M	1/8"	.032 to 11.0 gpm (.12 to 41.6 lpm)	1000 psi (70 bar)	0° at 40 psi (3 bar)	316 stainless steel body and orifice
20094	M	1/4"-28 UNF				
DiscJet® Nozzles						
DK	Disc type	Threadless	.025 to 16.7 gpm (.09 to 63.22 lpm)	150 psi (10 bar)	0° to 90° at 40 psi (3 bar)	303 stainless steel or 316 stainless steel
DJ	M	5/8"-18			25° to 110° at 40 psi (3 bar)	
48284	Disc type	Threadless			0° at 40 psi (3 bar)	316 stainless steel
25834	Disc type	Threadless				
Self-cleaning Nozzles						
20210	M	1-1/8"-20	.008 to 12.6 gpm (.03 to 47.7 lpm)	250 psi (17 bar)	0° to 130° at 40 psi (3 bar)	316 stainless steel deflector, body, piston, nut and spring
20235	M	3/4"-20				



SHOWERJET ONE-PIECE, HIGH-PRESSURE

SHOWER NOZZLES

OVERVIEW: SHOWERJET ONE-PIECE, HIGH-PRESSURE NOZZLES

Ideal for: easy replacement of ShowerJet and most other manufacturer showers

- Consolidated nozzle design eliminates the separate nut and gasket. All-in-one design saves time during installation and removal
- Faster and easier installation into the header using a 3/8" (9.5 mm) hex wrench
- Available in a variety of body lengths
- Powerful solid stream spray from .02 to 1.12 gpm (.08 to 4.24 lpm)
- Operating pressures up to 800 psi (55 bar)

ONE-PIECE, HIGH-PRESSURE NOZZLE OPTIONS



73196 & 73327

Solid stream spray pattern
 Ruby orifice for longer wear life
 Integral lock rings



37337, 38553 & 39468

Solid stream spray pattern
 Stainless steel orifices

QUICK REFERENCE GUIDE

Model Standard (Metric)	Connection Thread Size in. (mm)	Flow Rate Range gpm (lpm)	Materials
73196 (M73196)	1-3/16"-18 (M30 x 1.5)	.02 to 1.12 gpm (.08 to 4.24 lpm)	316 stainless steel body with synthetic ruby orifice
73327 (M73327)	1-1/4"-18 (M32 x 1.5)		
37337 (M37337)	1-3/16"-18 (M30 x 1.5)		316 stainless steel body and orifice
38553 (M38553)	1-1/4"-18 (M32 x 1.5)		
39468	1-3/8"-12		

FOR DETAILED NOZZLE PERFORMANCE DATA, SEE

- Standard Units
- Metric Units

OVERVIEW: SHOWERJET DISC-TYPE NOZZLES

Ideal for: use with automatic brush showers

- Disc-type nozzles fit inside the shower; the internal brushes easily sweep debris away
- Lock ring holds the nozzles in place
- Available in flat and solid stream spray patterns
- Solid stream versions: Choose from ceramic, stainless steel or synthetic ruby orifice material for longer wear life
- Notches on flat spray version allow removal of installed nozzles from the base with a flathead screwdriver – a Spraying Systems Co. exclusive
- All ShowerJet nozzles are installed with a standard gasket which is included, CP28624-001
- 27149 provides uniform spray distribution from .03 to 55 gpm (.11 to 208 lpm)
- 39350, 48546, 50790 & 39485 powerful solid stream spray from .02 to 1.12 gpm (.08 to 4.24 lpm)
- Operating pressures up to 800 psi (55 bar)

DISC-TYPE NOZZLE OPTIONS

27149

- Notched flats for easy removal
- Flat spray pattern
- 316L stainless steel orifice



39350

- Dome shape
- Solid stream spray pattern
- Ceramic orifice



48546

- Dome shape
- Solid stream spray pattern
- 316L stainless steel body; synthetic ruby orifice

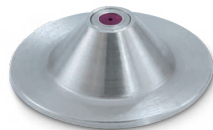

50790 & 39485

- Low profile design
- Solid stream spray pattern
- 50790 has a 316L stainless steel body and synthetic ruby orifice; 39485 has a 316L stainless steel body and orifice
- Order 50790 for Stamm showers; 50790-1 for Spraying Systems Co. showers



FOR DETAILED NOZZLE PERFORMANCE DATA, SEE

- Standard Units
- Metric Units

LOCK RING OPTIONS

27044 and 31250

- 27044 for use with Spraying Systems Co. shower bases
- 31250 for use with shower bases from other manufacturers



Model	Thread Size	For Shower Headers Supplied By
CP27044-001-316SS	1-3/16"-18 UNEF	SSCo. Standard/NASH-CVN
CP27044-002-316SS	1-3/16"-18 UNEF	SSCo. 75° ShowerJet
CP31250-001-316SS	M32 x 1.5	Valmet
CP31250-002-316SS	M30 x 1	Stamm
CP31250-003-316SS	1-1/4"-18 UNEF	Lechler
CP31250-005-316SS	M30 x 1.5	Voith

28376, 29676 and 29677

- Convert existing showers to alternate nozzles as needs change
- Can be used with dome strainer 28900 when on a brush header
- Thread sizes for Spraying System Co and competitive showers

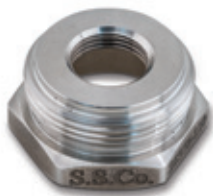

Part Number	"A" Thread	"B" Thread
28376-1/4-316SS	1/4"	1-3/16"-18
28376-3/8-316SS	3/8"	1-3/16"-18
28376-110-316SS	9/16"-24	1-3/16"-18
29676-1/4-316SS	1/4"	1-1/4"-18
29676-3/8 x 1-1/4-316SS	3/8"	1-1/4"-18
29676-1/4 x M30 x 1-316SS	1/4"	M30 x 1.0
29676-103-316SS	9/16"-24	M30 x 1.0
29676-1/4 x M30 x 1.5-316SS	1/4"	M30 x 1.5
29676-1/4 x M32 x 1.5-316SS	1/4"	M32 x 1.5
29676-1/8 x M32 x 1.5-316SS	1/8"	M32 x 1.5
29676-202-316SS	9/16"-24	M32 x 1.5
29677-P x 1-1/8-316SS	PLUG	1-1/8"-20
29677-1/4 x 1-3/4-316SS	1/4"	1-3/4"-8

FOR DETAILED NOZZLE PERFORMANCE DATA, SEE

 Standard Units
  Metric Units

OVERVIEW: NEEDLEJET NOZZLES



Ideal for: effectively cleaning and washing of felts, fabric/wire and suction rolls

- High-performance NeedleJet nozzles provide powerful solid stream sprays to effectively clean and wash felts, fabric/wire and suction rolls
- Precision-machined to provide tight flow control
- For use with a wide range of showers, including oscillating
- Versions with tubes or extensions in the back end that protrude higher into the shower. This enables better quality water to be drawn into the nozzle and minimizes turbulence
- Powerful solid stream spray from .032 to 11.0 gpm (.12 to 41.6 lpm)
- Operating pressures up to 1000 psi (70 bar)

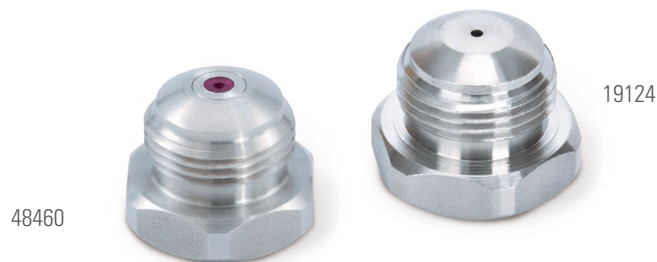
NEEDLEJET NOZZLE OPTIONS







STYLES

Model	Model Type	Description	Connection Thread Size	Hex in. (mm)	Materials
	48460	Tapered front	9/16"-24 NEF	11/16 (17.5)	316 stainless steel body with synthetic ruby orifice
	19124	Tapered front	9/16"-24 NEF	11/16 (17.5)	316 stainless steel
	P36503	Tapered front	1/4" BSPP	11/16 (17.5)	316 stainless steel

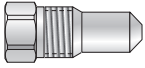
NEEDLEJET

SHOWER NOZZLES

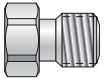
Model	Model Type	Description	Connection Thread Size	Hex in. (mm)	Materials
	56740	Longer length design	1/8" BSPP	7/16 (11.1)	316 stainless steel body with synthetic ruby orifice
	48277	Longer length design with extended inlet	1/8"	7/16 (11.1)	316 stainless steel
	21280	Longer length design with extended inlet	9/16"-24 NEF	11/16 (17.5)	316 stainless steel – nozzle and extension tube
	39458	Longer length design with extended inlet	9/16"-24 NEF	11/16 (17.5)	316 stainless steel nozzle and extension tube; ceramic orifice
	22812	Compact design; front of nozzle is flat, not rounded	1/8"	7/16 (11.1)	316 stainless steel
	20094	Compact design	1/4"-28 UNF	5/16 (7.9)	316 stainless steel

FOR DETAILED NOZZLE PERFORMANCE DATA, SEE

 Standard Units

 Metric Units



OVERVIEW: DISCJET NOZZLES

Ideal for: fitting into tight spaces

- DiscJet nozzles are ideal for when space is tight; nozzle flush mounts in shower
- Compact design provides uniform coverage
- Provides effective cleaning with minimal water use
- Entrance to orifice designed to prevent clogging
- Offset 5° from shower axis to avoid interference with adjacent sprays
- For use with 46143 retainer cap and 46144 gasket
- Powerful solid stream spray from .025 to 16.7 gpm (.09 to 63.22 lpm)
- Operating pressures up to 150 psi (10 bar)

DISCJET NOZZLE OPTIONS



DK versions

Flat spray pattern
Threadless connection
.125 thickness



DJ versions

Flat spray pattern
5/8"-18 threaded connection
.125 thickness



48284

Solid stream
Threadless connection
.125 thickness



25834

Solid stream
Threadless connection
.095 thickness

FOR DETAILED NOZZLE PERFORMANCE DATA, SEE



Standard Units



Metric Units



OVERVIEW: SELF-CLEANING NOZZLES

Ideal for: use in environments with suspended solids and showers with high solids content in the water

- For use with white water on save-all and knock-off showers
- Features a piston-type design. When line pressure is low, the nozzle's piston retracts to purge debris from the nozzle orifice
- Available with low or high actuator pressures
- Compact design fits easily inside paper machines
- Fast, easy installation and alignment
- Uniform spray distribution from .008 to 12.6 gpm (.03 to 47.7 lpm)
- Operating pressures up to 250 psi (17 bar)

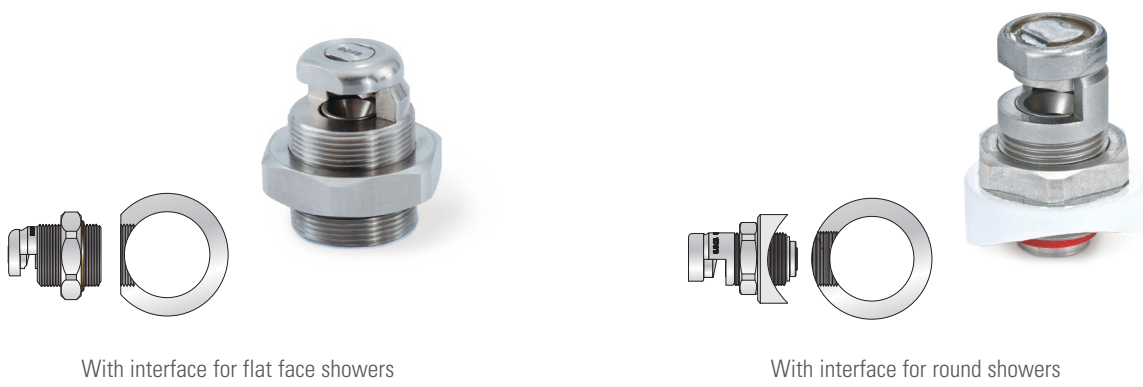

SELF-CLEANING NOZZLE OPTIONS



With interface for flat face showers

With interface for round showers

STYLES

Model	Model Type	Spray Pattern	Description	Connection Thread Size	Hex in. (mm)	Materials
	20210	Flat and solid stream	Hex nut with O-ring for interface with flat face on shower headers	1-1/8"-20 UN	1-1/2 (38.1)	316 stainless steel body with 302 stainless steel spring, Buna-N O-ring and Fairprene® diaphragm
	20235	Flat	Hex nut with polypropylene saddle gasket for interface with round shower headers	3/4"-20 UNEF	1 (25.4)	316 stainless steel body with 302 stainless steel spring, silicone rubber diaphragm and polypropylene saddle gasket
	26225	Flat and solid stream	Hex nut with O-ring interface with flat face on shower	3/4"-20 UNEF	1 (25.4)	316 stainless steel body and spring, Viton® O-ring and silicone rubber diaphragm

SHOWER NOZZLES

SELF-CLEANING

STYLES

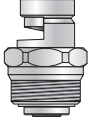
Model	Model Type	Spray Pattern	Description	Connection Thread Size	Hex in. (mm)	Materials
	26411	Flat	Solid stream pattern: hex nut with O-ring	3/4" BSPP	1-1/2 (38.1)	316 stainless steel body and spring, Viton® O-ring and natural rubber diaphragm
	36090	Flat and solid stream	Hex nut with O-ring interface with flat face on shower	M28 x 1.5	1-1/2 (38.1)	316 stainless steel body with 302 stainless steel spring, Buna-N O-ring and Fairprene® diaphragm
	38332	Flat	Self-sealing design for interface with any shower header	3/4"	1-1/16 (27)	316 stainless steel body and spring, silicone rubber diaphragm
	38490	Double solid stream*	Hex nut with O-ring interface with flat face on shower	1-1/8"-20 UN	1-1/2 (38.1)	316 stainless steel body and spring, Buna-N O-ring and Fairprene diaphragm
	49905	Double flat spray*	Hex nut with O-ring interface with flat face on shower	1-1/8"-20 UN	1-1/2 (38.1)	316 stainless steel body with 302 stainless steel spring, Buna-N O-ring and Fairprene diaphragm
	49905-1			M28 x 1.5		
	72370	Flat	Self-sealing design for interface with any shower header that has 1/2" NPT ports	1/2" NPT (male)	.812 (20.9) flats	316 stainless steel body with 302 stainless steel spring, silicone rubber diaphragm

* Capacity size is for the entire nozzle assembly.

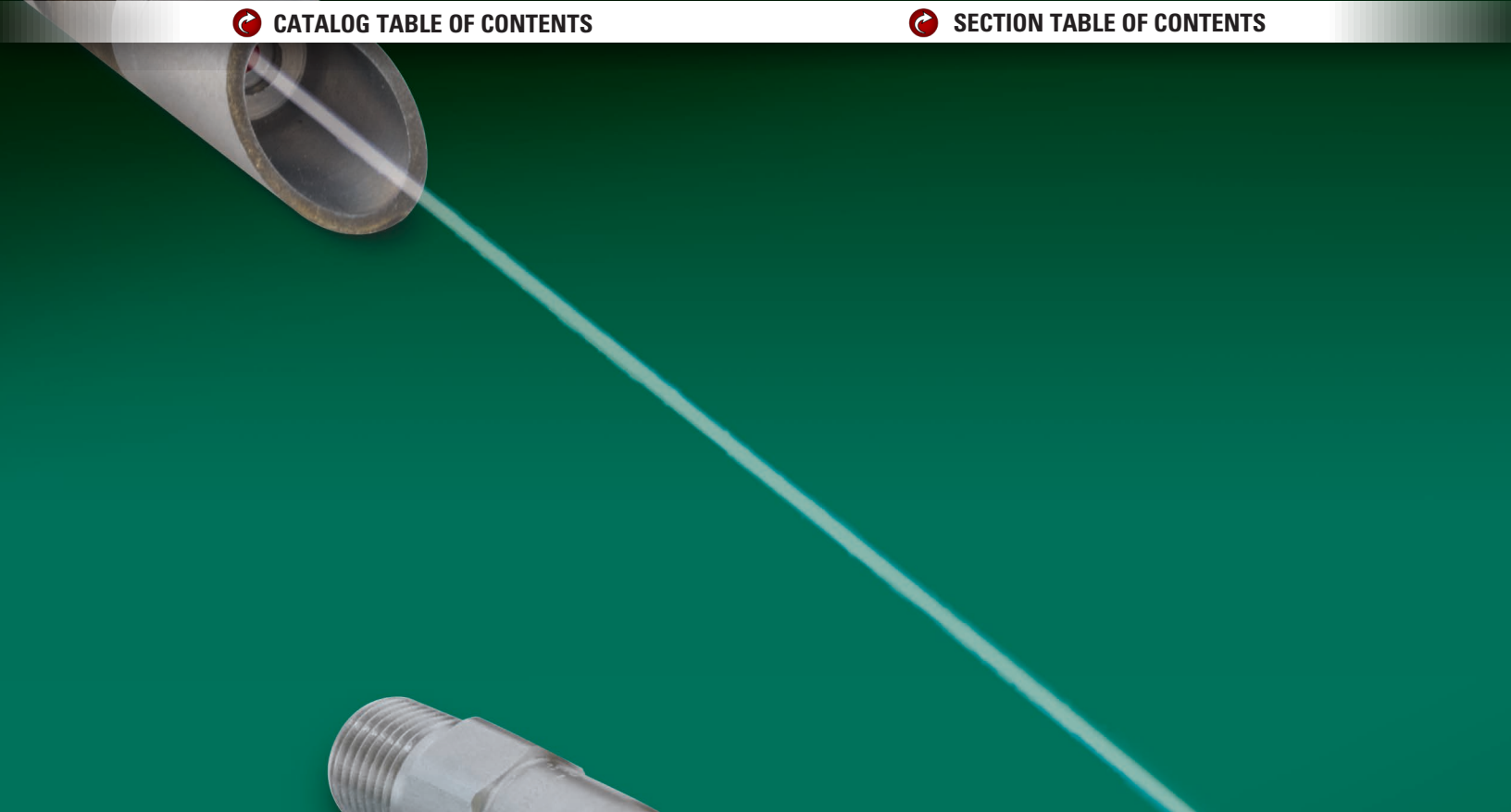

FOR DETAILED NOZZLE PERFORMANCE DATA, SEE

 Standard Units
  Metric Units



WEB TRIMMING NOZZLES

TABLE OF CONTENTS

	PAGE
 UltraStream® Nozzles	D2
 UltraStream Nozzle Accessories	D3
 UltraStream Alignment Devices	D4









OVERVIEW: ULTRASTREAM NOZZLES

Ideal for: edge trimming, cutting and slitting

- Single orifice version suitable with most paper grades
- Dual orifice versions:
 - Provide twin parallel solid stream sprays for precise edge trimming on fine and specialty papers
 - Eliminate the need for two nozzles used in tandem, reduce backsplash and simplify spray alignment
 - Feature ruby orifices for long-lasting durability
- 38170 single orifice nozzle with strainer helps minimize clogging which is especially helpful when using recirculated water
- Powerful, needle-like solid stream spray
- Nozzles can be placed further away from target to reduce buildup
- Swivel nozzle 39610 or swivel adapter 39290 can be used to align dual orifice nozzles and correctly move a drip shield to the outside of the paper web
- Nozzles 39610, 72242, 58035-2 and 56795-2 feature a shrouded orifice for protection, ease of alignment and help in guiding buildup away from the moving web
- Powerful solid stream spray from .02 to 2.3 gpm (.08 to 8.7 lpm)
- Operating pressures up to 1000 psi (70 bar)

ULTRASTREAM NOZZLE OPTIONS

 <p>38170 Single Orifice with Strainer 3/8" male connection Ceramic or 316 stainless steel orifice Brass body and brass strainer body with 304 stainless steel screen</p>	 <p>38171 Single Orifice 1/8" male connection Ceramic or 316 stainless steel orifice Brass body</p>	 <p>48461 Single Ruby Orifice 1/8" male connection Synthetic ruby orifice and 303 stainless steel body</p>
 <p>39610 Single Ruby Orifice Swivel M10 x 0.75 male connection Synthetic ruby orifice and 303 stainless steel body Shrouded orifice with 360° swivel action</p>	 <p>72242 Single Ruby Orifice 1/8" male thread connection Synthetic ruby orifice and 303 stainless steel body Shrouded orifice</p>	 <p>58035-2 and 56795-2 Dual Ruby Orifice 1/8" male or female connection Synthetic ruby orifice and 303 stainless steel body Shrouded orifice</p>

QUICK REFERENCE GUIDE

Model	Orifice	Connection/Type	Connection Size	Flow Rate Range gpm (lpm)	Max. Operating Pressure psi (bar)	Spray Angle	Materials
38170	Single	M	3/8"	.02 to 2.3 gpm (.08 to 8.7 lpm)	1000 psi (70 bar)	0° at 100 psi (4 bar)	Brass body with ceramic or 316 stainless steel orifice, 304 stainless steel screen
38171	Single	M	1/8"				Brass body with ceramic or 316 stainless steel orifice
48461	Single	M	1/8"				303 stainless steel body with synthetic ruby orifice
39610 Swivel	Single	M	M10 x 0.75				
72242	Single	M	1/8"				
58035-2, 56795-2	Dual	M/F	1/8"	.04 to 1.52 gpm (.15 to 5.75 lpm)			

OVERVIEW: ULTRASTREAM NOZZLE ACCESSORIES

- Simplify installation and speed set-up by purchasing accessories and nozzles together
- Improve precision, optimize system performance and minimize paper breaks

ULTRASTREAM NOZZLE ACCESSORY OPTIONS

115425 and 115427 Trimming Feed Converter

- Convert trimming feeds back and forth between 1/8" to M10 x 0.75 threads
- Retrofit existing installed M10 thread bases
- 115425 - Convert M10 base for 1/8" nozzle
- 115427 - Convert 1/8" base for M10 nozzle
- 303 stainless steel body



39290 Swivel Adapter

- Add swivel functionality to any 1/8" UltraStream nozzle
- 303 stainless steel body
- Suitable for use with single orifice ruby nozzle 72242 or dual orifice ruby nozzle 56795-2



**87529 Air Barrier Adapter
Shown with 48461 UltraStream**

- Prevents buildup on trim nozzles with a shroud of compressed air
- 1/8" compressed air connection
- 2 to 7 psi (0.14 to 0.48 bar) required for operation
- Can be use with any single or dual orifice UltraStream nozzle
- 303 or 316 stainless steel body



QUICK REFERENCE GUIDE

Model	Connection/Type	Inlet Connection Size/Type	Outlet Connection Thread Size/Type	Materials
115425	Inlet M Outlet F	M10 x 0.75	1/8"	303 stainless steel
115427	Inlet M Outlet F	1/8"	M10 x 0.75	303 stainless steel
39290	Inlet M Outlet F	M10 x 0.75	1/8"	303 stainless steel
87529	Inlet M Outlet F	1/8", 1/4", M10 x 0.75	1/8", M10 x 0.75	303 or 316 stainless steel

FOR DETAILED NOZZLE PERFORMANCE DATA, SEE

- Standard Units
- Metric Units

OVERVIEW: ALIGNMENT DEVICES FOR ULTRASTREAM NOZZLES

Ideal for: edge trimming

- Quick and easy adjustment of UltraStream® nozzles to the exact trim position reduces downtime for nozzle alignment up to 70%
- Use with different paper widths and grades; horizontal and rotational adjustments can be made quickly and accurately in 10 mm increments to ensure precise control of nozzle location – no tools required
- Record final positions to ensure repeatable performance using calibration devices
- Improve operator safety – handles and scales are located away from the nozzles
- Multi-pipe alignment device provides a redundant stream to prevent sheet breaks due to spitting or broken streams
- Goose-necked pipe design prevents turbulence in pipe before nozzle
- Set-up is simple – UltraStream nozzles attach easily to arms; alignment arms can be removed without disrupting remaining arms and nozzle locations
- For use with single or dual UltraStream nozzles with or without 38170 strainers
- Stainless steel construction

ALIGNMENT DEVICE OPTIONS

Multi-pipe Alignment Device 115450

3/8" outlet; 1/4" inlet

Individual pipe horizontal adjustment range: 7.9" (200 mm)

Multi-pipe slider horizontal adjustment range: 7.9" (200 mm)

Individual pipe rotational adjustment range: ± 40°

Two pipe units available upon request

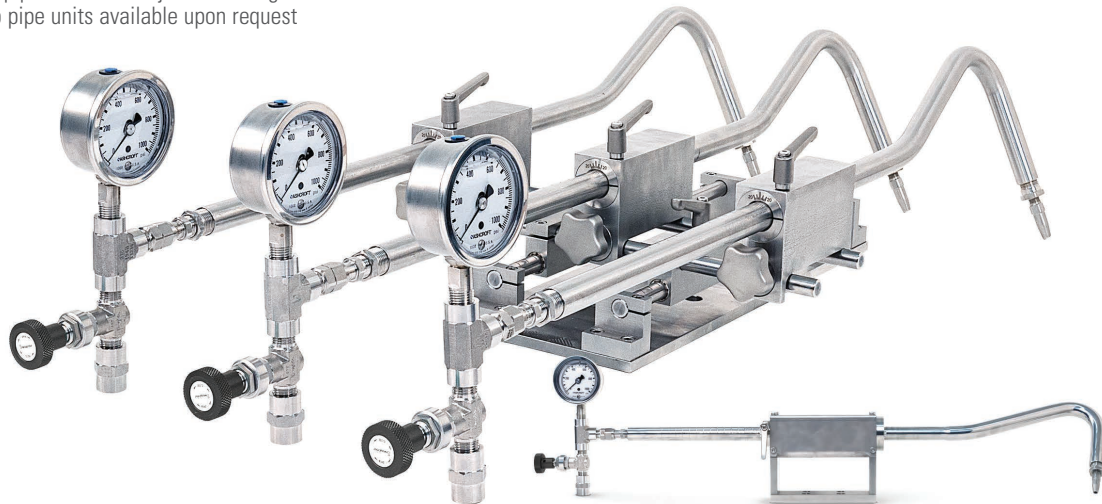

Precise control of nozzle location is easily accomplished using the rotational and horizontal scales



PLACING YOUR ORDER

Call your local spray expert for application assistance or to place an order.

Single-pipe Alignment Device Y72020

3/8" outlet; 1/4" inlet









Horizontal pipe adjustment range: 7.9" (200 mm)

Pipe rotational adjustment range: ± 40°



FLAT SPRAY NOZZLES

TABLE OF CONTENTS

	PAGE		PAGE
STANDARD SPRAY NOZZLES		NARROW ANGLE SPRAY	
 VeeJet® Nozzles	E4	 FloodJet® Wide Angle Spray Nozzles	E10
 Quick-Change Nozzles: QuickJet® & UniJet®	E5	 FlatJet® Narrow Angle Spray Nozzles	E11
 Quick-Change Nozzles: UniJet	E6	 Quick-Change Nozzles: QuickJet	E12
 Black Liquor Nozzles	E7		
WIDE ANGLE SPRAY			
 Quick-Change Nozzles: QuickJet & UniJet	E8		
 Quick-Change Nozzles: UniJet	E9		



FLAT SPRAY

FLAT SPRAY NOZZLES

S STANDARD ANGLE SPRAY

QUICK REFERENCE GUIDE

Model	Connection/ Type	Connection Size in.	Flow Rate Range gpm (lpm)	Max. Operating Pressure psi (bar)	Spray Angle	Materials
S STANDARD ANGLE SPRAY						
VeeJet® Nozzles						
H-DT nozzle	F	1/8 to 1/4	.012 to 5.3 gpm (.047 to 20.06 lpm)	500 psi (35 bar)	0° to 110° at 40 psi (3 bar)	Brass, 303 stainless steel
H-DU nozzle	F	1/8 to 1/4	.07 to 1237 gpm (.26 to 4720 lpm)			Brass, 303 stainless steel, polyvinyl chloride
H-VV nozzle	M	1/8 to 1/4	.012 to 5.3 gpm (.047 to 20.06 lpm)			Brass, mild steel, 303 stainless steel, 316 stainless steel
H-VVL nozzle	M	1/8 to 1/4				Brass, 303 stainless steel, 316 stainless steel
U nozzle	M	1 to 2	17.7 to 1237 gpm (67 to 4720 lpm)			Brass, mild steel, 303 stainless steel
Quick-Change QuickJet® Nozzles						
QUA spray tip	Use with QJA or QJJA bodies	NA	.11 to 22 gpm (.42 to 83.28 lpm)	300 psi (20 bar)	0° to 95° at 40 psi (3 bar)	Brass, 303 stainless steel
QVVA spray tip	Use with QJA or QJJA bodies	NA	.003 to 41 gpm (.01 to 155.2 lpm)			
58106 spray tip	Use with QJA or QJJA bodies	NA	.003 to 2.2 gpm (.01 to 8.33 lpm)			0° to 110° at 40 psi (3 bar)
QJA body	F	1/8 to 1/2	NA	NA	NA	Brass, 303 stainless steel
QJJA body	M	1/8 to 1/2	NA	NA	NA	
Quick-Change UniJet® Nozzles						
TPU spray tip	Use with T or TT bodies	NA	.003 to 25 gpm (.01 to 94 lpm)	500 psi (35 bar)	0° to 110° at 40 psi (3 bar)	Brass, stainless steel
13802 spray tip	Use with 14234 bodies	NA				Brass, 303 stainless steel, 316 stainless steel
58102 spray tip	Dovetail tip; threaded and weld body options	NA	.012 to 2.8 gpm (.05 to 10.6 lpm)		15° to 110° at 40 psi (3 bar)	Brass, stainless steel, 316 stainless steel
49803 spray tip	Dovetail tip; threaded and weld body options	NA	.35 to 25 gpm (1.3 to 94 lpm)			Brass, stainless steel, hardened stainless steel
T body/cap	F	1/8 to 1/2	NA	NA	NA	Brass, 303 stainless steel
TT body/cap	M	1/8 to 1/2	NA	NA	NA	
14234 body	F	1/8 to 1/2	NA	NA	NA	
Black Liquor Nozzles						
45824	M	1-1/4 or 1-1/2	60 to 150 gpm (227 to 568 lpm)	10 psi (.7 bar)	130° at 10 psi (.7 bar)	309 stainless steel
U	M	1-1/4	17.7 to 354 gpm (67 to 1340 lpm)	500 psi (35 bar)	15° to 65° at 40 psi (3 bar)	310 stainless steel



FLAT SPRAY NOZZLES

W WIDE ANGLE SPRAY

N NARROW ANGLE SPRAY

FLAT SPRAY

QUICK REFERENCE GUIDE

Model	Connection/Type	Connection Size in.	Flow Rate Range gpm (lpm)	Max. Operating Pressure psi (bar)	Spray Angle	Materials
W WIDE ANGLE SPRAY						
Quick-Change QuickJet® Nozzles						
QTKA spray tip	Use with QJA or QJJA bodies	NA	.01 to 14.7 gpm (.037 to 55 lpm)	60 psi (4 bar)	73° to 153° at 10 psi (.7 bar)	Brass, 303 stainless steel
QSTK spray tip	Use with QJJS body	NA				
QJA body	F	1/8 to 1/2	NA	NA	NA	
QJJS body	M	1/8 to 1/4	NA	NA	NA	
QJJA body	M	1/8 to 1/2	NA	NA	NA	
Quick-Change UniJet® Nozzles						
TK spray tip	Use with T or TT bodies	NA	.06 to 12.2 gpm (.28 to 46 lpm)	60 psi (4 bar)	73° to 153° at 10 psi (.7 bar)	Brass, 303 stainless steel
T body/cap	F	1/8 to 1/2	NA	NA	NA	
TT body/cap	M	1/8 to 1/2	NA	NA	NA	
FloodJet® Nozzles						
K nozzle	M	1/8 to 1	.04 to 110 gpm (.14 to 410 lpm)	60 psi (4 bar)	73° to 153° at 10 psi (.7 bar)	Brass, 303 stainless steel, 316 stainless steel, polyvinyl chloride
11499 nozzle	M	1/8	.17 to 4.4 gpm (.64 to 16.66 lpm)		98° to 133° at 10 psi (.7 bar)	316 stainless steel
13063 nozzle	M	1/8	.17 to 2.4 gpm (.64 to 9.1 lpm)			
N NARROW ANGLE SPRAY						
FlatJet® Standard Nozzles						
P nozzle	M	1/8 to 3/4	.24 to 39 gpm (.91 to 144 lpm)	150 psi (10 bar)	15° to 50° at 40 psi (3 bar)	Brass, mild steel, 303 stainless steel, 316 stainless steel
RotoClean 115220 nozzle	M	3/8	1.2 to 7.7 gpm (4.54 to 29.15 lpm)	100 psi (7 bar)	35° or 50° at 40 psi (3 bar)	316 stainless steel
Quick-Change QuickJet Nozzles						
QLPA spray tip	Use with QJLA or QJJLA bodies	NA	3.7 to 59 gpm (14.01 to 223 lpm)	100 psi (7 bar)	25° to 60° at 40 psi (3 bar)	Brass, 303 stainless steel, 316 stainless steel
QJLA body	F	3/8 to 1/2	NA	NA	NA	
QJJLA body	M	3/8 to 1/2	NA	NA	NA	



OVERVIEW: VEEJET NOZZLES

Ideal for: roll lubrication, chemical shower and edge decks

- Widely used in showers, flat spray nozzles provide a fan-type, tapered-edge pattern to ensure even coverage when multiple nozzles are used in a series
- Solid stream (0° spray angle) versions achieve the highest impact of any nozzle type
- Consistent performance over a large range of flow rates and pressures
- Uniform spray distribution with flow rates from .012 to 1237 gpm (.047 to 4720 lpm)
- Operating pressures up to 500 psi (35 bar)

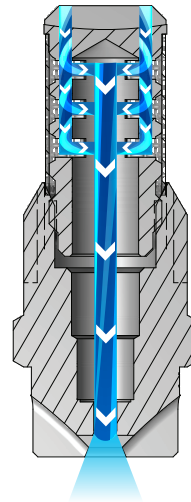

VeeJet Nozzles

As the liquid exits through the sharp V shape cut of the orifice, it forms into a flat spray pattern. The distribution is tapered from the center of the spray.

VEEJET NOZZLE OPTIONS

S



H-VV

1/8" to 1/4" male conn.
Flow rates below 1 gpm at 40 psi
(3.8 lpm at 2.8 bar)

S



H-DT

1/8" to 1/4" female conn.
Flow rates below 1 gpm at 40 psi
(3.8 lpm at 2.8 bar)

S



H-DU

1/8" to 1/4" female conn.
Flow rates of 1 gpm and greater at 40 psi
(3.8 lpm and greater at 2.8 bar)

S



H-VVL

1/8" to 1/4" male conn.
Flow rates below 1 gpm at 40 psi
(3.8 lpm at 2.8 bar)
H-VVL includes integral strainer

S



U

1" to 2" male conn.
Flow rates of 50 gpm and greater at 40 psi
(189.3 lpm and greater at 2.8 bar)

FOR DETAILED NOZZLE PERFORMANCE DATA, SEE



Standard Units



Metric Units



QUICK-CHANGE NOZZLES: QUICKJET® AND UNIJET®

S STANDARD ANGLE SPRAY

FLAT SPRAY

OVERVIEW: QUICK-CHANGE NOZZLES: QUICKJET AND UNIJET STYLES

Ideal for: yankee chemical showers and critical alignment locations

- Perfect for high-maintenance operations – bodies remain on pipe/header
- Flat fan type, tapered edge spray pattern
- Tips compatible with either male or female body
- Spray angles from 0° to 110°
- Quick VeeJet® nozzles allow:
 - Quick quarter-turn removes/installs spray tips in seconds
 - Uniform spray distribution with flow rates from .003 to 22 gpm
 - Operating pressures up to 300 psi (20 bar)
- 58106 features Quick VeeJet connection with roll pin for extra leverage upon installation or removal
- UniJet nozzles allow:
 - Easy tip change out in place – remove tips by unscrewing retainer
 - Uniform spray distribution with flow rates from .003 to 25 gpm
 - Operating pressures up to 500 psi (35 bar)

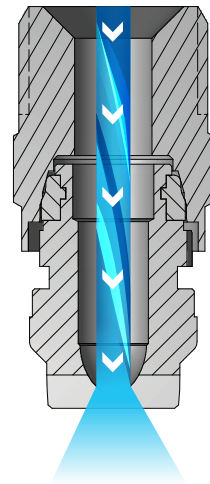

Quick VeeJet Nozzles

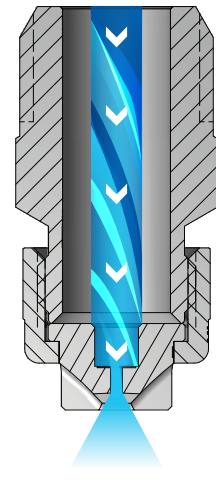

UniJet Nozzles

Quick VeeJet and UniJet Nozzles

As the liquid exits through the sharp V shape cut of the orifice, it forms into a flat spray pattern. The distribution is tapered from the center of the spray.

QUICK-CHANGE QUICKJET NOZZLE OPTIONS

S



QUA Spray Tip + QJA or QJJA Bodies
Flow rates of 1 to 8 gpm at 40 psi
(3.9 to 32 lpm at 2.8 bar)

S



QVVA Spray Tip
Flow rates below 1 gpm at 40 psi
(3.9 lpm at 2.8 bar)
Use with QJA or QJJA bodies

S



58106 Spray Tip
Flow rates below 1 gpm at 40 psi
(3.9 lpm at 2.8 bar)
Use with any QuickJet body

S



QJA Body
1/8" to 1/2" female conn.

S



QJJA Body
1/8" to 1/2" male conn.

FOR DETAILED NOZZLE PERFORMANCE DATA, SEE

Standard Units Metric Units



UNIJET NOZZLE OPTIONS

S

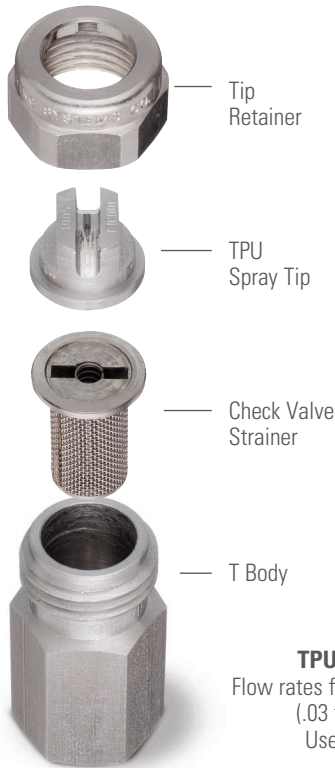

TPU Spray Tip + T Body
Flow rates from .009 to 7.0 gpm at 40 psi
(.03 to 26.5 lpm at 2.8 bar)
Use with screen strainer
and tip retainer

S



13802 Spray Tip + 14234 Body
1/8" to 1/2" female conn.
Flow rates from .009 to 7.0 gpm at
40 psi (.03 to 26.5 lpm at 2.8 bar)
Self-aligning tip with wrench flats on top of
tip: straight alignment flats connection

S



58102 Spray Tip
Flow rates below 1 gpm
at 40 psi (3.9 lpm at 2.8 bar)
Self-aligning tip with wrench flats on
top of tip and dovetail connection;
spray is offset 5° from dovetail

S



49803 Spray Tip
Flow rates from .017 to 7.0 gpm at
40 psi (.064 to 26.5 lpm at 2.8 bar)
Self-aligning tip with round top
and dovetail connection:
spray flow is 5° from offset



TT Body/Cap
1/8" to 1/2" male conn.
Use with TPU spray tip

Dovetail spray tips can be used on a variety of body types.
Please contact your sales engineer for body options and dimensions.

FOR DETAILED NOZZLE PERFORMANCE DATA, SEE
 Standard Units Metric Units

BLACK LIQUOR NOZZLES

S STANDARD ANGLE SPRAY

FLAT SPRAY

OVERVIEW: BLACK LIQUOR NOZZLES

Ideal for: recovery boilers

- Excellent heat and corrosion resistance
- 45824 Splash Plate Series provide uniform spray distribution from 60 to 150 gpm (227 to 568 lpm)
- VeeJet® U Series provide uniform spray distribution from 17.7 to 354 gpm (67 to 1340 lpm)

BLACK LIQUOR NOZZLE OPTIONS

45824 Splash Plate Series

- Splash plate design has a large exit orifice for maximum flow passage
- Cast from 309 stainless steel
- Uniform spray distribution from 60 to 150 gpm (227 to 568 lpm)
- Operating pressures up to 10 psi (.7 bar)



VeeJet U Series

- VeeJet design provides a flat fan spray pattern
- 50° spray angle at 40 psi (2.8 bar)
- Constructed of 310 stainless steel
- Uniform spray distribution from 17.7 to 354 gpm (67 to 1340 lpm)
- Operating pressures up to 500 psi (35 bar)



QUICK REFERENCE GUIDE

Model	Connection/Type	Connection Size in.	Capacity gpm (lpm) at 10 psi (.7 bar)*	Material
45824*	M	1-1/4 or 1-1/2	60-150 (227 - 568)	309 stainless steel
U	M	1-1/4	25-50 (95-189)	310 stainless steel

*Field studies indicate black liquor flow rates are approx. 50% of water flow rates

FOR DETAILED NOZZLE PERFORMANCE DATA, SEE

Standard Units

Metric Units



FLAT SPRAY

QUICK-CHANGE NOZZLES: QUICKJET®

W WIDE ANGLE SPRAY

OVERVIEW: QUICK-CHANGE NOZZLES: QUICKJET STYLES

Ideal for: uhle box, roll lubrication and chemical showers

- Perfect for high-maintenance operations – bodies remain on pipe/header
- Wide angle, deflected type flat fan spray pattern
- Quick FloodJet nozzles allow quick quarter-turn removes/installs spray tips in seconds
- Spray angles for 73° to 153°
- Uniform spray distribution from .01 to 14.7 gpm (.037 to 55 lpm)
- Operating pressures up to 60 psi (4 bar)

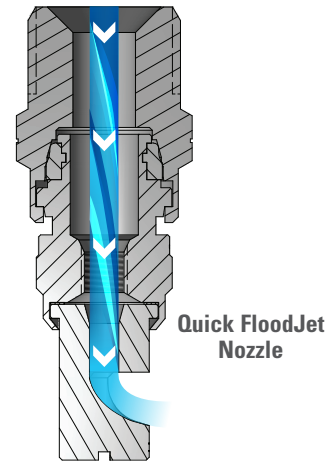

Quick FloodJet® Nozzles

The deflector surface enables the formation of very wide spray angles compared to other flat spray nozzles. As liquid passes through the nozzle, it hits the deflector surface and spreads out to form a flat spray pattern. The distribution is even from the center of the spray.

QUICK-CHANGE QUICKJET OPTIONS



Quick FloodJet Nozzle
QTKA Spray Tip + QJA Body

1/8" to 1/2" female conn.
Flow rates from .075 to 6.0 gpm at 10 psi
(.28 to 22.71 lpm at .69 bar)
Use with QJA or QJJA body



QSTK Spray Tip
Miniature version
Flow rates below 1 gpm at 40 psi
(3.9 lpm at 2.8 bar)
Use with seal and QJJS body



QJJA Body
1/8" to 1/2" male conn.



QJJS Body
Miniature version
1/8" to 1/4" male conn.

FOR DETAILED NOZZLE PERFORMANCE DATA, SEE

Standard Units Metric Units

QUICK-CHANGE NOZZLES: UNIJET®

FLAT SPRAY

W WIDE ANGLE SPRAY

OVERVIEW: QUICK-CHANGE NOZZLES: UNIJET STYLES

Ideal for: uhle box, roll lubrication and chemical showers

- Perfect for high-maintenance operations – bodies remain on pipe/header
- Wide angle, deflected type flat fan spray pattern
- UniJet FloodJet nozzle design allows easy tip change out in place – remove tips by simply unscrewing retainer
- Spray angles for 73° to 153°
- Uniform spray distribution from .06 to 12.2 gpm (.28 to 46 lpm)
- Operating pressures up to 60 psi (4 bar)

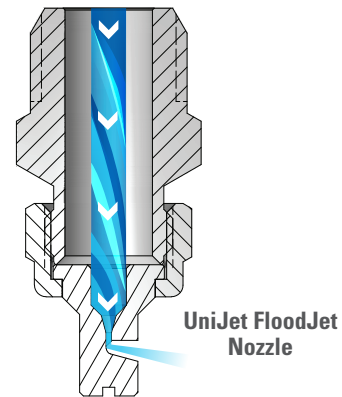

UniJet FloodJet® Nozzles

The deflector surface enables the formation of very wide spray angles compared to other flat spray nozzles. As liquid passes through the nozzle, it hits the deflector surface and spreads out to form a flat spray pattern. The distribution is even from the center of the spray.

QUICK-CHANGE UNIJET OPTIONS

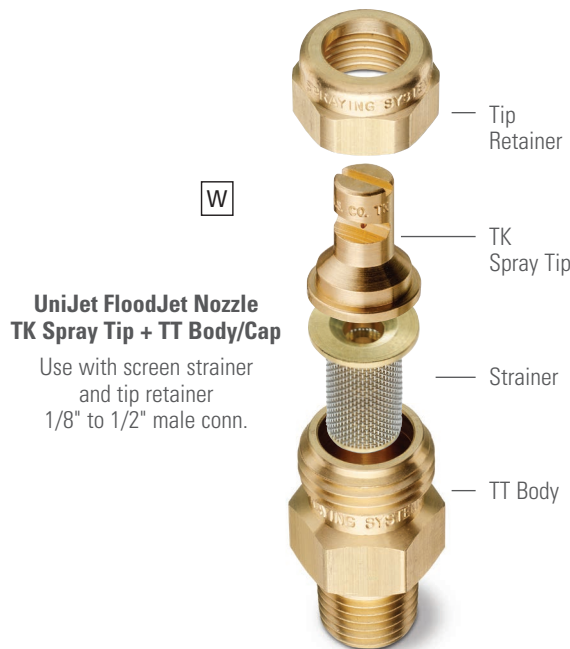

UniJet FloodJet Nozzle
TK Spray Tip + TT Body/Cap

Use with screen strainer
and tip retainer
1/8" to 1/2" male conn.



T Body/Cap
1/8" to 1/2" female conn.
Use with TK spray tip

FOR DETAILED NOZZLE PERFORMANCE DATA, SEE

- Standard Units
- Metric Units

OVERVIEW: FLOODJET NOZZLES

Ideal for: operations requiring wide coverage, uhle box, roll lubrication and chemical showers

- Wide angle, deflected type flat fan spray pattern
- Use where nozzles can be mounted horizontally
- Orifice is protected from damage and is designed to minimize clogging
- Alternate nozzle stand off distance to prevent interference, or use longer nozzle series
- Spray angles from 73° to 153°
- Uniform spray distribution from .04 to 110 gpm (.14 to 410 lpm)
- Operating pressures up to 60 psi (4 bar)

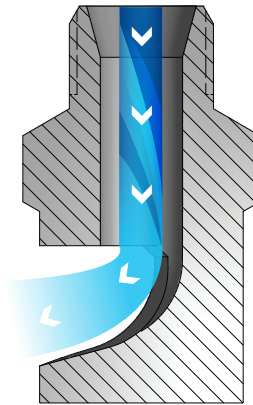

FloodJet Nozzles

As liquid passes through the nozzle, it hits the deflector surface and spreads out to form a flat spray pattern. The distribution is even from the center of the spray. The deflector surface enables the formation of very wide spray angles compared to other flat spray nozzles.

FLOODJET NOZZLE OPTIONS

W



K
1/8" to 1" male conn.
Flow rates below 110 gpm at 60 psi
(410 lpm at 4.1 bar)

W



11499 & 13063
1/8" male conn.
Flow rates below 4.4 gpm at 60 psi
(16.7 lpm at 4.1 bar)

FOR DETAILED NOZZLE PERFORMANCE DATA, SEE
 🔄 Standard Units 🔄 Metric Units

FLATJET® NOZZLES

N NARROW ANGLE SPRAY

FLAT SPRAY

OVERVIEW: FLATJET NOZZLES

Ideal for: edge decks, doctor blade cleaning, save all filter mat peeling and flooded nip showers

- Provides higher impact than other narrow angle nozzles
- Deflected type flat fan spray pattern
- 115220 can be quickly rotated to flush out plugs or debris from orifice and return to a optimal spray pattern
- Spray angles from 15° to 50°
- Uniform spray distribution from .24 to 39 gpm (.91 to 144 lpm)
- Operating pressures up to 150 psi (10 bar)

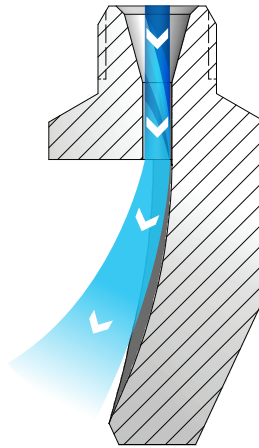

FlatJet Nozzles

As liquid passes through the nozzle, it hits the deflector surface and spreads out to form a flat spray pattern. The distribution is even from the center of the spray. The combination of medium- to large-flow rates and narrow spray angles produce a high impact spray.

FLATJET NOZZLE OPTIONS

N



P

3/8" to 3/4" male conn.
Flow rate from .24 to 39 gpm
(.91 to 144 lpm)

N



P

1/8" to 1/4" male conn.
Flow rate from .24 to 39 gpm
(.91 to 144 lpm)

N



115220 RotoClean® Clean-out Nozzle

3/8" male conn.
Flow rate below 7.7 gpm at 150 psi
(29.15 lpm at 10 bar)

FOR DETAILED NOZZLE PERFORMANCE DATA, SEE

Standard Units Metric Units



FLAT SPRAY

QUICK-CHANGE NOZZLES: QUICKJET®

N NARROW ANGLE SPRAY

OVERVIEW: QUICK-CHANGE NOZZLES: QUICKJET

Ideal for: uhle box, roll lubrication and chemical showers

- High-impact flat spray pattern with narrow spray angle, sharply defined edges and uniform spray pattern
- Quick FlatJet® nozzles feature a one-piece spray tip with the convenience of a quick-connect 1/4 turn installation and automatic spray alignment without the use of tools
- Medium-sized drops
- Large unobstructed flow passage minimizes clogging
- Uniform spray distribution from 3.7 to 59 gpm (14 to 223 lpm)
- Operating pressures up to 150 psi (10 bar)

QUICK-CHANGE QUICKJET NOZZLES OPTIONS



OLPA Spray Tip + QJLA Body
 3/8" to 1/2" female conn.
 Flow rates below 16 gpm at 150 psi
 (61 lpm at 10.3 bar)
 Use with QJLA or QJJLA bodies



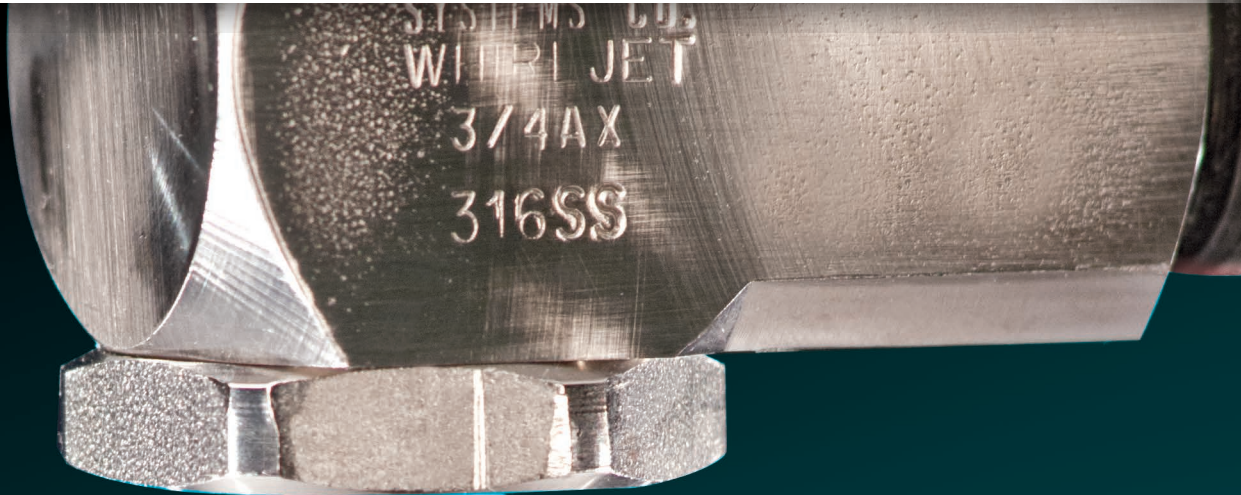

QJJLA Body
 3/8 to 1/2" male conn.

FOR DETAILED NOZZLE PERFORMANCE DATA, SEE
 ↻ Standard Units ↻ Metric Units



HOLLOW CONE NOZZLES

TABLE OF CONTENTS

	PAGE
 WhirlJet® Nozzles	F3
 SpiralJet® Nozzles	F4



HOLLOW CONE

WHIRLJET® AND SPIRALJET® NOZZLES

S STANDARD ANGLE SPRAY | **W** WIDE ANGLE SPRAY

QUICK REFERENCE GUIDE

Model	Connection/Type	Connection Size in.	Flow Rate Range gpm (lpm)	Max. Operating Pressure psi (bar)	Spray Angle	Materials
S STANDARD ANGLE SPRAY W WIDE ANGLE SPRAY						
WhirlJet Nozzles						
AX	F	1/8 to 3/4	.05 to 38 gpm (.19 to 145 lpm)	100 psi (7 bar)	43° to 91° at 10 psi (.7 bar)	Brass, mild steel, 303 stainless steel, 316 stainless steel
BX	M	1/8 to 3/4				
AX-W	F	1/8 to 1/2	.05 to 14.2 gpm (.19 to 54 lpm)		112° to 120° at 10 psi (.7 bar)	
BX-W	M	1/8 to 1/2				
BD	M	3/8 to 1-1/2	.11 to 38 gpm (.41 to 143 lpm)	500 psi (34.5)	30° to 91° at 10 psi (.7 bar)	Brass, 303 stainless steel
BDM	M	3/8	.16 to 9.5 gpm (.61 to 36 lpm)		Nylon, brass cap	
CX	F, Cast	1 to 2-1/2	2.0 to 2362 gpm (7.3 to 9010 lpm)	100 psi (7 bar)	43° to 91° at 7 psi (.5 bar)	Brass, 316 stainless steel
CF	Flange, Cast	4 to 6				
CRC	F, Cast	1-1/4 to 4				
D	M, Cast	1/2 to 3/4			Brass	
AP	F	1/4 to 3/8	.14 to 18.9 gpm (.20 to 15.9 lpm)	100 psi (7 bar)	43° to 91° at 10 psi (.7 bar)	Polypropylene
LAP	F	3/8 to 1/2				
LBP	M	3/8	.20 to 5.4 gpm (.75 to 20 lpm)		112° to 120° at 10 psi (.7 bar)	
AP-W	F	1/4 to 3/8				
LAP-W	F	3/8 to 1/2	.90 to 15.9 gpm (3.4 to 60 lpm)	112° to 120° at 10 psi (.7 bar)		
LBP-W	M	3/8				
S STANDARD ANGLE SPRAY						
SpiralJet Nozzles						
BSJ	M, Hex	1/4 to 4	.49 to 3320 gpm (.20 to 11967 lpm)	400 psi (25 bar)	50° to 180° at 10 psi (.7 bar)	Brass, 316 stainless steel

FOR DETAILED NOZZLE PERFORMANCE DATA, SEE

 Standard Units  Metric Units



OVERVIEW: WHIRLJET NOZZLES

Ideal for: headboxes, foam knockdown and pollution abatement scrubbers

- Hollow cone spray pattern with a circular impact area
- Large, unobstructed flow passages minimize clogging
- Good atomization of liquids at lower pressures
- Removable caps for easy inspection and cleaning on some models
- Slope-bottom design models reduce the drilling effect of the fluid vortex in the fluid chamber and premature wear
- AX and BX nozzles form smaller drops
- CX, CRC and D nozzles feature higher flow rates
- AP, LAP and LBP nozzles are constructed of polypropylene and feature excellent corrosion resistance at temperatures up to 160°F (71°C); patented center post design provides extended wear life of the nozzle
- BD and BDM nozzles are in-line versions; liquid passes through a hole on the inlet side of the nozzle
- Standard and wide spray angles

WhirlJet Nozzles

As liquid enters the nozzle, it passes into a whirlchamber and begins to spin in a circle at high speed. The rotation forces the liquid away from the center toward the edges of the whirlchamber. This causes the liquid to exit the orifice in a hollow cone pattern. Some WhirlJet nozzles have a slope bottom in the whirlchamber that helps extend wear life.

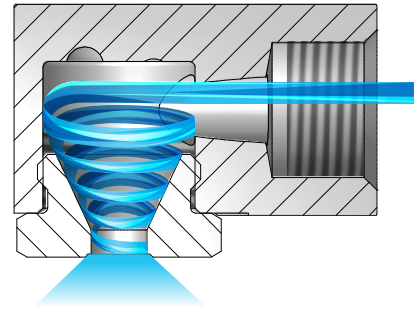

WHIRLJET AX, AX-W, CX, BX, BX-W, CF, CRC AND D NOZZLES

- Spray angles: Standard – 43° to 91° , Wide – 112° to 120°
- Uniform spray distribution:
 - AX and BX nozzles – from .05 to 38 gpm (.19 to 145 lpm)
 - CF, CRC, CX and D nozzles – from 2.0 to 2362 gpm (7.3 to 9010 lpm)
 - AX-W and BX-W nozzles – from .05 to 14.2 gpm (.19 to 54 lpm)
- Operating pressures from 3.0 to 100 psi (.2 to 7 bar)

Contact your local sales engineer for information about junction boxes.

S
W

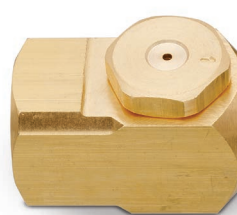

AX and AX-W
Standard angle: 1/8" to 3/4"
Wide Angle: 1/8" to 1/2"
female conn.
Slope-bottom design
Removable cap

S



CX
1" to 2-1/2" female conn.
Slope-bottom design
One-piece cast-type

WHIRLJET OPTIONS

S
W

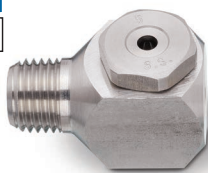

BX and BX-W
Standard angle: 1/8" to 3/4"
Wide angle: 1/8" to 1/2" male conn.
Slope-bottom design
Removable cap

S



CF
4" to 6" flange conn.
Two-piece cast-type

S



CRC
1-1/4" to 4" female conn.
Two-piece cast-type

S



D
1/2" to 3/4" male conn.
One-piece cast-type



HOLLOW CONE

WHIRLJET® & SPIRALJET® NOZZLES

S STANDARD ANGLE SPRAY | **W** WIDE ANGLE SPRAY

WHIRLJET AP, AP-W, BD, BDM, LAP, LAP-W, LBP AND LBP-W NOZZLES

- Spray angles: Standard - 43° to 91°, Wide - 112° to 120°
- Uniform spray distribution:
 - AP, LAP and LBP nozzles – from .14 to 18.9 gpm (.20 to 15.9 lpm)
 - AP-W nozzles – from .20 to 5.4 gpm (.75 to 20 lpm)
 - LAP-W and LBP-W nozzles – from .90 to 15.9 gpm (3.4 to 60 lpm)
 - BD nozzles – from .11 to 38 gpm (.41 to 143 lpm)
 - BDM nozzles – from .16 to 9.5 gpm (.61 to 36 lpm), maximum operating pressure 500 psi (34.5 bar)
- Typical operating pressures from 3.0 to 100 psi (.2 to 7.0 bar)

S
W



AP and AP-W
1/4" to 3/8" female conn.

WHIRLJET OPTIONS

S
W



BD
3/8" to 1-1/2" male conn.
Removable cap

S



BDM
3/8" to 1-1/2" male conn.
Nylon body

S
W



LAP and LAP-W
3/8" to 1/2" female conn.

S
W



LBP and LBP-W
3/8" male conn.

OVERVIEW: SPIRALJET

Ideal for: washing, rinsing and cooling

- Hollow cone spray pattern with a circular impact area
- Minimal clogging – maximum flow through passages of any nozzle of comparable size
- Precision impact blade angles distribute drops and provide excellent coverage
- Compact size

Other sizes and materials available. See Industrial Hydraulic Spray Products, Catalog 75A.

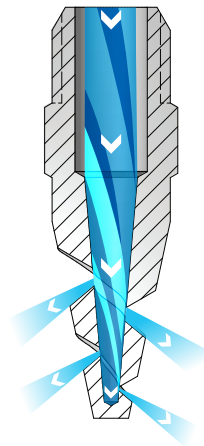

SpiralJet BSJ Nozzles

The liquid entering the nozzle passes through the orifice and exits the voids in the spiral. As it exits, the fluid deflects off the spiral surfaces to form the hollow cone pattern.

SPIRALJET BSJ NOZZLES

- Spray angles: Standard – 50° to 180°
- Uniform spray distribution from .49 to 1126 gpm (2.0 to 4262 lpm)
- Operating pressures up to 400 psi (25 bar)

S









BSJ – 1/4" to 2" male conn.
Threaded/Hex. body style/brass



AUTOMATIC AND AIR ATOMIZING NOZZLES

TABLE OF CONTENTS

	PAGE
 Automatic Nozzles Introduction	G2
 Electrically-actuated PulsaJet® Hydraulic Nozzles	G4
 Electrically-actuated PulsaJet Air Atomizing Nozzles	G5
 Air-actuated Air Atomizing Nozzles	G6
 J and JJ Series Air Atomizing Nozzles	G8
 Fogging and Humidification Nozzles	G10
 Other Fogging and Humidification Options	G12



PRECISE CONTROL & EFFICIENT SPRAY APPLICATION

INTRODUCTION

If your application requires precise control of intermittent spraying, you'll find many product options in this section. Both electrically-actuated and air-actuated nozzles are available. Models which atomize flow using liquid pressure only or using compressed air are both offered. To optimize the performance of automatic spray nozzles, consider adding an AutoJet® Spray Controller.

THE BENEFITS OF SPRAY CONTROL

Controlling automatic nozzles with one of our AutoJet spray controllers maximizes nozzle performance and enables automation of spray system operation. Automated spray control can help improve accuracy, reduce waste and overspray, boost production time and allow workers to be deployed to other tasks.

More specifically, with AutoJet Spray Control you can:

- Adjust flow rate for line or machine speed variations
- Precisely control liquid pressure, atomizing air pressure and fan air pressure to optimize spray performance
- Notify operators or shut down on specified faults
- Integrate control of your spray application with existing plant control

AUTOJET SPRAY CONTROLLERS

All of our automatic spray nozzles are compatible with our spray controllers. For operations like coating, moisturizing and adding costly chemicals, spray control can dramatically improve product or process quality and help save tens of thousands of dollars annually.



If your operation requires any of the following, the spray control should be considered.

- Consistent, uniform coverage
- Precise spray placement on the target
- Intermittent spraying
- The use of costly coatings or chemicals
- The ability to adjust spray performance based on line speed
- Monitoring and supervision to ensure proper spray performance

Our AutoJet Spray Controllers range from basic to advanced.

- **AutoJet Model 1550+ Modular Spray System** with basic on/off spray control for up to eight automatic nozzles
- **AutoJet Model 2008+ Spray Control Panel** provides timing and sensor control for up to 16 nozzles
- **AutoJet Model 2250+ Spray Control Panel** with sophisticated real-time monitoring and closed-loop control for up to 16 nozzles



AUTOMATIC NOZZLES INTRODUCTION

AUTOMATIC & AIR ATOMIZING



PRECISION SPRAY CONTROL (PSC)

PulsaJet® automatic spray nozzles paired with an AutoJet® spray controller provide Precision Spray Control (PSC) to ensure coatings are applied uniformly and with minimal waste.

The benefits of PSC are many:

- Automatically maintains consistent coating weight even when line speed changes
- Reduces product scrap caused by over- or under-application of the sprayed solution
- Reduces the use of costly coatings by applying the proper coating volume directly on the target
- Eliminates maintenance time to clean overspray from equipment and/or floor due to over-application
- Improves worker safety by minimizing misting
- Eliminates the need for compressed air in some operations

HOW PRECISION SPRAY CONTROL WORKS

Electrically-actuated spray nozzles are turned on and off very quickly to control flow rate. This cycling is so fast that the flow often appears to be constant.

With traditional nozzles, flow rate adjustments require a change in pressure. Changing pressure also changes the nozzle's spray angle/coverage and drop size. With PSC, pressure remains constant enabling flow rate changes without changes in spray performance.

NOZZLES SPRAYING 90% OF THE TIME

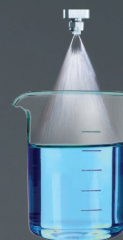
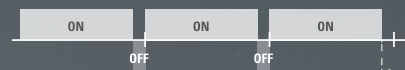

NOZZLES SPRAYING 50% OF THE TIME

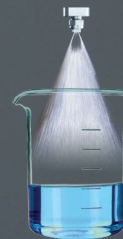
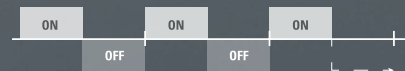

NOZZLES SPRAYING 25% OF THE TIME

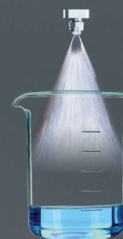

TYPICAL APPLICATIONS:

- Adhesives/glue
- De-ionized water
- Dyes and inks
- Enzymes
- Fragrances/aromas
- Lotions
- Lubricants/release agents/silicone

LEARN MORE & SEE HOW PSC WORKS:
spray.com/psc

OVERVIEW: ELECTRICALLY-ACTUATED PULSAJET HYDRAULIC NOZZLES

- Hydraulic atomizing nozzles use only liquid pressure as the force for atomization
- Electrically-actuated nozzles provide the fastest cycling of any automatic nozzles – up to 25,000 cycles per minute
- When using a PulsaJet® series nozzle and an AutoJet® spray controller, Precision Spray Control (PSC) can provide:
 - Consistent application rates at varying line speeds
 - Low flow rates comparable to air atomizing nozzles eliminating the use of compressed air in some operations
- Dozens of UniJet® spray tips are available for PulsaJet nozzles in a wide variety of flow rates. Auto-alignment of spray tips is offered on some models

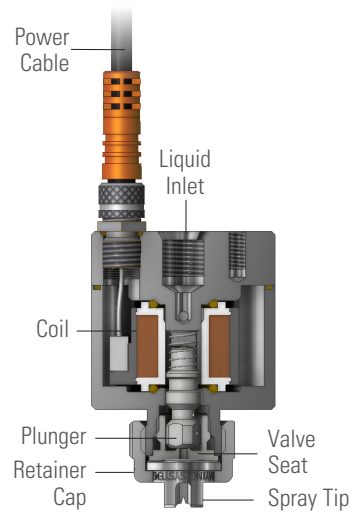

PulsaJet 10000 Series Nozzle

The compact design and simple mounting options for PulsaJet nozzles enable them to be easily integrated into most production areas. Wear parts for all PulsaJet nozzles are easily accessible to minimize routine maintenance time.

ELECTRICALLY-ACTUATED HYDRAULIC PULSAJET NOZZLE OPTIONS

AA10000AUH-03

- Typical flow range: 0.0017 - 0.47 gpm (0.006 - 1.8 lpm)
- Construction: stainless steel, Viton® or EPDM seals, PPS and PEEK

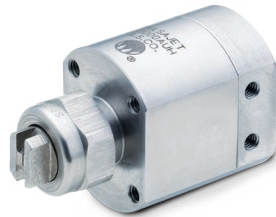

AA10000AUH-10

- Typical flow range: 0.02 - 1.6 gpm (0.075 - 6.1 lpm)
- Highest capacity PulsaJet nozzle
- Construction: stainless steel, Viton® or EPDM seals, PPS and PEEK

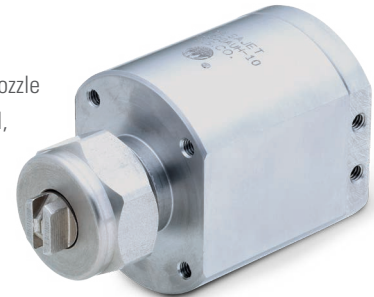

QUICK REFERENCE GUIDE

Model/Type	Connection Size/Type in.	Max Liquid Pressure psi (bar)	Power Vdc (Amp)	Max Flow gpm (lpm)	Max Liquid Temp °F (°C)	Max Speed cpm	Spray Tips/ Set-ups
AA10000AUH-03 Hydraulic	1/8	100 (7)* 250 (17) w/ AutoJet® 2008+ spray controller	24 (0.36)	0.47 (1.8)	200 (93)	10,000 (15,000 with AutoJet 2008+ controller)	TPU
AA10000AUH-10 Hydraulic	1/8 F	100 (7)	24 (1.05)	1.6 (6.1)	150 (66)	5,000	TPU

*Higher pressure possible with AutoJet 2008+ spray controller

ELECTRICALLY-ACTUATED PULSAJET® AIR ATOMIZING NOZZLES

AUTOMATIC & AIR ATOMIZING

OVERVIEW: ELECTRICALLY-ACTUATED PULSAJET AIR ATOMIZING NOZZLES

- Electrically-actuated nozzles provide the fastest cycling of any automatic nozzles – up to 10,000 cycles per minute
- Compressed air is used as the force for atomization, producing the smallest drop sizes and lowest possible flow rates
- Hundreds of air atomizing set-ups are available for a wide variety of spray patterns and flow rates
- Precision Spray Control using an AutoJet® Spray Controller ensures consistent flow rates at varying line speeds
- Many options are available for convenient mounting, clean-out needles, food grade materials of construction and more

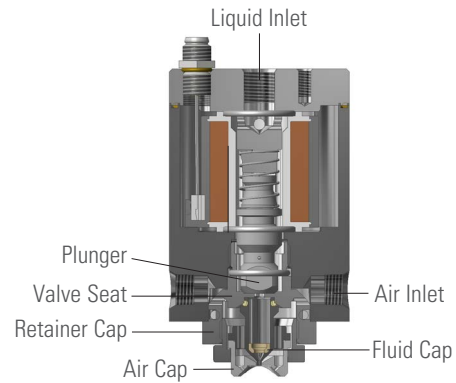

AA10000JAU Nozzle

The compact design and simple mounting options for PulsaJet nozzles enable them to be easily integrated into most production areas. Wear parts for all PulsaJet nozzles are easily accessible to minimize routine maintenance time.

ELECTRICALLY-ACTUATED AIR ATOMIZING PULSAJET NOZZLE OPTIONS

AA10000JJAU

- Rear liquid inlet; side air inlet
- Flow rates up to 0.16 gpm (0.61 lpm)
- Stainless steel, PPS and PEEK construction with Viton® or EPDM seals
- All wear parts accessible from the front of the nozzle without disturbing mounting and air/liquid/electrical connections
- For use with standard 1/8JJ air caps and 1/8JJ fluid caps (maximum size 2850)



AA10000JAU-10

- Rear liquid inlet; side air inlet
- Flow rates up to 0.75 gpm (2.84 lpm)
- Stainless steel, PPS and PEEK construction with Viton or EPDM seals
- All wear parts accessible from the front of the nozzle without disturbing mounting and air/liquid/electrical connections
- For use with standard 1/4J air caps and threadless 1/4J fluid caps (maximum size 80100)



QUICK REFERENCE GUIDE

Model/Type	Connection Size/Type in.	Max Liquid Pressure psi (bar)	Max Air Pressure psi (bar)	Power Vdc (Amp)	Max Flow gpm (lpm)	Max Liquid Temp °F (°C)	Max Speed cpm	Spray Tips/ Set-ups
AA10000JJAU Air Atomizing	1/8 (air and liquid)	100 (7)* 250 (17) w/AutoJet 2008+ spray controller	100 (7)	24 (0.36)	0.16 (0.61)	200 (93)	10,000	JJ set-ups
AA10000JAU-10 Air Atomizing	1/8 (air and liquid)	100 (7)	100 (7)	24 (1.05)	0.75 (2.84)	200 (93)	5,000	Threadless 1/4J set-ups

*Higher pressure possible with AutoJet 2008+ spray controller

FOR DETAILED NOZZLE PERFORMANCE DATA, SEE AIR ATOMIZING & AUTOMATIC SPRAY NOZZLES, CAT 76

OVERVIEW: AIR-ACTUATED AIR ATOMIZING NOZZLES

Ideal for: coating, moisturizing and marking

- Compressed air is used to control air cylinder operation for accurate intermittent spraying (up to 180 cycles per minute) and also for liquid atomization
- Wide variety of nozzle bodies is available for convenient mounting and positioning
- Models available with clean-out needles, shut-off needles, swivels and strainers to optimize performance
- Liquid lines can be pressure-fed, siphon-fed or gravity-fed
- Spray set-ups, consisting of an air cap and a fluid cap can mix the fluids either internally or externally to produce a fine spray pattern
- Dozens of Drip Free™ air atomizing spray set-ups available for a wide range of flow capacity and spray patterns

For a wide range of options, such as clean-out needles, body styles and spray tips, see Automatic and Air Atomizing Spray Nozzles, Cat. 76.

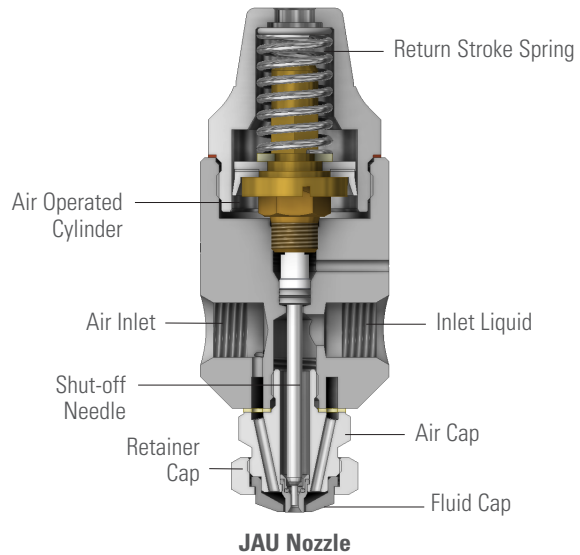

JAU Nozzle
JAU air atomizing nozzles mix compressed air and liquid to form a finely atomized spray. An air-actuated internal cylinder with return stroke spring cycles the nozzle up to 180 times per minute.

AIR-ACTUATED AIR ATOMIZING NOZZLE OPTIONS

1/4JAU

- Flow rates up to 1.2 gpm (4.5 lpm)
- Drip Free™ set-ups provide complete shut-off
- Nickel-plated brass or stainless steel construction



1/8JJAU

- Compact design ideal where space is limited
- Flow rates up to 0.55 gpm (2.1 lpm)
- Drip Free™ set-ups provide complete shut-off
- Nickel-plated brass or stainless steel construction



FOR DETAILED NOZZLE PERFORMANCE DATA,
SEE AIR ATOMIZING & AUTOMATIC
SPRAY NOZZLES, CAT 76

AIR-ACTUATED AIR ATOMIZING NOZZLES

AUTOMATIC & AIR ATOMIZING

AIR-ACTUATED AIR ATOMIZING NOZZLE OPTIONS

VAU/VMAU Variable Spray

- Flow rates up to 1.22 gpm (4.62 lpm)
- Stainless steel construction
- Independent control of liquid, fan air and atomizing air provides maximum control of spray coverage
- Dual liquid inlets allow recirculating of sprayed fluid
- VMAU offers modular construction for reduced maintenance time



10535-1/4J

- Flow rates up to 1.2 gpm (4.5 lpm)
- Self-contained air cylinder provides controlled intermittent spraying
- Drip Free™ set-ups provide complete shut-off
- Nickel-plated brass or stainless steel construction
- Also available in ½" and 1" sizes



QUICK REFERENCE GUIDE

Model	Connection Size in.	Max Liquid Pressure psi (bar)	Max Air Cylinder Pressure psi (bar)	Max Flow gpm (lpm)	Max Liquid Temp °F (°C)	Max Speed cpm	Spray Set-ups
1/4JAU	1/4 (air and liquid)	125 (8.6)	30 (2.1)	1.2 (4.5)	400 (204)	180	1/4J
1/8JJAU	1/4 (air and liquid)	125 (8.6)	30 (2.1)	0.55 (2.1)	400 (204)	180	1/8JJ
1/8VAU Air Atomizing	Variable Spray	90 (6.2)	35 (2.4)	0.83 (3.15)	200 (93)	180	SUV
1/4VMAU Air Atomizing	1/4, or sanitary flange (atom. air, fan air and liquid)	90 (6.2)	35 (2.4)	1.22 (4.62)	200 (93)	180	SUVM
10535-1/4J Air Atomizing	1/4 (air and liquid)	125 (8.6)	30 (2.1)	1.2 (4.5)	400 (204) liquid 150 (66) air	180	1/4J

FOR DETAILED NOZZLE PERFORMANCE DATA, SEE AIR ATOMIZING & AUTOMATIC SPRAY NOZZLES, CAT 76



OVERVIEW: J AND JJ SERIES AIR ATOMIZING NOZZLES

Ideal for: coating, moisturizing and marking

- Liquid and compressed air enter the nozzle body and are mixed by the spray set-up to produce a finely atomized spray pattern
- Spray set-ups, consisting of an air cap and a fluid cap, can mix the fluids either internally or externally
- Hundreds of spray set-ups are available to produce cone and flat spray patterns
- A wide variety of nozzle bodies are available for convenient mounting and positioning
- JJ compact nozzle bodies are available for applications where space is limited
- Models available with clean-out needles, shut-off needles swivels and strainers to optimize performance

For a wide range of options, such as clean-out needles, body styles and spray tips, see Automatic and Air Atomizing Spray Nozzles, Cat. 76.

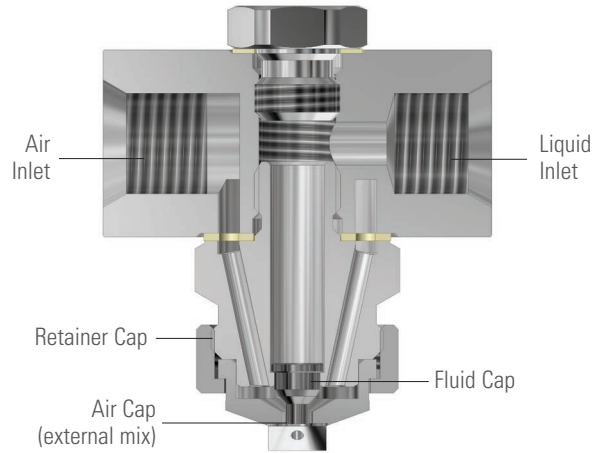

1/4J Nozzle

Air and liquid enter the air atomizing nozzle body and are combined by the spray set-up to generate finely atomized droplets.

1/8J AND 1/4J SERIES NOZZLES

- J Series nozzles consist of a nozzle body and a spray set-up
- A wide variety of spray set-ups are available with flow rates up to 72 gph (273 lph) in various spray patterns.
- Basic 1/8J and 1/4J bodies have liquid and air inlets on opposing sides of the nozzle bodies. Nozzle bodies include a removable plug so needle assemblies can be added in the future
- Nickel-plated brass or stainless steel construction

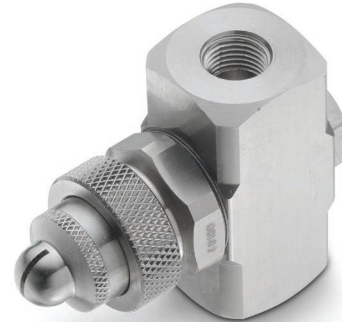

1/8J and 1/4J Nozzles

1/8J AND 1/4J NOZZLE OPTIONS

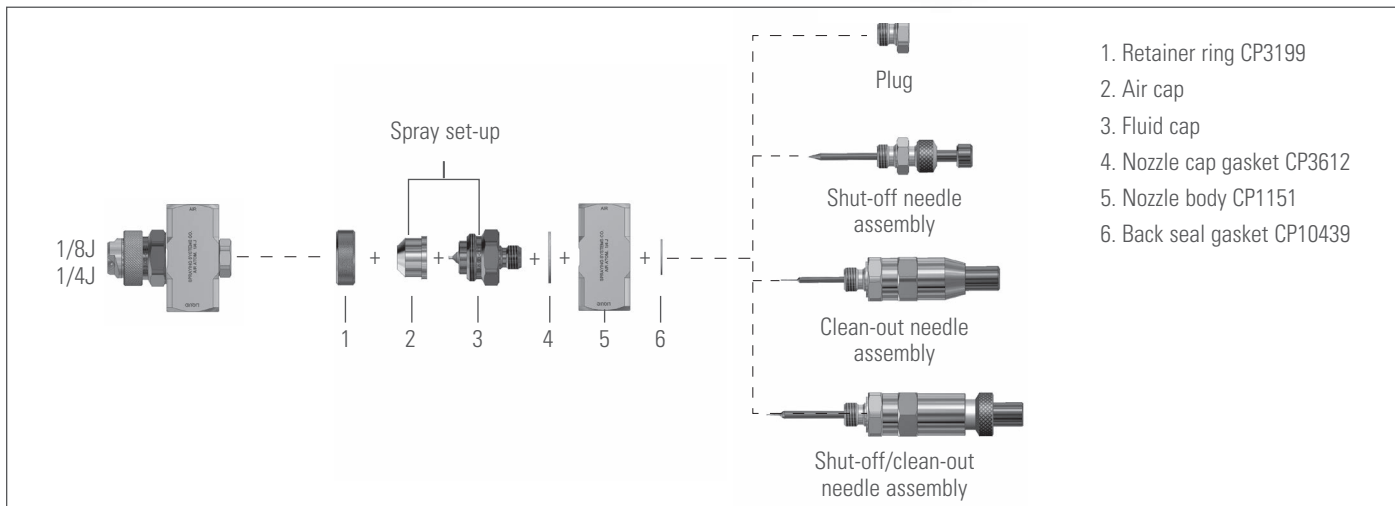

J AND JJ SERIES AIR ATOMIZING NOZZLES

AUTOMATIC & AIR ATOMIZING

1/8JJ SERIES NOZZLES

- Compact JJ Series nozzles consist of a nozzle body and a spray set-up
- A wide variety of spray set-ups are available with flow rates up to 33 gph (126 lph) in various spray patterns
- 1/8JJ bodies have liquid and air inlets on opposing sides of the nozzle bodies. Nozzle bodies include a removable plug so needle assemblies can be added in the future
- Nickel-plated brass or stainless steel construction



1/8JJ Nozzle

JJ SERIES SPRAY NOZZLE OPTIONS

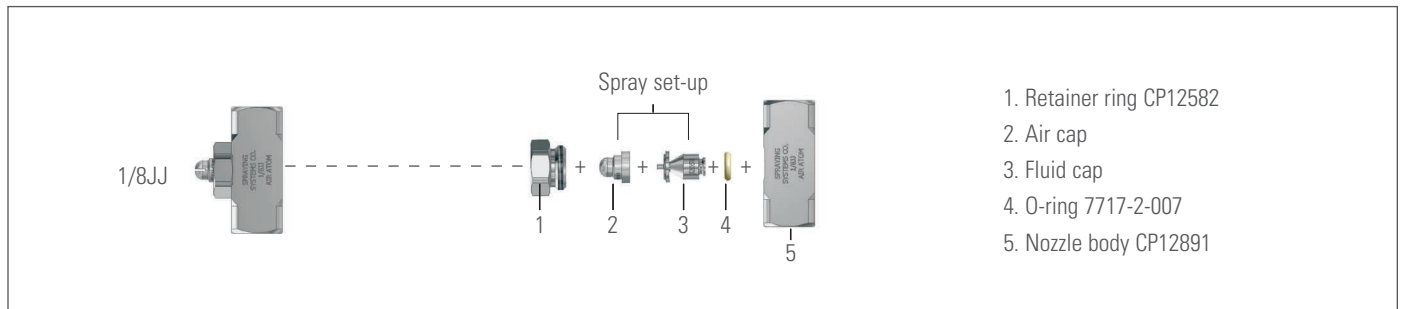

QUICK REFERENCE GUIDE

Model	Connection Size in.	Max Flow gph (lph)	Max Liquid Temp °F (°C)	Spray Set-ups
1/8J and 1/4J	1/8 to 1/4	72 (273)	400 (204)	1/8J and 1/4J
1/8JJ	1/8	33.2 (126)	400 (204)	1/8JJ

FOR DETAILED NOZZLE PERFORMANCE DATA, SEE AIR ATOMIZING & AUTOMATIC SPRAY NOZZLES, CAT 76



OVERVIEW: FOGGING & HUMIDIFICATION

- Liquid and compressed air are mixed to produce a finely atomized spray for rapid evaporation and efficient humidification
- Drop size may be controlled by adjusting air and water pressure to create a wet or a dry fog, depending on application requirements
- Several configurations are available to produce flow rates up to 72 gph (272 lph)
- Nozzles are available that operate using normal municipal water pressure – without the use of high-pressure pumps
- A variety of nozzle bodies are available for convenient mounting and positioning

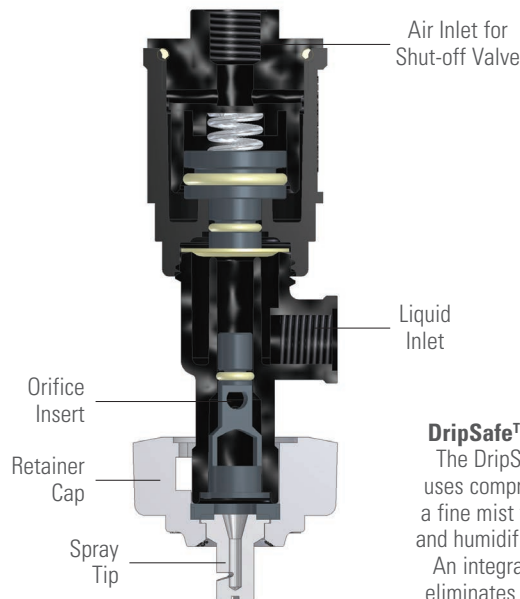

DripSafe™ AirJet® Fogger
The DripSafe AirJet Fogger uses compressed air to create a fine mist for fogging, cooling and humidification applications. An integrated shut-off valve eliminates unwanted dripping from the nozzle.

DRIPSAFE™ AIRJET® FOGGER NOZZLES

- High quality, cost-efficient dry fog with average drop size of fifteen microns or less
- Drop size can be adjusted by changing the ratio of compressed air to water
- High-volume/high-efficiency air atomization is ideal for large/open structures and areas with high air exchange rates
- DripSafe air-actuated shut-off valve prevents liquid flow until air pressure at the nozzle is sufficient for fine atomization
- Flat spray tip has a large orifice that reduces clogging
- Spray set-up and built-in strainer are quickly removed by hand if cleaning is required
- Can use PVC pipe and low-pressure air tubing
- Operates using normal pressures found in municipal water systems, eliminates the need for expensive, high-pressure hydraulic pumps
- Spray tip is brass; valve and body are polymer
- Minimum air pressure range of 25 to 35 psi (1.7 to 2.5 bar)



45265 AirJet Fogger –
Threaded 1/4" NPT or BSPT connection

45269 AirJet Fogger –
Split-eyelet design provides fast installation of the nozzle onto the liquid supply pipe. No additional pipe fittings are required. Pipe cutting, threading and brazing are eliminated.

FOGGING AND HUMIDIFICATION NOZZLES

AUTOMATIC & AIR ATOMIZING

YMF MINIFOGGER® III

- High quality, cost-efficient dry fog with drop sizes seven to ten microns
- Compact design of 4.5" (115 mm) tall ideal for humidification applications with limited space
- Can be easily installed on a header, wall or ceiling
- Available with up to four stainless steel spray nozzle set-ups, each with automatic spray pattern alignment
- Choice of spray set-ups provide flow rates ranging from 0.24 to 1.22 gph (0.9 to 4.6 l/hr)
- 0.46 lbs. (210 g) for single spray set-up type; 0.55 lbs. (250 g) for multiple four set-up types
- Body, retainer cap and tank constructed of corrosion-resistant polypropylene with stainless steel air and water inlet connections
- Materials compatible with deionized water
- Easy to maintain – no tools required



QUICK REFERENCE GUIDE

Product Number	Connection Type	Max Flow
45265 DripSafe™ AirJet® Fogger	.290" (7.4 mm) hose shank for 1/4" air hose or tubing (atomizing air) 1/4" (shut-off valve air) 1/4" (liquid)	4.5 gph (17.0 lph)
45269 DripSafe AirJet Fogger	.290" (7.4 mm) hose shank for 1/4" air hose or tubing (atomizing air) 1/4" (shut-off valve air) Split-eyelet connection for 1/2", 3/4" or 1" liquid supply pipe	4.5 gph (17.0 lph)
YMF MiniFogger III	1/4" (air) 1/8" (liquid)	1.22 gpm (4.6 lpm)
1/4JH	1/4" (air and liquid)	72 gph (272 lph)
1/4JT	1/4" (air and liquid)	11.6 gph (43.9 lph)

FOR DETAILED NOZZLE PERFORMANCE DATA,
SEE AIR ATOMIZING & AUTOMATIC
SPRAY NOZZLES, CAT 76

OTHER FOGGING AND HUMIDIFICATION OPTIONS

1/4JH Nozzle

- Provides automatic, efficient humidity control with low installation and operating costs
- Produces a fine atomized spray for rapid evaporation and efficient humidification
- Nozzles operate either with compressed air drawing water from the float box, by siphon action, or with water delivered to the nozzle under pressure



1/4JT Nozzle

- Provides automatic, efficient humidity control with low installation and operating costs
- Produces a fine atomized spray for rapid evaporation and efficient humidification
- Suitable for use in systems where water is under pressure
- Built-in strainer for air and water plus a ball check valve in the water line



45400 Humidification Unit

- A self-contained humidifier suitable for use with deionized water
- Easy to install on a wall or for use in non-ducted applications
- Air regulator and gauge, 24VDC air control solenoid and air line filter are included
- Wall-mounting bracket is also provided
- For each spray set-up, water capacity ranges from 2.7 lbs/hr at 10 psi (0.7 bar) air to 6.5 lbs/hr at 60 psi (4 bar) air
- 9.7 lbs. (4.4 kg)



55089 Humidistat

- Quick relative humidity LCD readouts from 1% to 99% with repeatability of +/-5%
- Operating temperature range 32°F to 160°F (0°C to 71°C)
- 24V (DC or AC)



FOR DETAILED PERFORMANCE DATA,
SEE AUTOMATIC AND AIR ATOMIZING
SPRAY NOZZLES, CAT. 76



CHEST CLEANERS

TABLE OF CONTENTS

	PAGE
 TankJet® Tank and Chest Cleaners	H2
 Strainers	H8



OVERVIEW: TANKJET TANK AND CHEST CLEANERS

Ideal for: pulp chests, headboxes, broke storage chests, tile-lined stock chests, machine chests, low-D chests, HY-D chests, small vessels, totes and more

- Consistent, thorough cleaning of tanks and chests using less water and chemicals than manual or fill and drain methods
 - Eliminates the need to use costly contract cleaning services or having workers enter large chests
 - Choose from high-impact, motor- or fluid-driven machines; constant or variable speed rotating units; and stationary spray nozzle and spray balls
 - Wide range of operating pressures, spray coverages, connections, materials, nozzle hubs and more
 - Units available for cleaning chests and tanks up to 100 ft. (3.5 m) in dia.
- Some of the most commonly used products in mills are featured here. For complete specifications and performance data, see TankJet Tank Cleaning Products, Cat. 75TJ.**

TANKJET TANK AND CHEST CLEANER OPTIONS

TankJet 360

For high-impact chest cleaning or tanks up to 100 ft. (30.5 m) in diameter

- Provides consistent, high-impact, high-efficiency cleaning over the entire pressure range for short cycle times
- Can be used for high-concentration chemical recirculation cleaning or low pressure, high-volume cleaning
- Nozzles rotate 360° in horizontal and vertical planes, creating a crisscrossing pattern to thoroughly clean tanks and remove the stickiest of residues
- Standard clutch version permits easy nozzle hub rotation by hand for insertion and removal from tank; optional pin version for permanent or CIP installations; optional external, self-rinsing nozzles are available for both pin and clutch versions
- Built-in strainer minimizes clogging and extends wear life; user-serviceable for easy maintenance



TankJet AA290

For high-impact chest cleaning or tanks up to 100 ft. (30.5 m) in diameter

- Dependable, durable motor-driven units provide consistent, high-impact, 360° cleaning to remove the most stubborn residues
- Construction features corrosion-resistant 316 stainless steel with PTFE fluoropolymer resin seals; having the motor positioned outside the tank ensures longer life and fewer failures due to exposure to harmful cleaning solutions
- 55430 series solid stream nozzles provide optimum impact and have removable stabilizer vanes for easy maintenance
- Choice of:
 - CE-rated air (AG) or explosion-proof (E-EP) electric motor
 - Two- or four-nozzle hub
 - Extension lengths from 3 ft. (0.9 m) up to 10 ft. (3.0 m)



TANKJET® TANK AND CHEST CLEANERS

CHEST CLEANERS

TankJet 78

For high-impact chest cleaning or tanks up to 45 ft. (13.7 m) in diameter

- High-impact, 360° cleaning ensures tank cleanliness and results in shorter cleaning cycles and reduced use of water and chemicals
- Fast and easy maintenance without tools
- Easy retrofit for spray balls
- Choice of two- or four-nozzle configurations and inlet connection size



TankJet AA190

For high-impact chest cleaning or tanks up to 40 ft. (12.2 m) in diameter

- Versatile, high-impact tank cleaner provides efficient, consistent, reliable cleaning with virtually no maintenance
- Lightweight units can be installed permanently or easily moved from tank to tank
- Component and configuration options allow easy customization to meet the needs a variety of cleaning operations. Choice of:
 - Variable speed, CE-approved air (AG), electric (E) or explosion-proof (E-EP) electric motors
 - Operational pressure range from 100 up to 1000 psi (7 to 69 bar)
 - 360° or 180° coverage
 - Extension lengths from 4 in. (1.2 m) to 10 ft. (3.0 m)

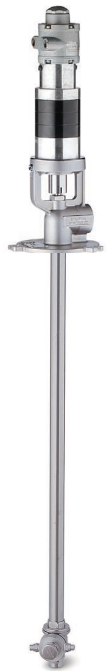

TankJet 27500

For chests up to 25 ft. (7.6 m) in diameter

- Excellent cleaning and rinsing; reactionary force of cleaning liquid drives rotation of nozzles
- Spray angles range from 180° to 360° and can be used to clean specific areas or the entire tank interior
- Made of corrosion- and chemical-resistant PTFE fluoropolymer resin
- Delivers greater impact than static spray balls



TankJet 6353









For rinsing chests up to 10 ft. (3.0 m) in diameter

- Simple and reliable with no moving parts
- Individual nozzles (13 total) can be replaced with plugs to provide specific cleaning coverages
- Nozzles are easily removed for cleaning and inspection
- Can be installed in any position



FOR DETAILED NOZZLE PERFORMANCE DATA, SEE TANKJET® TANK CLEANING PRODUCTS, CAT. 75TJ









QUICK REFERENCE GUIDE

Nozzle	Max. Tank Dia. ft. (m)	Operating Principle	Flow Rate gpm (lpm)	Operating Pressure psi (bar)	Spray Coverage	Min. Tank Opening in. (mm)	Max. Temp. °F (°C)	Typical Applications
TankJet 360 	100 (30.5)	Fluid-driven turbine	30 to 300 (114 to 1136)	40 to 350 (2.8 to 24.1)	360°	6.25 (159) for 2 nozzle; 10.25 (260) for 3 nozzle	250 (121)	Cleaning large stock chests and tanks in the mill
TankJet AA290 		Motor-driven	24 to 284 (91 to 1075)	50 to 250 (3.4 to 17.2)	360°	7.25 (184) for 2 nozzle; 8.25 (210) for 4 nozzle	200 (93)	Cleaning large stock chests and tanks with stubborn residues
TankJet 180 	80 (24.4)	Fluid-driven turbine	30 to 300 (114 to 1136)	40 to 350 (2.8 to 24)	180°	12.25 (311)	250 (121)	Cleaning large open top stock chests and vessels
TankJet 80 	50 (15.2)	Fluid-driven turbine	53 to 142 (200 to 538)	60 to 200 (4.1 to 13.8)	360°	6.5 (165) for 2 nozzle; 12.5 (318) for 3 nozzle	250 (121)	Cleaning large stock chests and tanks with stock buildup
TankJet 78 & 78D 	45 (13.7)	Fluid-driven turbine	65 to 165 (246 to 625)	25 to 100 (1.7 to 6.9)	360°	TJ78: 5.75 (146) TJ78D: 7.63 (194)	200 (93)	Rinsing medium-size vessels which require more sanitary designs
TankJet 65 & 65HT 	40 (12.2)	Fluid-driven turbine	30 to 150 (114 to 568)	50 to 150 (3.4 to 10.3)	360°	7.5 (190)	TJ65: 250 (121) TJ65HT: 500 (260)	Quick cleaning of large tanks
TankJet AA190 		Motor-driven	3.1 to 44 (11.8 to 167)	100 to 1000 (6.9 to 69)	180°, 360°	3.75 (95) for 360°; 4.5 (114.3) for 180°	200 (93)	Cleaning different size tanks with varying residues
TankJet YMD3 	30 (9.1)	Motor-driven	8.6 to 37.5 (32.6 to 142)	725 to 4350 (50 to 300)	360°	3.75 (95)	176 (80)	High-pressure cleaning









TANKJET® TANK AND CHEST CLEANERS

CHEST CLEANERS

QUICK REFERENCE GUIDE

Nozzle	Max. Tank Dia. ft. (m)	Operating Principle	Flow Rate gpm (lpm)	Operating Pressure psi (bar)	Spray Coverage	Min. Tank Opening in. (mm)	Max. Temp. °F (°C)	Typical Applications
 <p>TankJet 75</p>	30 (9.1)	Fluid-driven turbine	15.0 to 33 (57 to 125)	75 to 300 (5.2 to 21)	360°	3.75 (95)	250 (121)	Quick cleaning of large tanks
 <p>TankJet 27500 & 27500-R</p>	10 to 25 (3.0 to 7.6)	Fluid-driven reactionary force	4.0 to 224 (15.3 to 850)	10.0 to 50 (0.7 to 3.4)	180° up/down, 270° up/down, 360°	2 to 7 (51 to 178)	200 (93)	Cleaning with corrosive chemicals or in corrosive environment
 <p>TankJet 16</p>	24 (7.2)	Fluid-driven turbine	36 to 76 (136 to 288)	50 to 200 (3.4 to 13.8)	180° up/down, 270° down, 360°	3 (76)	250 (121)	Cleaning medium-size vessels with small openings
 <p>TankJet 28500 & 28500-R</p>	18 (5.5)	Fluid-driven reactionary force	9.0 to 78.3 (34 to 296)	10.0 to 50 (0.7 to 3.4)	180° up/down, 270° up/down, 360°	2.5 to 4 (64 to 102)	200 (93)	Rinsing medium-size vessels which require more sanitary designs
 <p>TankJet 12900</p>	18 (5.5)	Fixed stationary	72 to 385 (280 to 1470)	20 to 50 (1.4 to 3.4)	360° and custom spray angles	10 (254)	212 (100)	Rinsing medium headboxes or machine washdown
 <p>TankJet AA090</p>	16 (4.9)	Motor-driven	1.5 to 7.3 (5.7 to 28)	100 to 500 (6.9 to 34.5)	360°	2.3 (59)	200 (93)	High-impact cleaning of medium-size chests
 <p>TankJet D26984 & D40159</p>	10 to 16 (3.0 to 4.9)	Fluid-driven constant speed	3.2 to 19.8 (12.0 to 75)	30 to 90 (2.1 to 6.2)	65° down, 120° down, 180° up/down, 260° up/down, 360°	Thread: 2.25 (56) CIP version: 4 (102)	160 (70)	Cleaning and rinsing of medium-size vessels requiring different spray coverages
 <p>TankJet D41800E</p>	10 to 16 (3.0 to 4.9)	Fluid-driven constant speed	3.0 to 22.8 (11.0 to 86)	30 to 90 (2.1 to 6.2)	360°	1.25 (32)	265 (130)	Cleaning medium-size vessels requiring sanitary type designs





QUICK REFERENCE GUIDE

Nozzle	Max. Tank Dia. ft. (m)	Operating Principle	Flow Rate gpm (lpm)	Operating Pressure psi (bar)	Spray Coverage	Min. Tank Opening in. (mm)	Max. Temp. °F (°C)	Typical Applications
TankJet D41990 	6.5 to 16 (2.0 to 4.9)	Fluid-driven reactionary force	2.4 to 37.4 (9.0 to 141)	15.0 to 60 (1.0 to 4.1)	180° up/down, 360°	Thread: 1 to 1.5 (25 to 38) CIP version: 2 to 4 (51 to 102)	265 (130)	Cleaning small to medium chests in high-risk environments
TankJet 9 A, B & C 	6 to 16 (1.8 to 4.9)	Fluid-driven reactionary force	1.3 to 38 (4.9 to 144)	10.0 to 120 (0.7 to 8.3)	2 x 175°, 360°	TJ9-A: 1.25 (32) TJ9-B: 1.5 (38) TJ9-C: 1.75 (44)	190 (88)	Cleaning small to medium chests with very small tank openings
TankJet 63225 	13 (4.0)	Fixed stationary	22 to 51 (83 to 192)	15.0 to 40 (1.0 to 2.8)	360°	1.5 to 4 (38 to 102)	400 (204)	Rinsing medium-size vessels which require sanitary-type designs
TankJet 14 & 19 	12 (3.7)	Fluid-driven turbine	10.0 to 30 (38 to 114)	50 to 200 (3.4 to 13.8)	180° up/down, 270° down, 360°	2 (51)	250 (121)	Rinsing medium-size chests with medium impact
TankJet 6353 & 6353-MFP 	10 (3.0)	Fixed stationary	8.9 to 80 (35 to 301)	20 to 50 (1.4 to 3.4)	360°	6 (152)	212 (100)	Rinsing smaller tanks or headboxes
TankJet 18250A 	8 (2.4)	Fluid-driven reactionary force	10.5 to 55 (48 to 205)	10.0 to 60 (0.7 to 4.1)	360°	2.38 (60)	350 (177)	Cleaning small vessels
TankJet D41892 	6.5 (2.0)	Fluid-driven reactionary force	4.0 to 7.5 (15.9 to 29)	20 to 70 (1.4 to 4.8)	360°	1.5 (37)	160 (70)	Cleaning small tanks in high-risk environments
TankJet M60 	5 (1.5)	Motor-driven	1.1 to 10.1 (4.2 to 38)	100 to 1000 (6.9 to 69)	360°	1.75 (44.5)	180 (82)	Mobile cleaning of multiple totes and open-bottom vessels
TankJet D26564 		Fluid-driven reactionary force	2.4 to 5.4 (9.0 to 20.5)	14.5 to 72.5 (1.0 to 5.0)	180° up/down	1.5 (37)	194 (90)	Rinsing open top totes or small vessels

TANKJET® TANK AND CHEST CLEANERS

CHEST CLEANERS

QUICK REFERENCE GUIDE

Nozzle	Max. Tank Dia. ft. (m)	Operating Principle	Flow Rate gpm (lpm)	Operating Pressure psi (bar)	Spray Coverage	Min. Tank Opening in. (mm)	Max. Temp. °F (°C)	Typical Applications
TankJet 21400A 	5 (1.5)	Fluid-driven reactionary force	5.0 to 22 (23 to 82)	10.0 to 60 (0.7 to 4.1)	360°	2.25 (60)	350 (177)	Rinsing totes or small vessels
TankJet VSM 		Fixed stationary	2.7 to 72 (10.4 to 269)	10.0 to 150 (0.7 to 10.3)	240° down	2 (51)	200 (93)	Rinsing or foam control in small tanks
TankJet 30473 	3 (0.9)	Fluid-driven reactionary force	2.1 to 4.5 (7.8 to 18.0)	10.0 to 50 (0.7 to 3.4)	180° up/down, 360°	1 (25)	200 (93)	Cleaning or foam control in small tanks with small openings
TankJet 23240-2 23240-3 		Fluid-driven reactionary force	3.5 to 22 (14.0 to 79)	20 to 200 (1.4 to 13.8)	360°, side spray	1.03 (26)	350 (177)	Cleaning small headboxes, ducts or vessels

MESH RECOMMENDATIONS

Nozzle Type	Mesh Recommendation
Motor Driven Tank Cleaner	100 min.
Fluid Driven (Turbine)	30 to 50
Fluid Driven (Reactionary Force and Constant Speed)	200 min.
Fixed Stationary	Refer to Mesh to Micron Conversion Chart

MESH TO MICRON CONVERSION CHART

Mesh	Micron	Inches (mm)
16	1191	0.0469 (1.2)
20	840	0.0331 (.84)
30	590	0.0232 (.58)
50	297	0.0117 (.29)
60	250	0.0098 (.24)
80	177	0.0070 (.17)
100	149	0.0059 (.14)
200	74	0.0035 (.08)

FOR DETAILED NOZZLE PERFORMANCE DATA, SEE TANKJET® TANK CLEANING PRODUCTS, CAT. 75TJ



OVERVIEW: STRAINERS

- Reduce clogging in tank cleaners and tank cleaning nozzles
- Remove contaminants from liquid to ensure continuous movement of rotating spray heads
- Extend wear life of nozzles, valves and pumps
- Wide range of options: heavy duty, heavy duty high pressure, self cleaning and a wide range of mesh sizes

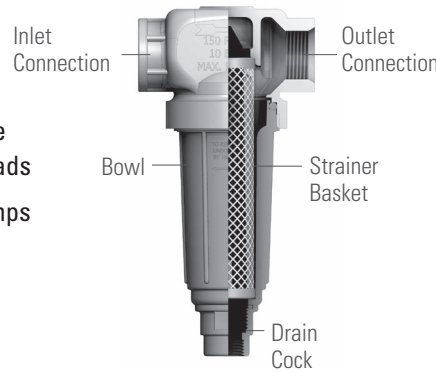

T-Style Strainer

T-strainers feature a removable bottom cap or plug for complete withdrawal of the screen assembly during cleaning. On some models, the bottom pipe plug can be replaced with a drain cock for quick-flush cleaning. Models with a clear nylon bowl allow easy visual inspection of the internal screen. Self-clean designs allow filtered liquid to pass through, while liquid particles are returned back to the liquid supply through a return outlet.

STRAINER OPTIONS

TWD

- 1/4", 3/8", 1/2", 3/4", 1", 1-1/4", 1-1/2", 2", 2-1/2" female conn.
- Removable bottom plug for easy screen cleaning
- Bottom plug can be replaced with drain cock for flush cleaning
- Use TWC for connections of 3" and up.
- TWC handles large flow rates with minimal pressure drops. Call your local specialist for application assistance.
- Materials: Aluminum, brass, stainless steel
- Mesh: 16, 30, 50, 80, 100, 40 x 200 Dutch weave
- Max. pressure: 300 psi (20 bar)



8310A

- 1/4", 3/8", 1/2" female connection
- Designed for high pressure operation
- Removable bottom plug for easy flush cleaning of screen
- Material: Stainless steel
- Mesh: 16, 30, 50, 100
- Max. pressure: 5000 psi at 150°F (345 bar at 66°C)



AA124/AA430

- 3/4", 1", 1-1/4", 1-1/2", 2", 2-1/2" female connection (Inlet connections vary depending on strainer type)
- Larger size screen area requires less frequent cleaning
- Self-cleaning styles and versions with mounting lugs available
- AA124 and AA430 versions are the same except for materials and inlet connections



Strainer Type	Strainer Part No.	Material*	Max. Pressure	Mesh Sizes
124	AA124-AL	Aluminum head/nylon bowl	150 psi (10 bar)	16, 30, 50, 80, 100
124ML with mounting holes**	AA124ML-AL	Aluminum head/nylon bowl	150 psi (10 bar)	16, 30, 50, 80, 100
124A self-cleaning version	AA124ASC-NYB	Aluminum head/nylon bowl	110 psi (8 bar)	16, 30, 50, 80, 100
430ML with mounting holes**	AA430ML	Polypropylene head/nylon bowl	110 psi (8 bar)	16, 30, 50, 80, 100, 120, 200 [†]
430 self-cleaning version	AA430SC	Polypropylene head/nylon bowl	75 psi (5 bar)	16, 30, 50, 80, 100, 120, 200 [†]

*Max. temperature for plastic 100°F (38°C); max. temperature for metal 180°F (82°C).
 **For mounting on machinery or angle iron.
[†]120 only for 1-1/4" and 1-1/2" sizes; 200 only for 3/4" and 1" sizes.





QUICK REFERENCE GUIDE

Model	Connection Type	Connection Size in.	Material
TWD	Female	1/4, 3/8, 1/2, 3/4, 1, 1-1/4, 1-1/2, 2, 2-1/2	Aluminum, brass, stainless steel
8310A	Female	1/4, 3/8, 1/2	Stainless steel
AA124/AA430	Female	3/4, 1, 1-1/4, 1-1/2, 2, 2-1/2	Aluminum head/nylon bowl or Polypropylene head/nylon bowl



AIR KNIFE PACKAGES AND AIR NOZZLES

TABLE OF CONTENTS

	PAGE
BLOWER AIR PRODUCTS	
 WindJet® Air Knife and Regenerative Blower Packages	13
 WindJet Air Cannons	13
 Accessories	14
WINDJET COMPRESSED AIR NOZZLES	
 WindJet Nozzles	15
 WindJet Low Flow Air Knives	15
 WindJet Variable Air Amplifiers	15
 UniJet® Nozzles	16



OVERVIEW: WINDJET AIR KNIFE PACKAGES AND COMPRESSED AIR PRODUCTS

Ideal for: sheet control, dust blow-down, CIP air control system, drying and sheet cooling

WindJet Air Knife Packages

- Powered by regenerative blowers and eliminate the need for costly compressed air
- Regenerative blower performance advantages over other blower types:
 - Lower noise
 - Lower maintenance
 - Longer life
 - Lower operating costs
 - Warm air can improve drying
 - Fully customized solution
- Packages include air knives that produce a uniform, high volume, constant air stream along the entire knife length
- Air cannons providing high velocity air directed into holes and crevices for complete drying or blow-off are also available
- Air knife packages are commonly used when extremely clean air is required (HEPA filtration an option), no existing air source is available or energy reduction is desirable

WindJet Compressed Air Nozzles

- Convert low-pressure volumes of air into a targeted, high-velocity stream or flat fan air pattern and provide many benefits, including:
 - Improve drying or blow-off by increasing impact on the target
 - Use 25% to 35% less air compared to open holes or slits in pipes
 - Reduce perceived noise by 28% to 60% compared open pipe



FOR DETAILED PERFORMANCE DATA, SEE
WINDJET® AIR PRODUCTS, CAT. 20

BLOWER AIR PRODUCT OPTIONS

WindJet® Air Knives

- Superior performance – straight, controlled air stream
- Standard knife lengths of 6", 12", 18", 24", 30" and 36" (152, 305, 457, 610, 762 and 914 mm)
- Custom lengths available
- Dual inlet knives available (suggested for lengths greater than 60" [1524 mm])
- Air slot sizes of .040" and .060" (1 and 1.5 mm)
- Leak-proof end cap gaskets to prevent leakage on aluminum air knives
- Corrosion-resistant finish
- 3" (76.2 mm) flanged air inlet



Regenerative Blower Assemblies

- 5.5, 10, 20, 25 and 30 Hp. (4.0, 7.5, 15, 18.5, 22.3 kW)
- Assemblies include pressure relief valve, pressure gauge, air inlet filter, filter monitoring gauge, fittings, mounting adapter for flexible or rigid tubing
- Low maintenance, direct drive operation
- Fan cooling dissipates heat around the bearings to extend wear life
- Continuous, non-pulsating, oil-free air flow
- Low noise
- Rugged cast aluminum construction
- Lightweight
- Tropicalized for corrosion protection
- No heating element; air is warmed by heat generated during operation
- TEFC motors; CE and cURus certified
- Mountable in any position (except F30 which requires vertical mounting)
- Three-phase, dual frequency and multi-voltage motor versions
- Filter monitoring gauge alerts operator when service is required
- Wash down units available



WindJet® Air Cannons

- Complete drying by providing a high velocity air stream into holes and indentations in irregularly shaped parts
- Built-in mount spacer simplifies positioning in a mount bracket
- Corrosion-resistant finishes
- Three orifice sizes: .5", .75" and 1" (12.7, 19 and 25.4 mm)

For complete specifications, performance data and accessories, see WindJet® Air Products, Cat. 20F.



BLOWER AIR PRODUCT ACCESSORIES

Mounting Brackets

- These 100% stainless steel adjustable brackets are used for conveniently mounting air knives. Two specialized mounting plates connect to each end cap on the air knife

Note: Request data sheets 50040 and 55158 for dimensions



Flexible Tubing

- High-temperature, steel-reinforced flexible tubing available in 3" and 6" (76.2 and 152.4 mm) diameters and comes in lengths of 10' (3 m). High-torque, worm-gear clamps are available to attach the flexible tubing



Couplings

- Unique, easy to use 3" and 6" (76.2 and 152.4 mm) couplings – stainless steel outside, high temperature silicon rubber inside. The couplings compress for use between any rigid connections to prevent air leakage and to add support for the connections. A single built-in clamp is tightened by hand; no special tools are necessary



Noise Reduction Options

- Sound Enclosure (shown): Insulating hoods reduce noise by 10 dBa. Metal construction for easy washdown. (Not available for Model F30)

Note: Request data sheet 50218



Manifolds

Constructed from high-strength, high-temperature thermoplastic, manifolds allow a single air outlet on the blower to be divided for multiple knives in various ways. Other materials available.

- **Y-divider:** Allows for single inlet to be divided into two outlets. Available in both 3" and 6" (76.2 and 152.4 mm) inlet OD, with 3" (76.2 mm) outlet OD
- **3-port:** Allows for single inlet to be divided into three outlets. Available in both 3" and 6" (76.2 and 152.4 mm) inlet OD, with 3" (76.2 mm) outlet OD. Designed with mounting holes for support
- **4-port (shown):** Allows for single inlet to be divided into four outlets. Available in both 3" and 6" (76.2 and 152.4 mm) inlet OD, with 3" (76.2 mm) outlet OD. Designed with mounting holes for support

Note: Request data sheets 50773 and 50774 for additional dimensions of manifolds.



FOR DETAILED PERFORMANCE DATA, SEE
WINDJET® AIR PRODUCTS, CAT. 20

All necessary accessories for mounting and implementing the product into your applications are included in the air knife package. Accessories vary by package.

WINDJET® AIR NOZZLES, LOW FLOW AIR KNIVES AND AMPLIFIER OPTIONS

AA727 WindJet Nozzles

- Generate efficient, controlled flat fan air pattern for a uniform spray distribution
- Designed to maintain spray pattern integrity
- Available in materials that withstand high temperatures
- Recessed orifices protect against external damage and offer air escape should the nozzles accidentally be placed against a flat surface
- Low noise levels
- Can be mounted side-by-side for air curtain applications
- Compact version available; Y767 is less than half the height of the AA727

AA707 WindJet Nozzles

- Produce tightly directed round spray pattern
- Low noise levels
- Color-coded aluminum caps for easy identification of flow rates
- Recessed orifices
- Common uses: debris removal from optical scanners, stock blow-off from rolls, cleaning production areas, sheet control for paper breaks, tissue sheet control, CIP air control system on dry end of tissue machine, air knock-off shower in broke pit and boundary layer air barriers



WindJet Low Flow Air Knives

- 3" (8 cm) air knife uses 92% less air than same size pipe with three drilled holes
- Ideal for applications using 1 or 2 air knives
- Deliver a high velocity, constant air stream for fast drying and blow-off
- Reduce energy use
- Lower noise levels, 69 dBa for most applications
- Compact and designed for small areas
- Common uses: sheet control for paper breaks, sheet edge blow-off/knock-off where water is not a viable option, converting plants, bag plants and box plants



WindJet Variable Air Amplifiers

- Produce high volume air stream using free air for targeted drying or blow-off
- Allows for adjustability in performance
- Common uses: dust blow-off, broke blow-off in calendar dryer stacks and ventilation



UNIJET® AIR NOZZLE OPTIONS

UniJet Nozzles

- Deliver a wide, uniform flat spray pattern
- Common uses:
 - Blow-off stock from rolls
 - Sheet control for paper breaks
 - Air knock-off shower in broke pit
 - Boundary layer air barriers for coating applications



QUICK REFERENCE GUIDE

Tip Type	Connection/Type	Connection Size in.	Capacity scfm (Nlpm) at 25 psi (2 bar)
L	M or F	1/8, 1/4, 3/8	1.3 (41)
P			2.0 (63)
Q			3.9 (123)
R			6.4 (207)
U			11.0 (354)
V			23 (724)

QUICK REFERENCE GUIDE





Model	Usage Tips/Typical Applications	Connection/Type	Conn. Size in.	Max. Operating Temperature psi (bar)	Materials
AA727 WindJet® Air Nozzle	Narrow flat patterns to create air curtains with multiple tips side-by-side for knockdown or protecting areas	M or F	1/4	At 100 (7)	
				170°F (77°C)	ABS plastic
		M	1/4	At 150 (10.3)	
				500°F (260°C)	Stainless steel
		M	1/4	At 100 (7)	
				180°F (82°C)	Polyphenylene sulfide
450°F (230°C)	Aluminum				
AA707 WindJet Air Nozzle	Round pattern with farther throw distance for keeping sensors clean or spot protection	M	1/4	At 125 (8.6)	
				400°F (204°C)	Polyphenylene sulfide
				220°F (104°C)	PVDF
				450°F (230°C)	Aluminum, stainless steel
180°F (82°C)	ABS plastic				
Y767 WindJet Air Nozzle	Compact version of AA727, can also used to create air curtains with multiple tips side-by-side	M	1/4	At 100 (7)	
				180°F (82°C)	ABS plastic
WindJet Low Flow Air Knives Lengths: 3, 6, 12, 18 and 24 in. (8, 15, 30, 46, and 61 cm)	Provide low consumption air curtains for compact areas	F	1/4	At 200 (13.8)	
				140°F (60°C)	Aluminum with plastic shim
200°F (93°C)	316 stainless steel body and shim				
Air Amplifiers	High volume air stream in focused area for blow-off or sensor protection	F	1/8, 1/4, 3/8, 1/2	–	Aluminum, 316 stainless steel
UniJet Nozzles	Wider flat fan patterns for spacing across spray booms with lower impact force	M	1/8, 1/4, 3/8	–	Brass, Stainless steel

FOR DETAILED PERFORMANCE DATA, SEE WINDJET® AIR PRODUCTS, CAT. 20



SPRAY GUNS

TABLE OF CONTENTS

	PAGE
 GunJet® Spray Guns	J2
 GunJet Low Pressure Spray Guns	J3
 GunJet Medium Pressure Spray Guns	J4
 GunJet High Pressure Spray Guns	J4



OVERVIEW: GUNJET SPRAY GUNS

Ideal for: plant clean-up

- Full range of handheld spray guns ranging from gentle low-pressure to high-impact, high-pressure sprays
- Specially designed handles to improve control and reduce operator fatigue
- Smooth-pull triggers to enable accurate and consistent flow control
- Textured grips to minimize the chance for slippage and accidents
- Wide range of nozzles, extensions, adapters, connectors and strainers available

Some of the most commonly used products in mills are featured here. For complete specifications and performance data, see GunJet Spray Guns, Cat. 75A.



GUNJET SPRAY GUN OPTIONS

CU150A Low Pressure Spray Gun

- Black or white rubber outer cover
- Color bands for easy identification of flow capacities
- Adjustable spray pattern from hollow cone to solid stream
- Optional swivel connectors with trigger lock provide smooth 360° operation, eliminating hose kinking and reducing operator fatigue
- Choice of brass, aluminum or stainless steel body
- Spare parts kit available for easy maintenance, see GunJet Spray Guns, Cat. 75A



FOR MORE OPTIONS, SEE
GUNJET SPRAY GUNS, CAT. 75

GUNJET® SPRAY GUNS





SPRAY GUNS

AA70 High Pressure Spray Guns

- Trigger lock and guard
- Designed to withstand high impact
- Ergonomic design with light trigger pull
- Large grip area to accommodate work gloves
- Vented handle remains comfortable during hot spraying operations
- Optional “weep” feature helps prevent freezing in cold conditions
- In-line swivel provides smooth 360° operation, eliminating hose kinking and reducing operator fatigue
- IMEG, MEG, QCIMEG WashJet® spray tips available.
See Hydraulic Spray Products, Cat. 75 for performance data





LOW PRESSURE GUNJET SPRAY GUNS QUICK REFERENCE GUIDE

Model	Model Type	Max. Operating Pressure psi (bar)	Capacity gpm (lpm)	Max. Temperature °F (°C)	Inlet Conn. Type/Size in.	Outlet Conn. in.
	AA30L	250 (17)	5 (19)	200 (93)	1/4 F	11/16-16 UniJet® THD
	AA60-21580	250 (17)	16 (60)	300 (150)	3/8 F	—
	CU150A	150 (10)	10 to 22 (38 to 83)	200 (93)	1/2 F	—
	AA36	150 (10)	7 (27)	140 (60)	1/4, 3/8 F	1/4, 3/8 F

SPRAY GUNS

GUNJET® SPRAY GUNS

MEDIUM PRESSURE GUNJET SPRAY GUNS QUICK REFERENCE GUIDE

Model	Model Type	Max. Operating Pressure psi (bar)	Capacity gpm (lpm)	Max. Temperature °F (°C)	Inlet Conn. Size/Type in.	Outlet Conn. Size/Type in.
	36533-60	600 (41)	12 (45)	200 (93)	3/8 F	11/16-16 UniJet® THD
	AA23L	250 (17)	5 (19)	200 (93)	1/4 NPS M	11/16-16 UniJet THD
	AA31	500 (35)	5 (19)	200 (93)	1/4 NPS M or NPT or BSPT F	11/16-16 UniJet THD

HIGH PRESSURE GUNJET SPRAY GUNS QUICK REFERENCE GUIDE

Model	Model Type	Max. Operating Pressure psi (bar)	Capacity gpm (lpm)	Max. Temperature °F (°C)	Inlet Conn. Size/Type in.	Outlet Conn. Size/Type in.
	AA30A	1500 (105)	5 (19)	200 (93)	1/4 F	11/16-16 UniJet® THD
	AA60	2500 (175)	6 (23)	300 (150)	3/8 F	11/16-16 UniJet THD
	AA70	5000 (345)	10 (38)	300 (150)	3/8 F	1/4 F
	AA80	3000 (207)	10 (38)	300 (150)	3/8 F	11/16-16 UniJet THD or 1/4, 3/8 F

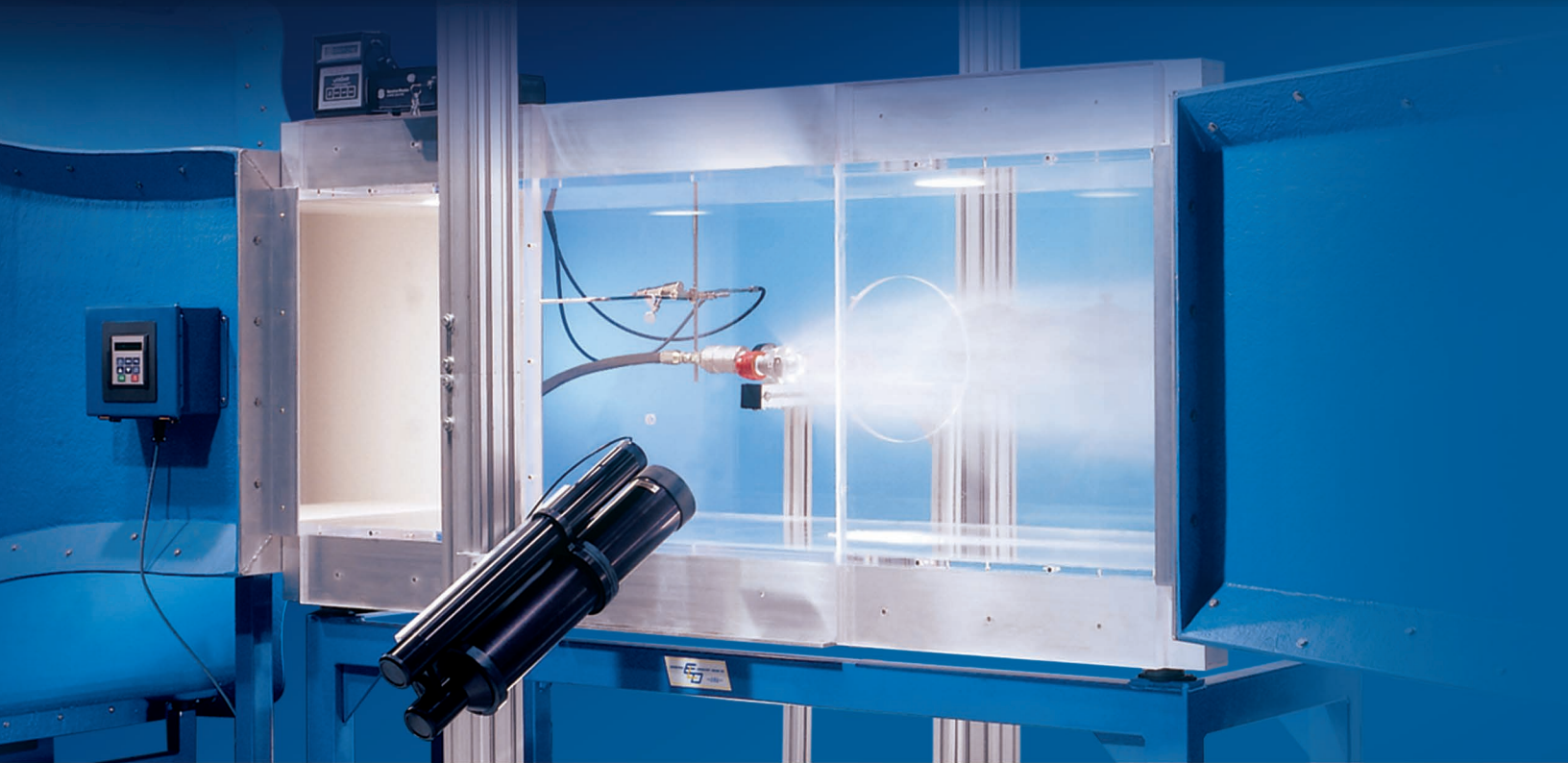

OPTIMIZATION & SUSTAINABILITY

TABLE OF CONTENTS

	PAGE
 Ways to improve performance	K2
 Practice preventive maintenance	K7
 Take advantage of our expertise	K9



WAYS TO IMPROVE PERFORMANCE

MAKE SURE YOU'RE USING THE BEST PRODUCTS FOR THE OPERATION

Advancements in spray technology can help improve process efficiency and product quality while controlling costs. If you haven't recently evaluated the operations that use spray technology in your mill, you may discover new ways to improve pulping, washing, trimming, coating, converting and other operations. Start by reviewing the information below and then contact your local spray expert for more information.

AUTOMATIC BRUSH SHOWERS

Improve worker safety while implementing an affordable, automated solution. Automatic Brush Showers allow you to eliminate manual brush operation in existing applications and manual cleaning entirely in new applications. If you have manual brush-type showers, our control unit replaces manual handwheel operation, allowing brush activation via a single push of a button. Aside from gear lubrication twice a year, the Automatic Brush Shower requires no other maintenance time. In addition, the cleaning cycle occurs without interrupting operation, maximizing machine uptime.

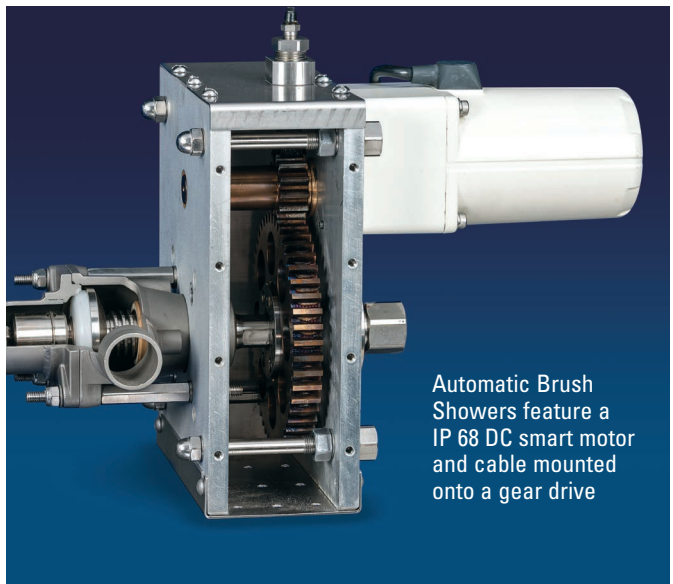

Automatic Brush Showers feature a IP 68 DC smart motor and cable mounted onto a gear drive

AUTOMATIC SPRAY CONTROL

If your operations require precise, uniform application of costly coatings or moisture, an automated spray system may provide a quick return on investment by reducing waste and scrap. A wide range of dedicated spray controllers is available offering everything from simple on/off control to total automation. Typical benefits of spray control include:

- Quality is improved – under and over-application problems are eliminated, reducing scrap. Some spray controls can adjust the application rate based on changes in operating conditions such as line speed
- Overspray is minimized – chemical and coating waste are eliminated lowering operating costs and improving worker safety

Automated spray systems are being used in mills around the world in operations like these:

- Automatic activation of individual nozzles or a zone of nozzles based on paper width to eliminate scrap during changeover or downtime to change spray set-ups
- Precise control of moisture. The spray controller automatically adjusts the flow rate based on input from a moisture sensor to ensure proper wetting
- Defect detection. The spray controller triggers nozzles to spray based on input received from a vision system

PRECISION SPRAY CONTROL (PSC)

PSC helps reduce chemical use while ensuring uniform application of coatings. PSC is achieved by turning electrically-actuated spray nozzles on and off very quickly to control flow rate.

Benefits include:

- Reduces scrap caused by over- or under-application of coatings
- Reduces the use of costly coatings by applying the proper coating volume directly on the target
- Increases production – fast cycling (up to 25,000 cycles per minute) of nozzles keeps pace with high line speeds

AUTOMATED TANK/CHEST CLEANING PRODUCTS

If chests and tanks in your mill are being cleaned manually or via fill and drain methods, consider improving worker safety and reducing costs with automated tank cleaning equipment. Automated tank cleaning efficiently, effectively and safely cleans stock chests, black liquor storage chests, pulp towers and more. Some mills have reported saving up to USD\$50,000 per year per stock chest by changing to automated tank cleaning equipment.

NOZZLES

New nozzle designs offer greater precision, better efficiency and longer wear life. Some examples are:

- Clog-resistant designs minimize performance problems and unscheduled downtime
- Quick-connect styles reduce maintenance time in yankee chemical showers or critical alignment applications
- One-piece, high-pressure ShowerJet nozzles simplify installation and removal by integrating the nut and gasket into the nozzle design

Making a small investment in time to review your showers and chest cleaning operations can result in big savings. You may discover new ways to improve efficiency and lower operating costs.



PERFORM REGULAR NOZZLE INSPECTIONS

Spray nozzles are at the heart of all the applications that use consumables throughout the mill. These seemingly simple components have a significant impact on performance and operating costs in moisturizing, cleaning, lubricating, edge trimming, bleaching, knock-off, gluing and dozens of other applications.

Like all precision components, spray nozzles will wear over time with use and should be monitored and maintained according to a schedule. It's important to determine the wear rate for your application. For example, shower nozzles that are used for trimming, separating the formed edge and creating a cleaner edge have a very high wear rate. When

nozzles are worn, the patterns break up and can cause an irregular cut. A good maintenance program to replace the nozzles regularly will help prevent issues due to worn nozzles.

Even slight wear can cost tens of thousands of dollars annually in increased operating expenses. As spray nozzles wear, their orifices become larger and, at any given pressure, the flow rate increases. Worn nozzles that spray over capacity are wasting more than water. Electricity costs will rise due to excess pump operation and chemical costs will also increase.

HERE ARE TWO EXAMPLES THAT ILLUSTRATE THE EXPENSE AND WASTE ASSOCIATED WITH USING WORN NOZZLES.

EXAMPLE #1: DRYER SECTION SHOWER – One shower with 70 nozzles spraying a release agent on dryer felt

OPERATING CONDITIONS:

- System sprays 5 gpm (19 lpm) of a 1:20 aqueous solution of chemical at 40 psi (2.76 bar)
- Chemical consumption: .25 gpm (.95 lpm); \$0.50 per gallon
- Operation: Three shifts, five days per week = 120 hours per week

15% NOZZLE WEAR = 15% INCREASE IN WATER, CHEMICAL & ELECTRICITY COSTS

Water expense:	\$6,135
Chemical expense:	\$53,820
Electricity expense:	\$3,118
Total operating costs at 15% wear:	\$63,073

Note: Does not include water filtration and recovery costs. All costs are in USD.

The cost to operate this one shower increases from \$54,803 to \$63,073. **If you have six showers in the dry end, your costs increase by \$49,620 annually.**

Use our online Nozzle Wear Calculator to help expedite your calculation: www.spray.com

EXAMPLE #2: FABRIC CLEANING SHOWER – One shower with 72 high-pressure nozzles

OPERATING CONDITIONS:

- Nozzle size: 2.34 gpm (8.8 lpm) at 350 psi (24.1 bar)
- Operation: 60 hours per week, 48 weeks per year

15% NOZZLE WEAR = WASTE OF MORE THAN 4,000,000 GALLONS OF WATER ANNUALLY FOR ONE SHOWER

Increased capacity for the shower: 168.5 to 193.8 gpm (637.8 to 733.4 lpm)

Increased annual water consumption: 4,367,002 gallons (16,531 kiloliters)

There are 660,430 gallons of water in an Olympic-sized pool.

The water wasted each year from this one shower alone is enough to fill nearly seven Olympic-sized pools. Meet your commitment to reduce water consumption waste by replacing nozzles regularly.



Protecting the Environment Through Process Optimization

LOWER UTILITY BILLS BY IMPROVING BLOW-OFF AND DRYING EFFICIENCY

Many mills use pipes with drilled holes or slits for drying or blow-off. This approach consumes high volumes of costly compressed air. Use of compressed air nozzles or air knife packages powered by regenerative blowers are good alternatives and can dramatically reduce energy consumption.

COMPRESSED AIR NOZZLES

Compressed air nozzles convert low-pressure volumes of air into a targeted, high-velocity stream or flat fan air patterns and provide many benefits:

- Significant improvements in drying or blow-off by increasing impact on the target
- A significant decrease in air consumption compared to open holes or slits in pipes
- Reduced noise level

AIR KNIFE PACKAGES WITH BLOWER AIR

Using regenerative blowers and air knives eliminates the need for compressed air. Regenerative blower benefits include:

- Low noise operation
- Low maintenance
- Dependable operation and long wear life
- Low operating costs
- Improved drying due to warm air use

Air knives produce a uniform, high-volume, constant air stream along the entire knife length. The result is uniform, complete drying without blotches or spotting or highly efficient blow-off.

WindJet® Air Knife packages are customizable based on application requirements.



SIGNIFICANT SAVINGS OPPORTUNITY:

A single operation in a mill using a 4' (1.2 m) pipe with slits can cost	\$350,000+ annually
--	---------------------

Different approaches to drying and blow-off can cost just	\$30,500 annually
---	-------------------

A possible savings of more than	\$300,000 per year
--	---------------------------

Note: All costs are in USD.

The cost of a new drying or blow-off system is quickly offset by the tremendous savings in operating expenses.

Your local spray expert can help you compare the options and costs of using compressed air nozzles versus air knife packages with blower air.

ASK FOR EXPERT HELP

Our local spray experts are available to help evaluate your operations and identify ways to improve performance.

Nozzle wear

In most cases, nozzle wear is difficult to detect because it isn't visible. The gradual erosion of nozzle orifices can't be seen when inspecting the nozzle or observing the spray. Measuring nozzle flow rate is generally required so actual flow rate can be compared to the rated flow rate. In other cases, the most effective way to determine wear rate and determine the optimal replacement interval is to evaluate the worn nozzles in our spray laboratories using specialized test equipment.

Complimentary visual inspections

- Occur while machine is running
- Include visual inspection of all showers and nozzles on the machine for obvious spray problems
- Include documentation of nozzle and shower locations
- Include a written report of inspection results along with recommendations for operational enhancements if appropriate

Complimentary nozzle audits

- Occur during shut-down
- Include an inspection of all nozzles on the machine; size and condition of nozzles are noted
- Include identification of nozzles that need replacement
- Can be completed in one to four hours depending on machine
- Include a written report with optimization tips, documentation on every nozzle and shower by location and maintenance recommendations

Contact your local spray expert today for on-site assistance.

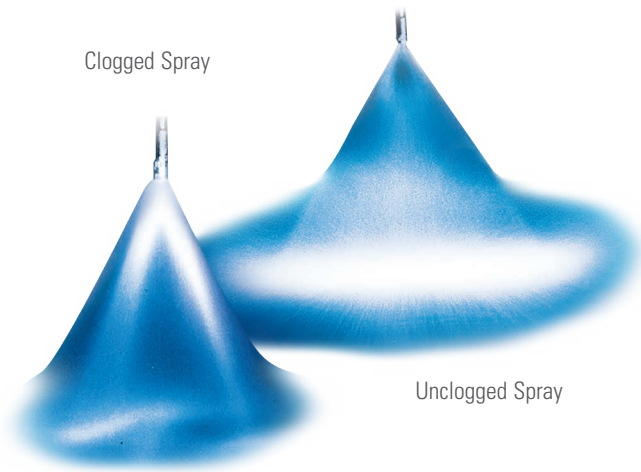

PRACTICE PREVENTIVE MAINTENANCE

MAINTENANCE TIPS

Implement these tips into your maintenance programs to extend product life and minimize downtime.

PLUGGING

- Use proper water clarification devices
- Use strainers
- Be sure to specify nozzles with adequate free passage
- Conduct maintenance on a regular basis
- Use automated self-cleaning showers

CORROSION

- Specify nozzles in the appropriate materials: 316 or 303 stainless steel bodies and synthetic ruby or ceramic orifices depending on chemical concentration. Avoid iron and mild steel

SCALE BUILD-UP

- Control hardness level of the water
- Use chemical additives as needed
- Conduct maintenance on a regular basis

SLIME AND ODOR

- Implement an effective biocide program to control biological growth
- Use chemical additives as needed
- Eliminate areas with stagnant water
- Conduct frequent wash-ups

CAKING

- Conduct maintenance on a regular basis



NOZZLE MAINTENANCE GUIDELINES

- Examine spray patterns and watch for changes in spray angles, distribution and heavy edges
- Wear may be hard to detect so go beyond visually inspecting nozzles. Check flow rate and spray pressure at a system level
- The nozzle orifice is precision engineered so be careful to avoid damage or replacement will be necessary
- Cleaning tools should be significantly softer than the construction material of the nozzles, such as a toothbrush, toothpick or brushes in the showers. Never clean the orifice with metal objects
- Soak nozzles in mild solvent to loosen debris for easier removal with proper equipment

NOZZLE WEAR IS DIFFICULT TO DETECT BUT WORTH THE EFFORT TO PREVENT WASTE

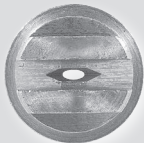

GOOD SPRAY TIP

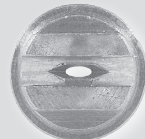

WORN SPRAY TIP

Nozzle tips show little visible difference. The tip on the left is new. The same size tip shown to the right has worn to the point at which it sprays 30% over capacity. Visual inspection shows little evidence of wear.

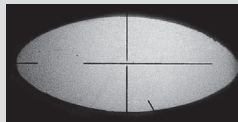

GOOD SPRAY TIP

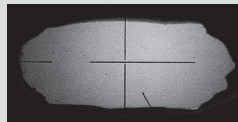

WORN SPRAY TIP

Orifice viewed through an optical comparator shows evidence of internal wear. A closer inspection and an analysis of spray collection data shown in the image on the right reveal the difference between the two tips.

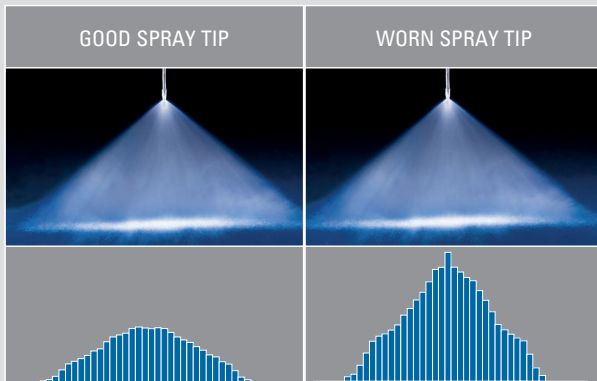

Spray patterns of both tips show little difference. Spray collection in tubes gives dramatic evidence of 30% increase in capacity.

NOZZLE MATERIAL

Nozzles made from harder materials generally provide longer wear life. In addition to standard materials such as brass and stainless steel, more durable spray nozzles are often available in specialty materials, carbides or with ruby orifices. Nozzles with a synthetic ruby orifice are frequently used for web trimming because they provide up to 2000 times greater wear resistance than brass. In addition, the stream remains steady even in the early stages of wear. Many solid stream shower nozzles also are available with ruby orifices to help extend wear life and ensure proper cleaning of fabrics for longer periods of time.

To help determine if you should consider a change, the standard abrasion resistance ratios for many of these materials are listed below.

APPROXIMATE ABRASION RESISTANCE RATIOS

Spray Nozzle Material	Resistance Ratio
Aluminum	1
Brass	1
Polypropylene	1-2
Steel	1.5-2
Stainless Steel	4-6
Hardened Stainless Steel	10-15
Silicon Carbide (Nitride Bonded)	90-130
Ceramics	90-200
Carbides	180-250
Synthetic Ruby or Sapphire	600-2000

SELF-CLEANING NOZZLES OR STRAINERS

In many applications, orifice deterioration and clogging are caused by dirt particles in the sprayed liquid. This is particularly common in systems using continuous spray water recirculation. In an average production process, recycling of water enables approximately 17 uses before discharge, as opposed to one or two uses without recirculation.

Self-cleaning nozzles feature a piston-type design. When line pressure is low, the piston retracts to purge debris from the nozzle orifice. Self-cleaning nozzles are ideal for use inside showers and machines because of their compact design.

Strainers, or nozzles with built-in strainers, trap larger particles and prevent debris from entering the nozzle orifice or vane to significantly reduce wear.

TAKE ADVANTAGE OF OUR EXPERTISE



EXPERT ADVICE IS RIGHT WHERE YOU NEED IT – IN YOUR MILL BY LOCAL EXPERTS

Our specialty is finding ways to improve efficiency in operations and help you achieve greater profitability and sustainability. For example, one tissue manufacturer was able to develop a coreless tissue line that allows more sheets of tissue to be wound on each roll using an AutoJet® spray system. Eliminating the cardboard tubes and plastic end caps has generated an annual savings of over USD\$40,000 and removed the tubes and end caps from the waste stream.

COMPLIMENTARY LUNCH AND LEARN WORKSHOPS

Select a topic, choose a date and invite your colleagues. We'll provide lunch and an informative 60-minute session. Popular topics include How to Reduce Water and Energy Use, How to Optimize Transfer Efficiency, Maintenance Workshops and more.

TESTS AND DEMONSTRATIONS AVAILABLE AT REGIONAL SPRAY TECHNOLOGY CENTERS

Throughout North America, we have several Spray Technology Centers. These facilities are equipped to conduct proof-of-concept tests and technology demonstrations. Seminars including live demonstrations on various topics are also conducted throughout the year. Schedules vary by region so contact your local spray expert for information.



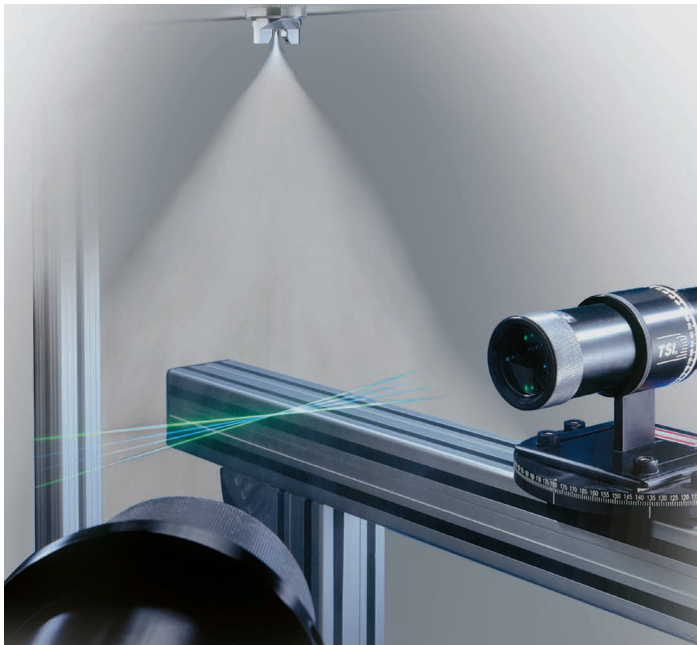

RESEARCH SERVICES THAT OPTIMIZE CHALLENGING OPERATIONS

Many spray operations require high precision and there is little or no margin for error. For example, if you're spraying glues, starches, adhesives or other coatings, selecting correct nozzles and determining optimal nozzle spacing, height and position can be challenging. In addition, nozzle clogging and frequent process interruptions are unacceptable so it is important to select the best nozzle for spraying viscous liquids. In our state-of-the-art spray laboratories, we can simulate your operating conditions using your chemicals/liquids to determine how to achieve the exact performance you need. Conducting spray performance testing prior to nozzle and shower selection in new applications or in critical operations helps ensure optimal performance.

BUILT-TO-ORDER SHOWERS AND HEADERS

When a standard shower doesn't provide the required performance or fit into your current environment, we can design and fabricate one that will. Built-to-order showers are available in a wide range of styles – brushless, brush-type, air atomizing, oscillating and more. Shower length, number and placement of nozzles, connections and more can be customized.

Let us show you why mills around the globe rely on us to help boost production, improve paper and tissue quality, lower operating costs, minimize waste and more.

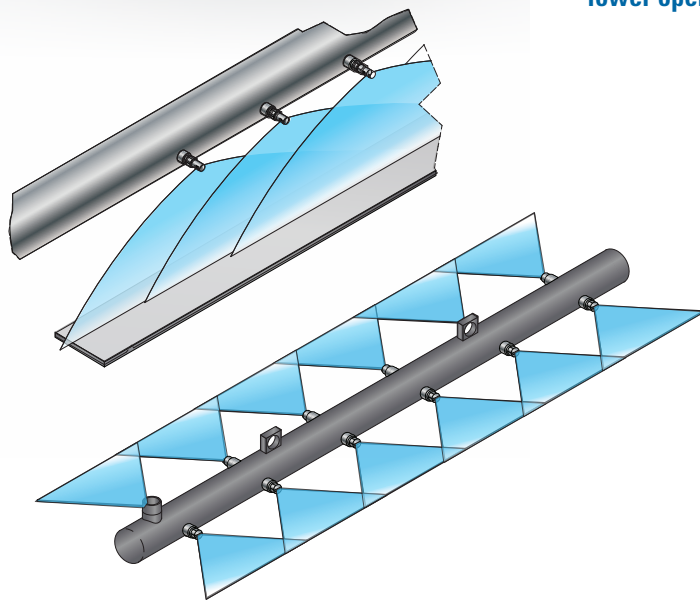

INDEX



AIR KNIFE PACKAGES & AIR NOZZLES

AA707 WindJet® I5
 AA727 WindJet..... I5
 Air Amplifiers I5
 Air Cannons I4
 Air Knives I3, I5
 Regenerative Blower Assemblies I3
 UniJet® I6
 Y767 WindJet I6
 Accessories I7

AUTOMATIC & AIR ATOMIZING NOZZLES

Air Atomizing

1/4J G8
 1/8J G8
 1/8JJ G9

Air-Actuated Air Atomizing

1/4JAU G6
 1/8JJAU G6
 10535-1/4J G7
 VAU G7
 VMAU G7

Electrically-Actuated Air Atomizing PulsaJet®

AA10000JJAU G5
 AA10000JAU-10 G5

Electrically-Actuated Hydraulic PulsaJet

AA10000AUH-03 G4
 AA10000AUH-10 G4

Fogging & Humidification

1/4JH G11, G12
 1/4JT G11, G12
 45400 G12
 45265 G10
 45269 G10
 55089 G12
 YMF MiniFogger® III G11

FLAT SPRAY NOZZLES

Black Liquor

45824 Splash Plate E7
 VeeJet® U E7

FlatJet® Narrow Angle Spray

115220 E11
 P E11

FloodJet® Wide Angle Spray

11499 E10
 13063 E10
 K E10

Quick-Change QuickJet® Standard Spray

58106 E5
 QJA E5
 QJJA E5
 QUA E5
 QVVA E5

UniJet® Standard Spray

13802 E6
 49803 E6
 58102 E6
 T E6
 TPU E6
 TT E6, E9

Quick-Change QuickJet Wide Angle Spray

QJA E8
 QJJA E8
 QJJS E8
 QSTK E8
 QTKA E8

Quick-Change UniJet Wide Angle Spray

T E9
 TK E9
 TT E6, E9

Quick-Change QuickJet Narrow Angle Spray

QLPA E12

QJLA E12
 QJJLA E12

VeeJet®

H-DT E4
 H-DU E4
 H-VV E4
 H-VVL E4
 U E4

GUNJET® SPRAY GUNS

36533-60 J4
 AA23L J4
 AA30A J5
 AA30L J3
 AA31 J4
 AA36 J3
 AA60 J5
 AA60-21580 J3
 AA70 J3, J5
 AA80 J5
 CU150A J2, J3

HOLLOW CONE NOZZLES

SpiralJet Standard Angle Spray

BSJ F4

WhirlJet Standard Angle Spray

AP F4
 AX F3
 BD F4
 BDM F4
 BX F3
 CF F3
 CRC F3
 CX F3
 D F3
 LAP F4
 LBP F4

WhirlJet Wide Angle Spray

AP-W F4
 AX-W F3
 BX-W F3
 LAP-W F4
 LBP-W F4



SHOWER NOZZLES

DiscJet®

25834 C8
 48284 C8
 DJ C8
 DK C8

NeedleJet

19124 C6
 20094 C7
 21280 C7
 22812 C7
 39458 C7
 48277 C7
 48460 C6
 56740 C7
 P36503 C6

ShowerJet Disc-type

27149 C4
 39350 C4
 39485 C4
 48546 C4
 50790 C4

Lock Rings

27044 C5
 28376 C5
 29676 C5
 29677 C5
 31250 C5

**ShowerJet One-piece,
High-pressure**

37337 C3
 38553 C3
 39468 C3
 73196 C3
 73227 C3

Self-cleaning

20210 C9
 20235 C9
 26225 C9
 26411 C10
 36090 C10
 38332 C10
 38490 C10

49905 C10
 72370 C10

SHOWERS

Automatic Brush B2
 PulsaJet® Manifold B2
 AutoJet® Self-Cleaning Web Lamination B3
 AutoJet Oscillator Shower Assembly B3
 Air Atomizing B4
 Pipe-in-Pipe Air Atomizing B4
 Brushless B5
 Spray Control Options B5

CHEST CLEANERS

TankJet®

9 A, B & C H6
 14 H6
 16 H5
 19 H6
 65 H4
 65HT H4
 75 H5
 78 H3, H4
 78D H4
 80 H4
 180 H4
 360 H2, H4
 6353 H3, H6
 6353-MFP H6
 8310A H8
 12900 H5
 18250A H6
 21400A H7
 23240-2 H7
 23240-3 H7
 27500 H3, H5
 27500-R H5
 28500 H5
 28500-R H5
 30473 H7
 63225 H6
 AA090 H5
 AA124/AA430 H8
 AA190 H3, H4
 AA290 H2, H4
 D26564 H6
 D26984 H5

D40159 H5
 D41800E H5
 D41892 H6
 D41990 H6
 M60 H6
 VSM H7
 YMD3 H4

Strainers

8310A H8
 AA124/AA430 H8
 TWD H8

WEB TRIMMING

Adapters

39290 Swivel Adapter D3
 87529 Air Barrier Adapter D3

Alignment Devices

115450 D4
 13802 E6
 36533-60 J4
 Y72020 D4

UltraStream Nozzles

38170 D2
 38171 D2
 48461 D2
 39610 Swivel D2
 72242 D2
 58035-2 D2
 56795-2 D2

Trimming Feed Converters

115425 D3
 115427 D3



SPRAYING SYSTEMS CO.'S TRADEMARK USAGE

The following is a current list of Spraying Systems Co.'s trademarks registered in the United States. Some marks are registered in other countries as well.

AirJet®	FloodJet®	QuickJet®	VeeJet®
AutoJet®	FogJet®	RotoClean®	WashJet®
DiscJet®	FullJet®	SpiralJet®	WhirlJet®
DripSafe™	GunJet®	TankJet®	WindJet®
FlatJet®	MiniFogger®	UniJet®	

Spraying Systems Co. reserves the right to make changes in specifications or design of the products shown in the catalog or to add improvements at anytime without notice or obligation.



PERFORMANCE DATA

PERFORMANCE DATA
INTRODUCTION

PERFORMANCE YOU CAN COUNT ON FOR ALL THE SPRAY APPLICATIONS IN YOUR PAPER MILL



PERFORMANCE DATA TABLE OF CONTENTS

CONTENTS

SHOWER NOZZLES

	STANDARD UNITS	METRIC UNITS
Showerjet One-Piece, High-Pressure	4 ▶	60 ▶
ShowerJet Disc-Type	5 ▶	61 ▶
NeedleJet®	9 ▶	65 ▶
DiscJet®	11 ▶	67 ▶
Self-cleaning	13 ▶	69 ▶

WEB-TRIMMING NOZZLES

UltraStream®	17 ▶	73 ▶
--------------	------	------

FLAT SPRAY NOZZLES

Standard Spray

VeeJet®	21 ▶	75 ▶
Quick-Change: QuickJet® and UniJet®	28 ▶	82 ▶
UniJet	35 ▶	89 ▶
Black Liquor®	39 ▶	95 ▶

Wide Angle Spray

Quick-Change: QuickJet® and UniJet®	40 ▶	96 ▶
FloodJet®	42 ▶	98 ▶

Narrow Spray

FlatJet®	44 ▶	100 ▶
Quick-Change: QuickJet	46 ▶	102 ▶

HOLLOW CONE NOZZLES

WhirlJet®	49 ▶	103 ▶
SpiralJet®	59 ▶	115 ▶



PERFORMANCE DATA

SHOWER NOZZLES
SHOWERJET ONE-PIECE, HIGH-PRESSURE

STANDARD UNITS

PERFORMANCE DATA
SOLID STREAM SPRAY: 73196, 73327, 37337, 38553, 39468

Spray Angle at 60 psi	Capacity Size	Equiv. Orifice Dia. (in.)	Flow Rate Capacity (gallons per minute)				
			20 psi	40 psi	100 psi	250 psi	800 psi
0° (solid stream)	00003	.015	.02	.03	.05	.08	.13
	00005	.020	.04	.05	.08	.13	.22
	00008	.025	.06	.08	.13	.20	.36
	00011	.030	.08	.11	.17	.28	.49
	00015	.035	.11	.15	.24	.38	.67
	00020	.040	.14	.20	.32	.50	.89
	00025	.045	.18	.25	.40	.63	1.12

Highlighted column shows the rated pressure.

DIMENSIONS

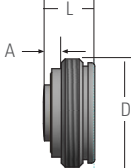
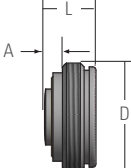
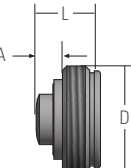
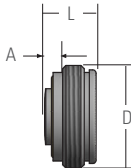
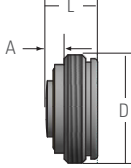
Nozzle	Nozzle Type	Thread Size	L (in.)	A (in.)	D (Dia.) (in.)
	73196-A	1-3/16"-18 or M30 x 1.5	0.66	0.27	1.19
	73196-B		0.63	0.24	
	73196-C		0.73	0.34	
	73196-D		0.60	0.21	
	73327-A	1-1/4"-18 or M32 x 1.5	0.66	0.27	1.25
	73327-B		0.63	0.24	
	73327-C		0.73	0.34	
	73327-D		0.60	0.21	
	39468-A	1-3/16"-18 or M30 x 1.5	0.76	0.27	1.38
	39468-B		0.73	0.24	
	39468-C		0.83	0.34	
	39468-D		0.70	0.21	
	37337-A	1-3/16"-18 or M30 x 1.5	0.66	0.27	1.19
	37337-B		0.63	0.24	
	37337-C		0.73	0.34	
	37337-D		0.60	0.21	
	38553-A	1-1/4"-18 or M32 x 1.5	0.66	0.27	1.25
	38553-B		0.63	0.24	
	38553-C		0.73	0.34	
	38553-D		0.60	0.21	

**PERFORMANCE DATA
FLAT SPRAY: 27149**

Spray Angle at 60 psi	Nozzle Type	Capacity Size	Equiv. Orifice Dia. (in.)	Flow Rate Capacity (gallons per minute)				
				20 psi	40 psi	100 psi	250 psi	800 psi
75°	27149	7502	.039	.16	.23	.36	.58	1.0
	•	7503	.047	.23	.33	.52	.83	1.5
	•	7504	.059	.3	.43	.68	1.1	1.9
	•	7506	.071	.43	.61	.97	1.5	2.7
	•	7508	.079	.56	.79	1.3	2.0	3.5
	•	7510	.089	.72	1.0	1.6	2.6	4.6
	•	7512	.099	.88	1.2	2.0	3.1	5.6
	•	7516	.11	1.1	1.6	2.5	4.0	7.2
	•	7520	.118	1.4	2.0	3.1	5.0	8.9
	•	7525	.138	1.8	2.6	4.1	6.4	11.5
	•	7531	.157	2.2	3.1	5.0	7.9	14.0
	•	7540	.177	2.9	4.0	6.4	10.1	18.0
	•	7549	.197	3.5	4.9	7.7	12.2	22
	•	7578	.236	5.6	7.9	12.5	19.8	35
	•	7599	.276	7.0	9.9	15.7	25	44
	•	75124	.315	8.8	12.4	19.6	31	55
60°	•	6002	.039	.16	.23	.36	.58	1.0
	•	6003	.047	.23	.33	.52	.83	1.5
	•	6004	.059	.3	.43	.68	1.1	1.9
	•	6006	.071	.43	.61	.97	1.5	2.7
	•	6008	.079	.56	.79	1.3	2.0	3.5
	•	6010	.089	.72	1.0	1.6	2.6	4.6
	•	6012	.099	.88	1.2	2.0	3.1	5.6
	•	6016	.11	1.1	1.6	2.5	4.0	7.2
	•	6020	.118	1.4	2.0	3.1	5.0	8.9
	•	6025	.138	1.8	2.6	4.1	6.4	11.5
	•	6031	.157	2.2	3.1	5.0	7.9	14.0
	•	6040	.177	2.9	4.0	6.4	10.1	18.0
	•	6049	.197	3.5	4.9	7.8	12.3	22
	•	6064	.217	4.5	6.4	10.1	16.0	28.6
	•	6078	.236	5.6	7.9	12.4	19.6	35
	•	6099	.276	7.0	9.9	15.6	25	44
•	60124	.315	8.8	12.4	19.6	31	56	
45°	•	4502	.039	.16	.23	.36	.58	1.0
	•	4503	.047	.23	.33	.52	.83	1.5
	•	4504	.059	.30	.43	.68	1.1	1.9
	•	4506	.071	.43	.61	.97	1.5	2.7
	•	4508	.079	.56	.79	1.3	2.0	3.5
	•	4510	.089	.72	1.0	1.6	2.6	4.6

Highlighted column shows the rated pressure.

PERFORMANCE DATA

SHOWER NOZZLES
SHOWERJET DISC-TYPE

STANDARD UNITS

PERFORMANCE DATA
FLAT SPRAY: 27149

Spray Angle at 60 psi	Nozzle Type	Capacity Size	Equiv. Orifice Dia. (in.)	Flow Rate Capacity (gallons per minute)				
				20 psi	40 psi	100 psi	250 psi	800 psi
45°	27149							
	•	4512	.099	.88	1.2	2.0	3.1	5.6
	•	4516	.11	1.1	1.6	2.5	4.0	7.2
	•	4520	.118	1.4	2.0	3.1	5.0	8.9
	•	4525	.138	1.8	2.6	4.1	6.4	11.5
	•	4531	.157	2.2	3.1	5.0	7.9	14.0
	•	4540	.177	2.9	4.0	6.4	10.1	18.0
	•	4549	.197	3.5	4.9	7.7	12.2	22
	•	4578	.236	5.6	7.9	12.5	19.8	35
	•	4599	.276	7.0	9.9	15.7	25	44
30°	•	45124	.315	8.8	12.4	19.6	31	55
	•	3002	.039	.16	.23	.36	.58	1.0
	•	3003	.047	.23	.33	.52	.83	1.5
	•	3004	.059	.30	.43	.68	1.1	1.9
	•	3006	.071	.43	.61	.97	1.5	2.7
	•	3008	.079	.56	.79	1.3	2.0	3.5
	•	3010	.089	.72	1.0	1.6	2.6	4.6
	•	3012	.099	.88	1.2	2.0	3.1	5.6
	•	3016	.11	1.1	1.6	2.5	4.0	7.2
	•	3020	.118	1.4	2.0	3.1	5.0	8.9
	•	3025	.138	1.8	2.6	4.1	6.4	11.5
	•	3031	.157	2.2	3.1	5.0	7.9	14.0
	•	3040	.177	2.9	4.0	6.4	10.1	18.0
	•	3049	.197	3.5	4.9	7.7	12.2	22
15°	•	3078	.236	5.6	7.9	12.5	19.8	35
	•	3099	.276	7.0	9.9	15.7	25	44
	•	30124	.315	8.8	12.4	19.6	31	55
	•	1502	.039	.16	.23	.36	.58	1.0
	•	1503	.047	.23	.33	.52	.83	1.5
	•	1504	.059	.30	.43	.68	1.1	1.9
	•	1506	.071	.43	.61	.97	1.5	2.7
	•	1508	.079	.56	.79	1.3	2.0	3.5
	•	1510	.089	.72	1.0	1.6	2.6	4.6
	•	1512	.099	.88	1.2	2.0	3.1	5.6
	•	1516	.11	1.1	1.6	2.5	4.0	7.2
	•	1520	.118	1.4	2.0	3.1	5.0	8.9
•	1525	.138	1.8	2.6	4.1	6.4	11.5	
•	1531	.157	2.2	3.1	5.0	7.9	14	

Highlighted column shows the rated pressure.



**PERFORMANCE DATA
FLAT SPRAY: 27149**

Spray Angle at 60 psi	Nozzle Type	Capacity Size	Equiv. Orifice Dia. (in.)	Flow Rate Capacity (gallons per minute)				
				20 psi	40 psi	100 psi	250 psi	800 psi
15°	27149	1540	.177	2.9	4.0	6.4	10.1	18.0
	•	1549	.197	3.5	4.9	7.7	12.2	22
	•	1578	.236	5.6	7.9	12.5	19.8	35
	•	1599	.276	7.0	9.9	15.7	25	44
	•	15124	.315	8.8	12.4	19.6	31	55
0° (solid stream)	•	00004	.018	.03	.04	.06	.10	.18
	•	00007	.023	.05	.07	.11	.18	.31
	•	00009	.026	.06	.09	.14	.23	.40
	•	0001	.031	.09	.13	.21	.33	.58
	•	00015	.035	.11	.15	.24	.38	.67
	•	0002	.043	.16	.23	.36	.58	1.0
	•	0003	.053	.23	.33	.52	.83	1.5
	•	0004	.06	.30	.43	.68	1.1	1.9
	•	0006	.07	.43	.61	.97	1.5	2.7
	•	0008	.077	.56	.79	1.3	2.0	3.5
	•	0010	.085	.72	1.0	1.6	2.6	4.6
	•	0012	.096	.88	1.2	2.0	3.1	5.6
	•	0020	.125	1.4	2.0	3.1	5.0	8.9





Highlighted column shows the rated pressure.

**PERFORMANCE DATA
SOLID STREAM SPRAY: 39350, 48546, 50790, 39485**

Spray Angle at 60 psi	Capacity Size	Equiv. Orifice Dia. (in.)	Flow Rate Capacity (gallons per minute)				
			20 psi	40 psi	100 psi	250 psi	800 psi
0° (solid stream)	00003	.015	.02	.03	.05	.08	.13
	00005	.020	.04	.05	.08	.13	.22
	00008	.025	.06	.08	.13	.20	.36
	00011	.030	.08	.11	.17	.28	.49
	00015	.035	.11	.15	.24	.38	.67
	00020	.040	.14	.20	.32	.50	.89
	00025	.045	.18	.25	.40	.63	1.12

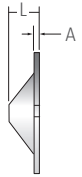
Highlighted column shows the rated pressure.

DIMENSIONS

Nozzle	Nozzle Type	L (in.)	D (Dia.) (in.)	Thickness A (in.)
	27149	0.281 (max)	1.02	0.042
	39350 and 48546	0.32	1.02	0.042
	50790	0.22	1.04	0.059
	50790-1	0.22	1.02	0.059
	39485	0.22	1.02	0.059

All ShowerJet nozzles are installed with a standard gasket which is included, CP28624-001.

ORDERING INFORMATION

Call your local spray expert for application assistance or to place an order.



PERFORMANCE DATA
SOLID STREAM: 48460, 19124, P36503, 56740, 48277, 21280, 39458, 22812, 20094

Capacity Size	Equiv. Orifice Dia. (in.)	Flow Rate Capacity (gallons per minute)								
		40 psi	60 psi	80 psi	100 psi	200 psi	400 psi	600 psi	800 psi	1000 psi
14	.014	.032	.036	.04	.043	.065	.094	.11	.13	.14
28	.028	.11	.13	.15	.17	.24	.33	.43	.48	.50
33	.033	.16	.20	.22	.25	.36	.52	.63	.75	.82
40	.040	.23	.28	.32	.36	.50	.68	.88	1.0	1.2
55	.055	.40	.48	.58	.67	.91	1.3	1.5	1.75	2.0
70	.070	.67	.84	.98	1.1	1.6	2.3	2.8	3.1	3.5
94	.094	1.2	1.45	1.6	1.8	2.5	4.0	4.6	5.5	6.5
125	.125	1.95	2.45	2.7	2.8	4.4	6.0	7.5	10.0	11.0

ORDERING INFORMATION

Call your local spray expert for application assistance or to place an order.

DIMENSIONS

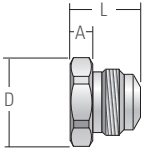
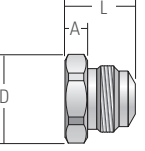
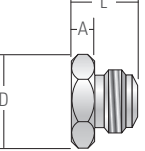
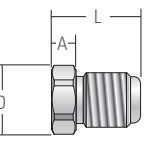
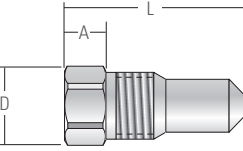
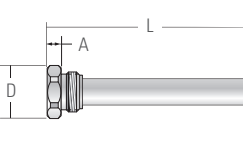
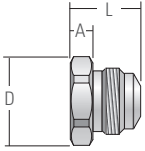
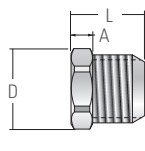
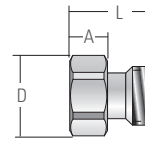
Nozzle	Nozzle Type	Conn. Thread Size (in.)	L (in.)	A (in.)	Hex. (in.)	D (Dia.) (in.)
	48460	9/16"-24 NEF	0.555	0.193	11/16	0.75
	19124	9/16"-24 NEF	0.555	0.193	11/16	0.75
	P36503	1/4" BSPP	0.555	0.193	11/16	0.75
	56740	1/8" BSPP	0.64	0.170	7/16	0.484
	48277	1/8"	1.125	0.250	7/16	0.484
	21280	9/16"-24 NEF	Varies	0.193	11/16	0.75
	39458	9/16"-24 NEF	0.555	0.193	11/16	0.75
	22812	1/8"	0.440	0.130	7/16	0.484
	20094	1/4"-28 UNF	0.440	0.160	5/16	0.343

**PERFORMANCE DATA
FLAT & SOLID STREAM SPRAY: DK, DJ, 48284, 25834**

Spray Angle at 40 psi	Nozzle Type				Capacity Size	Equiv. Orifice Dia. (in.)	Flow Rate Capacity (gallons per minute)							
	DK	DJ	48284	25834			10 psi	20 psi	30 psi	40 psi	60 psi	80 psi	100 psi	150 psi
110°		•			11006	–	.30	.42	.52	.60	.74	.85	.95	1.2
95°		•			9504	–	.20	.28	.35	.40	.49	.57	.63	.77
90°	•	•			9001	–	.05	.07	.086	.10	.12	.14	.16	.19
	•	•			90016	.031	.08	.11	.14	.16	.20	.23	.25	.31
	•	•			90026	–	.13	.18	.23	.26	.32	.37	.41	.49
	•	•			90054	.062	.27	.38	.47	.54	.66	.76	.85	1.0
	•	•			9013	.093	.65	.93	1.1	1.3	1.6	1.8	2.1	2.5
	•	•			9024	.125	1.2	1.7	2	2.4	2.9	3.3	3.7	4.6
80°	•	•			80032	.046	.16	.23	.28	.32	.39	.45	.51	.62
	•	•			80054	.062	.27	.38	.47	.54	.66	.76	.85	1.0
	•	•			8008	.076	.40	.56	.69	.80	.98	1.1	1.2	1.5
	•	•			80084	.076	.42	.59	.73	.84	1.0	1.2	1.3	1.6
	•	•			8013	.093	.66	.93	1.1	1.3	1.6	1.8	2.0	2.5
	•	•			8024	.125	1.2	1.7	2.0	2.4	2.9	3.3	3.7	4.6
	•	•			8033	.156	1.7	2.3	2.9	3.3	4.0	4.7	5.2	6.4
	•	•			8035	–	1.8	2.5	3.1	3.5	4.3	5.0	5.5	6.8
70°	•	•			8054	.187	2.7	3.8	4.7	5.4	6.6	7.6	8.5	10.0
	•	•			70023	.040	.12	.16	.20	.23	.28	.33	.36	.45
68°	•	•			6824	.125	1.2	1.7	2.0	2.4	2.9	3.3	3.7	4.6
	•	•			6840	–	2.0	2.8	3.5	4.0	4.9	5.7	6.3	7.7
	•	•			6870	.218	3.5	4.9	6.1	7.0	8.6	9.9	11.1	13.6
65°	•	•			650050	–	.025	.035	.043	.05	.061	.071	.079	.097
	•	•			65054	.062	.27	.38	.47	.54	.66	.76	.85	1.0
	•	•			6513	.093	.66	.93	1.1	1.3	1.6	1.8	2.0	2.5
	•	•			6519	.111	.95	1.3	1.6	1.9	2.3	2.7	3.0	3.7
	•	•			6533	.156	1.7	2.3	2.9	3.3	4.0	4.7	5.2	6.4
	•	•			6550	.187	2.5	3.5	4.3	5.0	6.1	7.1	7.9	9.7
	•	•			6570	.218	3.5	4.9	6.1	7.0	8.6	9.9	11.1	13.6
	•	•			6585	–	4.3	6.0	7.5	8.5	10.4	12.0	13.5	16.5
60°	•	•			60054	.062	.27	.38	.47	.54	.66	.76	.85	1.0
58°	•	•			5824	.125	1.2	1.7	2.0	2.4	2.9	3.3	3.7	4.6
	•	•			5833	.156	1.7	2.3	2.9	3.3	4.0	4.7	5.2	6.4
55°	•	•			55054	.062	.27	.38	.47	.54	.66	.76	.84	1.0
	•	•			5508	.076	.40	.57	.69	.80	.98	1.1	1.2	1.5
50°	•	•			50033	.046	.17	.23	.29	.33	.40	.47	.52	.64
	•	•			50084	–	.42	.59	.73	.84	1.0	1.2	1.3	1.6
	•	•			5013	–	.66	.93	1.1	1.3	1.6	1.8	2.0	2.5
	•	•			5024	.125	1.2	1.7	2.0	2.4	2.9	3.3	3.7	4.6

Highlighted column shows the rated pressure.







PERFORMANCE DATA
SOLID STREAM SPRAY: DK, DJ, 48284, 25834

Spray Angle at 40 psi	Nozzle Type				Capacity Size	Equiv. Orifice Dia. (in.)	Flow Rate Capacity (gallons per minute)							
	DK	DJ	48284	25834			10 psi	20 psi	30 psi	40 psi	60 psi	80 psi	100 psi	150 psi
50°	•	•			5033	.156	1.7	2.3	2.9	3.3	4.0	4.7	5.2	6.4
	•	•			5037	—	1.9	2.6	3.2	3.7	4.5	5.2	5.9	7.2
	•	•			5040	—	2.0	2.8	3.5	4.0	4.9	5.7	6.3	7.7
	•	•			5050	—	2.5	3.5	4.3	5.0	6.1	7.1	7.9	9.7
43°	•	•			4308	.076	.40	.57	.69	.80	.98	1.1	1.2	1.5
	•	•			4313	.093	.66	.93	1.1	1.3	1.6	1.8	2.0	2.5
40°	•	•			4024	.125	1.2	1.7	2.0	2.4	2.9	3.3	3.7	4.6
	•	•			4047	.187	2.4	3.3	4.1	4.7	5.8	6.6	7.4	9.1
	•	•			4070	.218	3.5	4.9	6.1	7.0	8.6	9.9	11.1	13.6
	•	•			4085	.250	4.3	6.0	7.4	8.5	10.4	12.2	13.4	16.5
	•	•			4086	—	4.3	6.1	7.5	8.6	10.5	12.2	13.6	16.7
35°	•	•			3513	.093	.66	.93	1.1	1.3	1.6	1.8	2.0	2.5
	•	•			3580	.250	4.0	5.6	6.9	8.0	9.8	11.3	12.6	15.5
25°	•	•			2510	—	.50	.71	.86	1.0	1.2	1.4	1.6	1.9
	•	•			2524	.125	1.2	1.7	2.0	2.4	2.9	3.3	3.7	4.6
0° (solid stream)	•	•	•	•	00012	.025	.06	.08	.10	.12	.15	.17	.19	.23
	•	•	•	•	00015	.031	.07	.11	.13	.15	.18	.21	.24	.29
	•	•	•	•	00016	.034	.08	.11	.14	.16	.20	.23	.25	.31
	•	•	•	•	00023	.040	.12	.16	.20	.23	.28	.33	.36	.45
	•	•	•	•	00051	.060	.26	.36	.44	.51	.62	.72	.81	.99
	•	•	•	•	0006	.065	.30	.42	.52	.60	.73	.85	.95	1.2
	•	•	•	•	0008	.070	.40	.57	.69	.80	.98	1.1	1.3	1.6
	•	•	•	•	0024	.125	1.2	1.7	2.1	2.4	2.9	3.4	3.8	4.7
	•	•	•	•	0033	.156	1.7	2.3	2.9	3.3	4.0	4.7	5.2	6.4
	•	•			All others									

Highlighted column shows the rated pressure.

DIMENSIONS

Nozzle	Nozzle Type	Conn. Thread Size (in.)	D (Dia.) (in.)	Thickness (in.)
	DK	—	0.58	0.125
	DJ	5/8"-18	0.625	0.125
	48284	—	0.584	0.125
	25834	—	0.63	0.095

PERFORMANCE DATA
FLAT & SOLID STREAM SPRAY: 20210, 20235, 26225, 26411, 36090, 38332, 38490, 49905, 72370

Spray Angle at 40 psi	Capacity Size	Flow Rate Capacity (gallons per minute)													
		20 psi	30 psi	40 psi	50 psi	60 psi	70 psi	80 psi	90 psi	100 psi	120 psi	140 psi	180 psi	200 psi	250 psi
130°	13016	1.1	1.4	1.6	1.8	2.0	2.1	2.3	2.4	2.5	2.8	3.0	3.4	3.6	4.0
120°	12008	.57	.69	.80	.89	.98	1.0	1.1	1.2	1.3	1.4	1.5	1.7	1.8	2.0
100°	10011	.78	.95	1.1	1.2	1.3	1.4	1.5	1.6	1.7	1.9	2.1	2.3	2.5	2.8
	10020	1.4	1.7	2.0	2.2	2.4	2.6	2.8	3.0	3.2	3.5	3.7	4.2	4.5	5.0
80°	8003	.21	.26	.30	.35	.37	.40	.42	.45	.47	.52	.56	.64	.67	.75
	8005	.35	.43	.50	.56	.61	.66	.71	.75	.79	.87	.94	1.0	1.1	1.3
	8011	.78	.95	1.1	1.2	1.3	1.4	1.5	1.6	1.7	1.9	2.1	2.3	2.5	2.8
	8019	1.3	1.6	1.9	2.1	2.3	2.5	2.7	2.9	3.0	3.3	3.6	4.0	4.2	4.8
	8030	2.1	2.6	3.0	3.4	3.7	4.0	4.2	4.5	4.7	5.2	5.6	6.4	6.7	7.5
	8036	2.5	3.1	3.6	4.0	4.4	4.8	5.1	5.4	5.7	6.2	6.7	7.6	8.0	9.0
	8046	3.3	4.0	4.6	5.1	5.6	6.1	6.5	6.9	7.3	8.0	8.6	9.8	10.3	11.5
60°	6005	.35	.43	.50	.56	.61	.66	.71	.75	.79	.87	.94	1.0	1.1	1.3
	6012	.85	1.0	1.2	1.3	1.5	1.6	1.7	1.8	1.9	2.1	2.2	2.5	2.7	3.0
	6014	.99	1.2	1.4	1.6	1.7	1.9	2.0	2.1	2.2	2.4	2.6	3.0	3.1	3.5
	6016	1.1	1.4	1.6	1.8	2.0	2.1	2.3	2.4	2.5	2.8	3.0	3.4	3.6	4.0
	6020	1.4	1.7	2.0	2.2	2.4	2.6	2.8	3.0	3.2	3.5	3.7	4.2	4.5	5.0
	6025	1.8	2.2	2.5	2.8	3.1	3.3	3.5	3.8	4.0	4.3	4.7	5.3	5.6	6.3
	6031	2.2	2.7	3.1	3.5	3.8	4.1	4.4	4.7	4.9	5.4	5.8	6.6	6.9	7.8
	6038	2.7	3.3	3.8	4.2	4.7	5.0	5.4	5.7	6.0	6.6	7.1	8.1	8.5	9.5
6050	3.5	4.3	5.0	5.6	6.2	6.6	7.0	7.5	8.0	8.7	9.4	10.6	11.2	12.6	
50°	5032	2.3	2.8	3.2	3.6	3.9	4.2	4.5	4.8	5.1	5.5	6.0	6.8	7.2	8.0
45°	4516	1.1	1.4	1.6	1.8	2.0	2.1	2.3	2.4	2.5	2.8	3.0	3.4	3.6	4.0
	4525	1.8	2.2	2.5	2.8	3.1	3.3	3.5	3.8	4.0	4.3	4.7	5.3	5.6	6.3
	4542	3.0	3.6	4.2	4.7	5.1	5.6	5.9	6.3	6.6	7.3	7.9	8.9	9.4	10.5
40°	4008	.56	.69	.80	.89	.98	1.0	1.1	1.2	1.3	1.4	1.5	1.7	1.8	2.0
	4012	.85	1.0	1.2	1.3	1.5	1.6	1.7	1.8	1.9	2.1	2.2	2.5	2.7	3.0
	4013	.92	1.1	1.3	1.5	1.6	1.7	1.8	2.0	2.1	2.3	2.4	2.8	2.9	3.3
	4014	.99	1.2	1.4	1.6	1.7	1.9	2.0	2.1	2.2	2.4	2.6	3.0	3.1	3.5
	4020	1.4	1.7	2.0	2.2	2.4	2.6	2.8	3.0	3.2	3.5	3.7	4.2	4.5	5.0
	4032	2.3	2.8	3.2	3.6	3.9	4.2	4.5	4.8	5.1	5.5	6.0	6.8	7.2	8.0
	4045	3.2	3.9	4.5	5.0	5.5	6.0	6.4	6.8	7.1	7.8	8.4	9.5	10.1	11.3
30°	3005	.35	.43	.50	.56	.61	.66	.71	.75	.79	.87	.94	1.0	1.1	1.3
	3013	.92	1.1	1.3	1.5	1.6	1.7	1.8	2.0	2.1	2.3	2.4	2.8	2.9	3.3
	3014	.99	1.2	1.4	1.6	1.7	1.9	2.0	2.1	2.2	2.4	2.6	3.0	3.1	3.5
	3040	2.8	3.5	4.0	4.5	4.9	5.3	5.7	6.0	6.3	6.9	7.5	8.5	8.9	10.0
20°	2012	.85	1.0	1.2	1.3	1.5	1.6	1.7	1.8	1.9	2.1	2.2	2.5	2.7	3.0
15°	1506	.42	.52	.60	.67	.73	.79	.85	.90	.95	1.0	1.1	1.2	1.3	1.5

Highlighted column shows the rated pressure.



PERFORMANCE DATA

FLAT & SOLID STREAM SPRAY: 20210, 20235, 26225, 26411, 36090, 38332, 38490, 49905, 72370

Spray Angle at 40 psi	Capacity Size	Flow Rate Capacity (gallons per minute)													
		20 psi	30 psi	40 psi	50 psi	60 psi	70 psi	80 psi	90 psi	100 psi	120 psi	140 psi	180 psi	200 psi	250 psi
0° (solid stream)	000012	.008	.010	.012	.013	.015	.016	.017	.018	.019	.021	.022	.025	.027	.03
	000026	.018	.022	.026	.029	.032	.034	.037	.039	.041	.045	.048	.055	.058	.065
	000053	.037	.046	.053	.059	.065	.07	.075	.079	.083	.092	.099	.11	.12	.13
	00007	.049	.061	.070	.078	.085	.092	.099	.10	.11	.12	.13	.15	.17	.18
	0001	.072	.088	.10	.11	.12	.13	.14	.15	.16	.18	.19	.22	.23	.26
	00017	.12	.15	.17	.19	.20	.22	.24	.25	.27	.29	.31	.35	.37	.42
	0002	.14	.17	.20	.22	.25	.26	.28	.30	.32	.35	.37	.42	.45	.5
	00025	.18	.22	.25	.29	.31	.34	.36	.38	.40	.44	.48	.54	.57	.64
	00032	.23	.28	.32	.36	.39	.42	.45	.48	.51	.56	.60	.68	.72	.80
	00043	.31	.38	.44	.49	.53	.58	.62	.65	.69	.75	.81	.92	.97	1.1
	0005	.35	.43	.50	.56	.61	.66	.71	.75	.79	.87	.94	1.0	1.1	1.3
	0006	.42	.52	.60	.67	.73	.79	.85	.90	.95	1.0	1.1	1.2	1.3	1.5
	0008	.56	.69	.80	.89	.98	1.0	1.1	1.2	1.3	1.4	1.5	1.7	1.8	2.0
	0010	.71	.86	1.0	1.1	1.2	1.3	1.4	1.5	1.6	1.7	1.9	2.1	2.2	2.5

Highlighted column shows the rated pressure.

ORDERING INFORMATION

Call your local spray expert for application assistance or to place an order.



DIMENSIONS

Nozzle	Nozzle Type	Conn. Thread Size (in.)	Length in.	D (Dia.) in.	Hex. in.
	20210	1-1/8"-20 UN	1.63	1.66	1-1/2
	20235	3/4"-20 UNEF	1.40	1.25	1
	26225	3/4"-20 UNEF	1.40	1.09	1
	26411	3/4" BSPP	1.38	1.66	1-1/2
	36090	M28 x 1.5	1.63	1.66	1-1/2
	38332	3/4"	1.54	1.17	1-1/16
	38490	1-1/8"-20 UN	1.63	1.66	1-1/2

STANDARD UNITS

DIMENSIONS

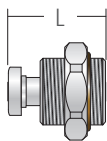
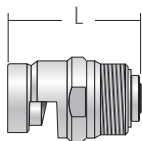
Nozzle	Nozzle Type	Conn. Thread Size (in.)	Length in.	D (Dia.) in.	Hex. in.
	49905	1-1/8"-20 UN	1.63	1.66	1-1/2
	49905-1	M28 x 1.5	1.63	1.66	1-1/2
	72370	1/2"	1.39	0.875	.812 flats

ORDERING INFORMATION

Call your local spray expert for application assistance or to place an order.

PERFORMANCE DATA
SOLID STREAM SPRAY: 38170, 38171, 48461, 72242, 39610

Nozzle Type/ Conn. Size (in.)					Capacity Size	Equiv. Orifice Dia. (in.)	Flow Rate Capacity (gallons per minute)					
38170	38171	48461	72242	39610			100 psi	200 psi	400 psi	600 psi	800 psi	1000 psi
3/8	1/8	1/8	1/8	M10								
				•	10	.010	.02	.02	.03	.04	.05	.06
•	•	•	•	•	15	.015	.04	.06	.09	.11	.13	.14
•	•	•	•	•	20	.020	.08	.11	.16	.20	.23	.25
•	•	•	•	•	25	.025	.12	.18	.25	.31	.35	.40
				•	27.5	.0275	.15	.20	.29	.35	.40	.45
•	•	•	•	•	30	.030	.18	.25	.36	.44	.51	.57
				•	32	.032	.20	.28	.39	.47	.54	.61
•	•	•	•	•	35	.035	.24	.35	.49	.60	.69	.77
•	•	•	•	•	40	.040	.32	.45	.64	.78	.90	1.0
•	•	•	•	•	45	.045	.40	.57	.81	.99	1.2	1.3
•	•				50	.050	.50	.71	1.0	1.2	1.4	1.6
•	•				60	.060	.72	1.0	1.4	1.8	2.0	2.3

48461 and 72242 are only available with ruby orifice.

PERFORMANCE DATA
SOLID STREAM SPRAY: 58035-2, 56795-2

Conn. Size (in.)	Nozzle Type		Capacity Size	Equiv. Orifice Dia. (in.)	Flow Rate Capacity (gallons per minute)					
	58035-2	56795-2			100 psi	200 psi	400 psi	600 psi	800 psi	1000 psi
1/8	•	•	10	.010	.04	.05	.08	.09	.11	.12
	•	•	15	.015	.09	.13	.18	.22	.26	.29
	•	•	20	.020	.16	.23	.33	.40	.46	.51
	•	•	25	.025	.24	.34	.48	.59	.68	.76
	•	•	30	.030	.36	.51	.72	.88	1.02	1.14
	•	•	35	.035	.48	.68	.96	1.18	1.36	1.52

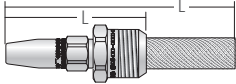
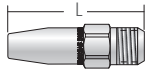
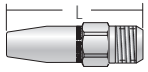
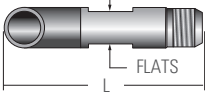
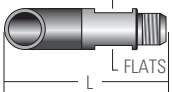
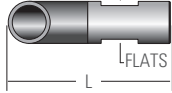
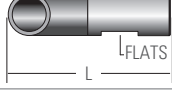

DIMENSIONS

Nozzle	Nozzle Type	Conn. Size /Type (in.)	L (in.)	D (Dia.) (in.)	Hex./Flats (in.)
	38170	3/8 male	1.53 with strainer 3.38	0.83	3/4
	38171	1/8 male	1.54	0.48	7/16
	48461	1/8 male	1.54	0.48	7/16
	72242	1/8 male	2.10	0.42	0.33
	39610	M10 x 0.75 male	2.45	0.55	0.40
	56795-2	1/8 male/female	2.10	0.53	0.43
	58035-2	1/8 male	2.00	0.53	0.53

ULTRASTREAM ACCESSORY DIMENSIONS

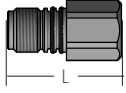
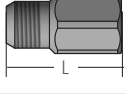
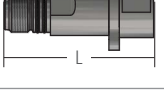
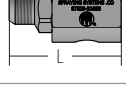
Nozzle	Nozzle Type	Conn. Size /Type (in.)	Outlet Thread Size /Type (in.)	L (in.)	D (Dia.) (in.)	Hex./Flats (in.)
	115425	M10	1/8 female	1.03	–	0.5
	115427	1/8 male	M10 female	1.00	–	0.5
	39290	M10 x 0.75 male	1/8" female	1.71	0.52	0.47, 0.40 Flats
	87529	1/8, 1/4 M10 x 0.75	1/8 M10 x 0.75	1.93	0.98	0.83 Flats 0.75 Hex

**PERFORMANCE DATA
STANDARD ANGLE SPRAY: H-VV, H-VVL AND H-DT**

Spray Angle at 40 psi	Nozzle Type/ Conn. Size (in.)						Capacity Size	Equiv. Orifice Dia. (in.)	Flow Rate Capacity (gallons per minute)									Spray Angle (°)			
	H-VV		H-VVL		H-DT				5 psi	10 psi	20 psi	40 psi	80 psi	100 psi	200 psi	300 psi	500 psi	20 psi	40 psi	80 psi	200 psi
	1/8	1/4	1/8	1/4	1/8	1/4															
110°	•	•	•	•			01	.026	.035	.05	.07	.10	.14	.16	.22	.27	.35	94	110	121	124
	•	•	•	•			015	.032	.05	.08	.11	.15	.21	.24	.34	.41	.53	97	110	121	124
	•	•	•	•		•	02	.035	.07	.10	.14	.20	.28	.32	.45	.55	.71	98	110	120	123
	•	•	•	•		•	03	.043	.11	.15	.21	.30	.42	.47	.67	.82	1.1	99	110	120	123
	•	•	•	•	•	•	04	.050	.14	.20	.28	.40	.57	.63	.89	1.1	1.4	100	110	119	122
	•	•	•	•		•	05	.056	.18	.25	.35	.50	.71	.79	1.1	1.4	1.8	100	110	118	122
	•	•	•	•	•	•	06	.061	.21	.30	.42	.60	.85	.95	1.3	1.6	2.1	101	110	117	122
	•	•	•	•		•	08	.071	.28	.40	.57	.80	1.1	1.3	1.8	2.2	2.8	102	110	117	121
	•	•	•	•	•	•	10	.079	.35	.50	.71	1.0	1.4	1.6	2.2	2.7	3.5	103	110	117	119
	•	•	•	•		•	15	.094	.53	.75	1.1	1.5	2.1	2.4	3.4	4.1	5.3	104	110	117	118
95°	•		•		•		0050	.018	–	–	.035	.050	.07	.08	.11	.14	.18	81	95	105	113
	•	•	•	•			01	.026	.035	.05	.07	.10	.14	.16	.22	.27	.35	81	95	105	113
	•		•	•			015	.032	.05	.08	.11	.15	.21	.24	.34	.41	.53	82	95	105	113
	•	•	•	•	•	•	02	.035	.07	.10	.14	.20	.28	.32	.45	.55	.71	82	95	105	113
	•	•	•	•		•	03	.043	.11	.15	.21	.30	.42	.47	.67	.82	1.1	83	95	104	111
	•	•	•	•	•	•	04	.050	.14	.20	.28	.40	.57	.63	.89	1.1	1.4	84	95	103	108
	•	•	•	•	•		05	.056	.18	.25	.35	.50	.71	.79	1.1	1.4	1.8	84	95	102	107
	•	•	•	•	•	•	06	.061	.21	.30	.42	.60	.85	.95	1.3	1.6	2.1	86	95	101	106
	•				•		065	.064	.23	.33	.46	.65	.92	1.0	1.5	1.8	2.3	86	95	101	106
•	•	•	•	•	•	08	.071	.28	.40	.57	.80	1.1	1.3	1.8	2.2	2.8	87	95	100	105	
80°	•	•	•	•			0050	.018	–	–	.035	.050	.07	.08	.11	.14	.18	61	80	95	101
	•	•	•	•			0067	.021	–	.033	.05	.067	.09	.11	.15	.18	.24	67	80	94	99
	•	•	•	•	•	•	01	.026	–	.05	.07	.10	.14	.16	.22	.27	.35	68	80	89	92
		•	•	•		•	015	.032	–	.08	.11	.15	.21	.24	.34	.41	.53	68	80	89	92
	•	•	•	•	•	•	02	.035	.07	.10	.14	.20	.28	.32	.45	.55	.71	69	80	88	91
	•	•	•	•	•	•	03	.043	.11	.15	.21	.30	.42	.47	.67	.82	1.1	70	80	87	90
	•	•	•	•	•	•	04	.050	.14	.20	.28	.40	.57	.63	.89	1.1	1.4	71	80	86	89
	•	•	•	•	•	•	05	.056	.18	.25	.35	.50	.71	.79	1.1	1.4	1.8	71	80	86	89
	•	•	•	•	•	•	06	.061	.21	.30	.42	.60	.85	.95	1.3	1.6	2.1	72	80	85	88
	•				•	•	07	.066	.25	.35	.49	.70	.99	1.1	1.6	1.9	2.5	72	80	85	88
	•	•	•	•	•	•	08	.071	.28	.40	.57	.80	1.1	1.3	1.8	2.2	2.8	72	80	84	87
	•	•	•	•	•	09	.075	.32	.45	.64	.90	1.3	1.4	2.0	2.5	3.2	73	80	84	87	

Highlighted column shows the rated pressure.



PERFORMANCE DATA
STANDARD ANGLE SPRAY: H-VV, H-VVL AND H-DT

Spray Angle at 40 psi	Nozzle Type/ Conn. Size (in.)						Capacity Size	Equiv. Orifice Dia. (in.)	Flow Rate Capacity (gallons per minute)										Spray Angle (°)			
	H-VV		H-VVL		H-DT				5 psi	10 psi	20 psi	40 psi	80 psi	100 psi	200 psi	300 psi	500 psi	20 psi	40 psi	80 psi	200 psi	
	1/8	1/4	1/8	1/4	1/8	1/4																
73°	•	•	•	•	•		0077	.023	–	.039	.055	.077	.11	.12	.17	.21	.27	53	73	86	92	
	•	•	•	•			0154	.032	.054	.077	.11	.15	.22	.24	.34	.42	.54	55	73	84	88	
		•		•			0231	.038	.082	.12	.16	.23	.33	.37	.52	.63	.82	56	73	83	87	
	•	•	•	•			0308	.044	.11	.15	.22	.31	.44	.49	.69	.84	1.1	58	73	82	86	
		•		•			0462	.054	.16	.23	.33	.46	.65	.73	1.0	1.3	1.6	60	73	80	84	
	•		•				0770	.069	.27	.39	.54	.77	1.1	1.2	1.7	2.1	2.7	64	73	77	82	
65°	•		•				0017	.011	–	–	.012	.017	.024	.027	.038	.047	.06	44	65	77	86	
	•		•				0033	.015	–	–	.023	.033	.047	.052	.07	.09	.12	47	65	76	83	
	•	•	•	•	•		0067	.021	–	.033	.05	.067	.09	.11	.15	.18	.24	50	65	75	81	
	•	•	•	•	•	•	01	.026	–	.05	.07	.10	.14	.16	.22	.27	.35	51	65	74	80	
	•	•	•	•			015	.032	–	.08	.11	.15	.21	.24	.34	.41	.53	51	65	74	80	
	•	•	•	•	•	•	02	.035	.07	.10	.14	.20	.28	.32	.45	.55	.71	52	65	73	79	
	•		•				025	.039	.09	.13	.18	.25	.35	.40	.56	.68	.88	52	65	73	79	
	•	•	•	•	•	•	03	.043	.11	.15	.21	.30	.42	.47	.67	.82	1.1	53	65	72	78	
	•	•	•	•	•	•	04	.050	.14	.20	.28	.40	.57	.63	.89	1.1	1.4	53	65	72	76	
	•	•	•	•	•	•	05	.056	.18	.25	.35	.50	.71	.79	1.1	1.4	1.8	53	65	72	76	
		•			•	•	055	.059	.19	.28	.39	.55	.78	.87	1.2	1.5	1.9	53	65	72	76	
	•	•		•	•	•	06	.061	.21	.30	.42	.60	.85	.95	1.3	1.6	2.1	54	65	72	75	
		•			•	•	07	.066	.25	.35	.49	.70	.99	1.1	1.6	1.9	2.5	54	65	71	75	
	•	•	•	•	•	•	08	.071	.28	.40	.57	.80	1.1	1.3	1.8	2.2	2.8	55	65	71	74	
•				•	•	09	.075	.32	.45	.64	.90	1.3	1.4	2.0	2.5	3.2	55	65	71	74		
50°	•	•	•	•			01	.026	–	.05	.07	.10	.14	.16	.22	.27	.35	37	50	59	65	
	•	•	•	•			02	.035	–	.10	.14	.20	.28	.32	.45	.55	.71	39	50	57	63	
	•	•	•	•		•	03	.043	.11	.15	.21	.30	.42	.47	.67	.82	1.1	40	50	56	62	
	•	•	•	•		•	04	.050	.14	.20	.28	.40	.57	.63	.89	1.1	1.4	42	50	56	61	
	•	•	•	•		•	05	.056	.18	.25	.35	.50	.71	.79	1.1	1.4	1.8	44	50	56	61	
	•					•	055	.059	.19	.28	.39	.55	.78	.87	1.2	1.5	1.9	44	50	56	61	
	•	•	•	•		•	06	.061	.21	.30	.42	.60	.85	.95	1.3	1.6	2.1	45	50	56	60	
	•	•				•	07	.066	.25	.35	.49	.70	.99	1.1	1.6	1.9	2.5	45	50	56	60	
	•	•	•	•		•	08	.071	.28	.40	.57	.80	1.1	1.3	1.8	2.2	2.8	45	50	55	60	
		•			•	•	09	.075	.32	.45	.64	.90	1.3	1.4	2.0	2.5	3.2	45	50	55	59	
40°	•	•	•	•	•		01	.026	–	–	.07	.10	.14	.16	.22	.27	.35	26	40	52	59	
	•	•	•	•	•		015	.032	–	–	.11	.15	.21	.24	.34	.41	.53	27	40	52	59	
	•	•	•	•	•	•	02	.035	–	.10	.14	.20	.28	.32	.45	.55	.71	29	40	51	58	
	•	•	•	•	•	•	03	.043	–	.15	.21	.30	.42	.47	.67	.82	1.1	30	40	50	57	
	•	•	•	•	•	•	04	.050	–	.20	.28	.40	.57	.63	.89	1.1	1.4	30	40	50	56	

Highlighted column shows the rated pressure.



**PERFORMANCE DATA
STANDARD ANGLE SPRAY: H-VV, H-VVL AND H-DT**

Spray Angle at 40 psi	Nozzle Type/ Conn. Size (in.)						Capacity Size	Equiv. Orifice Dia. (in.)	Flow Rate Capacity (gallons per minute)										Spray Angle (°)			
	H-VV		H-VVL		H-DT				5 psi	10 psi	20 psi	40 psi	80 psi	100 psi	200 psi	300 psi	500 psi	20 psi	40 psi	80 psi	200 psi	
	1/8	1/4	1/8	1/4	1/8	1/4																
40°	•	•	•	•	•	•	05	.056	–	.25	.35	.50	.71	.79	1.1	1.4	1.8	31	40	49	55	
	•	•			•	•	055	.059	–	.28	.39	.55	.78	.87	1.2	1.5	1.9	31	40	49	55	
	•	•	•	•	•	•	06	.061	–	.30	.42	.60	.85	.95	1.3	1.6	2.1	31	40	49	55	
	•	•			•	•	065	.064	–	.33	.46	.65	.92	1.0	1.5	1.8	2.3	31	40	48	54	
	•	•			•	•	07	.066	–	.35	.49	.70	.99	1.1	1.6	1.9	2.5	31	40	48	54	
	•	•	•	•	•	•	08	.071	.28	.40	.57	.80	1.1	1.3	1.8	2.2	2.8	31	40	47	53	
	•						085	.073	.30	.43	.60	.85	1.2	1.3	1.9	2.3	3.0	32	40	46	50	
	•	•			•	•	09	.075	.32	.45	.64	.90	1.3	1.4	2.0	2.5	3.2	32	40	46	50	
25°	•	•	•	•	•		01	.026	–	–	.07	.10	.14	.16	.22	.27	.35	14	25	34	42	
	•	•	•	•	•	•	02	.035	–	–	.14	.20	.28	.32	.45	.55	.71	15	25	33	40	
	•	•	•	•	•	•	03	.043	–	–	.21	.30	.42	.47	.67	.82	1.1	15	25	33	40	
	•	•	•	•	•	•	04	.050	–	.20	.28	.40	.57	.63	.89	1.1	1.4	1.6	16	25	32	39
				•	•	•	045	.053	–	.23	.32	.45	.64	.71	1.0	1.2	1.6	16	25	32	39	
	•	•	•	•	•	•	05	.056	–	.25	.35	.50	.71	.79	1.1	1.4	1.8	16	25	32	39	
	•	•			•	•	055	.059	–	.28	.39	.55	.78	.87	1.2	1.5	1.9	16	25	31	38	
	•	•	•	•	•	•	06	.061	–	.30	.42	.60	.85	.95	1.3	1.6	2.1	17	25	31	38	
	•	•			•	•	065	.064	–	.33	.46	.65	.92	1.0	1.5	1.8	2.3	17	25	31	38	
	•	•	•		•	•	07	.066	–	.35	.49	.70	.99	1.1	1.6	1.9	2.5	17	25	31	38	
	•	•					075	.068	–	.38	.53	.75	1.1	1.2	1.7	2.1	2.7	17	25	31	38	
	•	•	•	•	•	•	08	.071	–	.40	.57	.80	1.1	1.3	1.8	2.2	2.8	17	25	31	38	
	•						085	.073	–	.43	.60	.85	1.2	1.3	1.9	2.3	3.0	18	25	31	37	
	•	•			•	•	09	.075	–	.45	.64	.90	1.3	1.4	2.0	2.5	3.2	17	25	31	37	
				•		15	.094	–	.75	1.1	1.5	2.1	2.4	3.4	4.1	5.3	18	25	31	37		
15°	•	•		•			01	.026	–	–	–	.10	.14	.16	.22	.27	.35	–	15	24	28	
	•		•		•	•	02	.035	–	–	.14	.20	.28	.32	.45	.55	.71	6	15	22	27	
	•	•	•	•	•	•	03	.043	–	–	.21	.30	.42	.47	.67	.82	1.1	6	15	22	27	
	•	•	•	•	•	•	04	.050	–	–	.28	.40	.57	.63	.89	1.1	1.4	7	15	21	26	
	•	•	•	•	•	•	05	.056	–	–	.35	.50	.71	.79	1.1	1.4	1.8	7	15	21	26	
	•	•			•	•	055	.059	–	.28	.39	.55	.78	.87	1.2	1.5	1.9	7	15	21	26	
	•	•	•	•	•	•	06	.061	–	.30	.42	.60	.85	.95	1.3	1.6	2.1	8	15	21	26	
	•	•			•	•	065	.064	–	.33	.46	.65	.92	1.0	1.5	1.8	2.3	8	15	20	25	
		•			•	•	07	.066	–	.35	.49	.70	.99	1.1	1.6	1.9	2.5	8	15	20	25	
	•	•	•	•	•	•	08	.071	–	.40	.57	.80	1.1	1.3	1.8	2.2	2.8	9	15	20	25	
	•	•			•	•	085	.073	–	.43	.60	.85	1.2	1.3	1.9	2.3	3.0	9	15	19	24	
	•	•			•	•	09	.075	–	.45	.64	.90	1.3	1.4	2.0	2.5	3.2	9	15	19	24	

Highlighted column shows the rated pressure.



PERFORMANCE DATA

FLAT SPRAY
VEEJET® NOZZLES

STANDARD UNITS

PERFORMANCE DATA
STANDARD ANGLE SPRAY: H-DU AND U

Spray Angle at 40 psi	Nozzle Type/ Conn. Size (in.)					Capacity Size	Equiv. Orifice Dia. (in.)	Flow Rate Capacity (gallons per minute)										Spray Angle (°)			
	H-DU		U					5 psi	10 psi	20 psi	40 psi	80 psi	100 psi	200 psi	300 psi	500 psi	20 psi	40 psi	80 psi	200 psi	
	1/8	1/4	1	1-1/4	2																
95°	•	•				10	.079	.35	.50	.71	1.0	1.4	1.6	2.2	2.7	3.5	89	95	100	105	
	•	•				15	.094	.53	.75	1.1	1.5	2.1	2.4	3.4	4.1	5.3	90	95	100	105	
		•				20	.109	.71	1.0	1.4	2.0	2.8	3.2	4.5	5.5	7.1	90	95	100	105	
	•	•				30	.133	1.1	1.5	2.1	3.0	4.2	4.7	6.7	8.2	10.6	91	95	101	105	
		•				40	.153	1.4	2.0	2.8	4.0	5.7	6.3	8.9	11.0	14.1	92	95	100	105	
		•				50	.172	1.8	2.5	3.5	5.0	7.1	7.9	11.2	13.7	17.7	93	95	99	103	
		•				60	.188	2.1	3.0	4.2	6.0	8.5	9.5	13.4	16.4	21	93	95	99	103	
80°		•				70	.203	2.5	3.5	4.9	7.0	9.9	11.1	15.7	19.2	25	93	95	99	103	
	•	•				10	.079	.35	.50	.71	1.0	1.4	1.6	2.2	2.7	3.5	73	80	84	87	
	•	•				15	.094	.53	.75	1.1	1.5	2.1	2.4	3.4	4.1	5.3	74	80	83	86	
	•	•				20	.109	.71	1.0	1.4	2.0	2.8	3.2	4.5	5.5	7.1	74	80	83	86	
	•	•				30	.133	1.1	1.5	2.1	3.0	4.2	4.7	6.7	8.2	10.6	74	80	83	86	
	•	•				40	.153	1.4	2.0	2.8	4.0	5.7	6.3	8.9	11.0	14.1	74	80	83	86	
		•				50	.172	1.8	2.5	3.5	5.0	7.1	7.9	11.2	13.7	17.7	74	80	83	85	
		•				60	.188	2.1	3.0	4.2	6.0	8.5	9.5	13.4	16.4	21	75	80	83	85	
		•				70	.203	2.5	3.5	4.9	7.0	9.9	11.1	15.7	19.2	25	75	80	83	86	
			•			500	.528	17.7	25	35	50	71	79	112	137	177	78	80	81	83	
65°			•			580	.569	21	29	41	58	82	92	130	159	205	78	80	81	83	
	•	•				10	.079	.35	.50	.71	1.0	1.4	1.6	2.2	2.7	3.5	56	65	71	74	
						12	.084	.42	.60	.85	1.2	1.7	1.9	2.7	3.3	4.2	56	65	71	73	
	•	•				15	.094	.53	.75	1.1	1.5	2.1	2.4	3.4	4.1	5.3	56	65	70	73	
	•	•				20	.109	.71	1.0	1.4	2.0	2.8	3.2	4.5	5.5	7.1	57	65	70	73	
	•	•				30	.133	1.1	1.5	2.1	3.0	4.2	4.7	6.7	8.2	10.6	58	65	69	72	
	•	•				40	.153	1.4	2.0	2.8	4.0	5.7	6.3	8.9	11.0	14.1	59	65	68	72	
		•				50	.172	1.8	2.5	3.5	5.0	7.1	7.9	11.2	13.7	17.7	60	65	68	71	
		•				60	.188	2.1	3.0	4.2	6.0	8.5	9.5	13.4	16.4	21	60	65	68	71	
	•	•				70	.203	2.5	3.5	4.9	7.0	9.9	11.1	15.7	19.2	25	60	65	68	71	
50°			•	•		500	.528	17.7	25	35	50	71	79	112	137	177	60	65	66	68	
			•			580	.569	21	29	41	58	82	92	130	159	205	61	65	66	68	
	•					02	.035	.07	.10	.14	.20	.28	.32	.45	.55	.71	39	50	57	63	
	•					03	.043	.11	.15	.21	.30	.42	.47	.67	.82	1.1	40	50	56	62	
	•					04	.050	.14	.20	.28	.40	.57	.63	.89	1.1	1.4	42	50	56	61	
	•					05	.056	.18	.25	.35	.50	.71	.79	1.1	1.4	1.8	44	50	56	61	
•					055	.059	.19	.28	.39	.55	.78	.87	1.2	1.5	1.9	44	50	56	61		
•					06	.061	.21	.30	.42	.60	.85	.95	1.3	1.6	2.1	45	50	56	60		

PERFORMANCE DATA
STANDARD ANGLE SPRAY: H-DU AND U

Spray Angle at 40 psi	Nozzle Type/ Conn. Size (in.)					Capacity Size	Equiv. Orifice Dia. (in.)	Flow Rate Capacity (gallons per minute)									Spray Angle (°)				
	H-DU		U					5 psi	10 psi	20 psi	40 psi	80 psi	100 psi	200 psi	300 psi	500 psi	20 psi	40 psi	80 psi	200 psi	
	1/8	1/4	1	1-1/4	2																
50°	•					07	.066	.25	.35	.49	.70	.99	1.1	1.6	1.9	2.5	45	50	56	60	
	•					08	.071	.28	.40	.57	.80	1.1	1.3	1.8	2.2	2.8	45	50	55	60	
	•	•				10	.079	.35	.50	.71	1.0	1.4	1.6	2.2	2.7	3.5	45	50	55	59	
	•	•				15	.094	.53	.75	1.1	1.5	2.1	2.4	3.4	4.1	5.3	45	50	55	59	
		•				20	.109	.71	1.0	1.4	2.0	2.8	3.2	4.5	5.5	7.1	45	50	55	59	
		•				30	.133	1.1	1.5	2.1	3.0	4.2	4.7	6.7	8.2	10.6	45	50	55	59	
	•	•				40	.153	1.4	2.0	2.8	4.0	5.7	6.3	8.9	11.0	14.1	46	50	54	59	
		•				50	.172	1.8	2.5	3.5	5.0	7.1	7.9	11.2	13.7	17.7	46	50	54	59	
		•				60	.188	2.1	3.0	4.2	6.0	8.5	9.5	13.4	16.4	21	46	50	54	59	
		•				70	.203	2.5	3.5	4.9	7.0	9.9	11.1	15.7	19.2	25	46	50	54	59	
				•	•		500	.528	17.7	25	35	50	71	79	112	137	177	49	50	51	54
				•			580	.569	21	29	41	58	82	92	130	159	205	49	50	51	53
					•		750	.647	27	38	53	75	106	119	168	205	265	49	50	51	53
					•		1000	.747	35	50	71	100	141	158	224	274	354	49	50	51	53
				•		1500	.915	53	75	106	150	212	237	335	411	530	49	50	51	52	
				•		2000	1.056	71	100	141	200	283	316	447	548	707	49	50	51	52	
40°	•	•				10	.079	.35	.50	.71	1.0	1.4	1.6	2.2	2.7	3.5	32	40	45	48	
	•	•				15	.094	.53	.75	1.1	1.5	2.1	2.4	3.4	4.1	5.3	32	40	45	48	
	•	•				20	.109	.71	1.0	1.4	2.0	2.8	3.2	4.5	5.5	7.1	32	40	45	48	
	•	•				30	.133	1.1	1.5	2.1	3.0	4.2	4.7	6.7	8.2	10.6	33	40	45	48	
	•	•				40	.153	1.4	2.0	2.8	4.0	5.7	6.3	8.9	11.0	14.1	34	40	45	48	
		•				50	.172	1.8	2.5	3.5	5.0	7.1	7.9	11.2	13.7	17.7	35	40	45	48	
		•				60	.188	2.1	3.0	4.2	6.0	8.5	9.5	13.4	16.4	21	35	40	45	48	
		•				70	.203	2.5	3.5	4.9	7.0	9.9	11.1	15.7	19.2	25	35	40	45	48	
25°			•			500	.528	17.7	25	35	50	71	79	112	137	177	38	40	41	45	
	•	•				10	.079	.35	.50	.71	1.0	1.4	1.6	2.2	2.7	3.5	18	25	31	37	
	•	•				15	.094	.53	.75	1.1	1.5	2.1	2.4	3.4	4.1	5.3	18	25	31	37	
	•	•				20	.109	.71	1.0	1.4	2.0	2.8	3.2	4.5	5.5	7.1	19	25	31	37	
	•	•				30	.133	1.1	1.5	2.1	3.0	4.2	4.7	6.7	8.2	10.6	20	25	30	36	
	•	•				40	.153	1.4	2.0	2.8	4.0	5.7	6.3	8.9	11.0	14.1	21	25	29	35	
		•				50	.172	1.8	2.5	3.5	5.0	7.1	7.9	11.2	13.7	17.7	21	25	29	35	
		•				60	.188	2.1	3.0	4.2	6.0	8.5	9.5	13.4	16.4	21	22	25	29	35	
		•				70	.203	2.5	3.5	4.9	7.0	9.9	11.1	15.7	19.2	25	22	25	29	35	
				•	•		500	.528	17.7	25	35	50	71	79	112	137	177	24	25	26	29
				•		750	.647	27	38	53	75	106	119	168	205	265	24	25	26	28	
				•		1000	.747	35	50	71	100	141	158	224	274	354	24	25	26	28	

Highlighted column shows the rated pressure.



PERFORMANCE DATA

FLAT SPRAY
VEEJET® NOZZLES

STANDARD UNITS

PERFORMANCE DATA
STANDARD ANGLE SPRAY: H-DU AND U

Spray Angle at 40 psi	Nozzle Type/ Conn. Size (in.)					Capacity Size	Equiv. Orifice Dia. (in.)	Flow Rate Capacity (gallons per minute)									Spray Angle (°)				
	H-DU		U					5 psi	10 psi	20 psi	40 psi	80 psi	100 psi	200 psi	300 psi	500 psi	20 psi	40 psi	80 psi	200 psi	
	1/8	1/4	1	1-1/4	2																
15°	•	•				10	.079	.35	.50	.71	1.0	1.4	1.6	2.2	2.7	3.5	10	15	19	24	
	•	•				15	.094	.53	.75	1.1	1.5	2.1	2.4	3.4	4.1	5.3	10	15	19	24	
	•	•				20	.109	.71	1.0	1.4	2.0	2.8	3.2	4.5	5.5	7.1	10	15	19	23	
	•	•				30	.133	1.1	1.5	2.1	3.0	4.2	4.7	6.7	8.2	10.6	10	15	19	21	
	•	•				40	.153	1.4	2.0	2.8	4.0	5.7	6.3	8.9	11.0	14.1	10	15	18	21	
		•				50	.172	1.8	2.5	3.5	5.0	7.1	7.9	11.2	13.7	17.7	11	15	18	21	
		•				60	.188	2.1	3.0	4.2	6.0	8.5	9.5	13.4	16.4	21	11	15	18	21	
		•				70	.203	2.5	3.5	4.9	7.0	9.9	11.1	15.7	19.2	25	11	15	18	21	
				•		500	.528	17.7	25	35	50	71	79	112	137	177	14	15	16	17	
				•		1000	.747	35	50	71	100	141	158	224	274	354	14	15	16	17	
0°		•				03	.041	.11	.15	.21	.30	.42	.47	.67	.82	1.1	0 (solid stream)				
	•	•				04	.047	.14	.20	.28	.40	.57	.63	.89	1.1	1.4					
	•	•				05	.053	.18	.25	.35	.50	.71	.79	1.1	1.4	1.8					
	•	•				055	.055	.19	.28	.39	.55	.78	.87	1.2	1.5	1.9					
	•	•				06	.058	.21	.30	.42	.60	.85	.95	1.3	1.6	2.1					
	•	•				065	.060	.23	.33	.46	.65	.92	1.0	1.5	1.8	2.3					
	•	•				07	.062	.25	.35	.49	.70	.99	1.1	1.6	1.9	2.5					
	•	•				08	.067	.28	.40	.57	.80	1.1	1.3	1.8	2.2	2.8					
	•	•				09	.071	.32	.45	.64	.90	1.3	1.4	2.0	2.5	3.2					
	•	•				10	.075	.35	.50	.71	1.0	1.4	1.6	2.2	2.7	3.5					
		•				12	.082	.42	.60	.85	1.2	1.7	1.9	2.7	3.3	4.2					
	•	•				15	.091	.53	.75	1.1	1.5	2.1	2.4	3.4	4.1	5.3					
	•	•				20	.106	.71	1.0	1.4	2.0	2.8	3.2	4.5	5.5	7.1					
	•	•				30	.129	1.1	1.5	2.1	3.0	4.2	4.7	6.7	8.2	10.6					
		•				40	.149	1.4	2.0	2.8	4.0	5.7	6.3	8.9	11.0	14.1					
		•				50	.167	1.8	2.5	3.5	5.0	7.1	7.9	11.2	13.7	17.7					
		•				60	.183	2.1	3.0	4.2	6.0	8.5	9.5	13.4	16.4	21					
		•				70	.198	2.5	3.5	4.9	7.0	9.9	11.1	15.7	19.2	25					
			•	•		570	.558	20	29	40	57	81	90	127	156	202					
			•			1000	.739	35	50	71	100	141	158	224	274	354					
		•			1100	.775	39	55	78	110	156	174	246	301	389						
			•		1400	.875	49	70	99	140	198	221	313	383	495						
			•		1800	.992	64	90	127	180	255	285	402	493	636						
				•	2000	1.045	71	100	141	200	283	316	447	548	707						
				•	3500	1.383	124	175	247	350	495	553	783	959	1237						

Highlighted column shows the rated pressure.

DIMENSIONS AND WEIGHTS

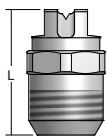
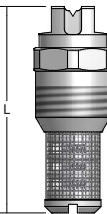
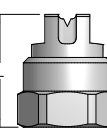
Nozzle	Nozzle Type	Conn. Size/Type (in.)	L (in.)	Hex. (in.)	D (Dia.) (in.)	Net Weight (oz.)
	H-VV	1/8 male	0.875	1/2	–	0.5
		1/4 male	0.906	9/16	–	0.8
	H-VVL	1/8 male	1.531	1/2	–	0.8
		1/4 male	1.250	9/16	–	1
	H-DT	1/8 female	0.750	1/2	–	0.5
		1/4 female	0.780	5/8	–	0.8

Based on the largest/heaviest version of each type.

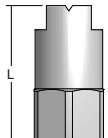
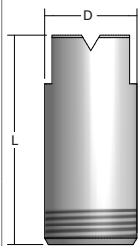
Nozzle	Nozzle Type	Conn. Size/Type (in.)	L (in.)	Hex. (in.)	D (Dia.) (in.)	Net Weight (oz.)
	H-DU	1/8 female	1.125	1/2	–	0.8
		1/4 female	1.250	5/8	–	1.3
	U	1 male	2.313	–	1.313	9
		1-1/4 male	3.750	–	1.688	20
		2 male	5.375	–	2.375	68

Based on the largest/heaviest version of each type.

STANDARD UNITS

ORDERING INFORMATION

Call your local spray expert for application assistance or to place an order.

PERFORMANCE DATA
STANDARD ANGLE SPRAY TIPS: QUA, QVVA AND 58106

Spray Angle at 40 psi	Quick VeeJet Tip Type			Capacity Size	Equiv. Orifice Dia. (in.)	Flow Rate Capacity (gallons per minute)										Spray Angle (°)			
	QUA	QVVA	58106			5 psi	10 psi	20 psi	40 psi	80 psi	100 psi	175 psi	200 psi	300 psi	20 psi	40 psi	80 psi	200 psi	
110°		●	●	01	.026	.035	.05	.07	.10	.14	.16	.21	.22	.27	94	110	121	124	
		●	●	015	.032	.05	.08	.11	.15	.21	.24	.31	.34	.41	97	110	121	124	
		●	●	02	.036	.07	.10	.14	.20	.28	.32	.42	.45	.55	98	110	120	123	
		●	●	03	.043	.11	.15	.21	.30	.42	.47	.63	.67	.82	99	110	120	123	
		●	●	04	.050	.14	.20	.28	.40	.57	.63	.84	.89	1.1	100	110	119	122	
		●	●	05	.056	.18	.25	.35	.50	.71	.79	1.0	1.1	1.4	100	110	118	122	
		●	●	06	.061	.21	.30	.42	.60	.85	.95	1.3	1.3	1.6	101	110	117	122	
		●	●	08	.071	.28	.40	.57	.80	1.1	1.3	1.7	1.8	2.2	102	110	117	121	
		●	●	10	.079	.35	.50	.71	1.0	1.4	1.6	2.1	2.2	2.7	103	110	117	119	
		●	●	15	.094	.53	.75	1.1	1.5	2.1	2.4	3.1	3.4	4.1	104	110	117	118	
	●	●	20	.109	.71	1.0	1.4	2.0	2.8	3.2	4.2	4.5	5.5	105	110	117	118		
95°		●	●	01	.026	.035	.05	.07	.10	.14	.16	.21	.22	.27	81	95	105	113	
		●	●	015	.032	.05	.08	.11	.15	.21	.24	.31	.34	.41	82	95	105	113	
		●	●	02	.036	.07	.10	.14	.20	.28	.32	.42	.45	.55	82	95	105	113	
		●	●	03	.043	.11	.15	.21	.30	.42	.47	.63	.67	.82	83	95	104	111	
		●	●	04	.050	.14	.20	.28	.40	.57	.63	.84	.89	1.1	84	95	103	108	
		●	●	05	.056	.18	.25	.35	.50	.71	.79	1.0	1.1	1.4	84	95	102	107	
		●	●	06	.061	.21	.30	.42	.60	.85	.95	1.3	1.3	1.6	86	95	101	106	
		●	●	08	.071	.28	.40	.57	.80	1.1	1.3	1.7	1.8	2.2	87	95	100	105	
		●		10	.079	.35	.50	.71	1.0	1.4	1.6	2.1	2.2	2.7	89	95	100	105	
		●		15	.094	.53	.75	1.1	1.5	2.1	2.4	3.1	3.4	4.1	90	95	100	105	
		●		20	.109	.71	1.0	1.4	2.0	2.8	3.2	4.2	4.5	5.5	90	95	100	105	
		●		30	.133	1.1	1.5	2.1	3.0	4.2	4.7	6.3	6.7	8.2	91	95	101	105	
		●		40	.153	1.4	2.0	2.8	4.0	5.7	6.3	8.4	8.9	11.0	92	95	100	105	
		●		50	.172	1.8	2.5	3.5	5.0	7.1	7.9	10.5	11.2	13.7	93	95	99	103	
	●		60	.188	2.1	3.0	4.2	6.0	8.5	9.5	12.5	13.4	16.4	93	95	99	103		
	●		70	.203	2.5	3.5	4.9	7.0	9.9	11.1	14.6	15.7	19.2	93	95	99	103		
	●	●	150	.297	5.3	7.5	10.6	15.0	21	24	31	34	41	93	95	99	102		
80°		●	●	0050	.018	-	-	.035	.050	.07	.08	.10	.11	.14	61	80	95	101	
		●	●	0067	.021	-	.033	.05	.067	.09	.11	.14	.15	.18	67	80	94	99	
		●	●	01	.026	-	.05	.07	.10	.14	.16	.21	.22	.27	68	80	89	92	
		●	●	015	.032	-	.08	.11	.15	.21	.24	.31	.34	.41	68	80	89	92	
		●	●	02	.036	.07	.10	.14	.20	.28	.32	.42	.45	.55	69	80	88	91	
		●	●	03	.043	.11	.15	.21	.30	.42	.47	.63	.67	.82	70	80	87	90	

Highlighted column shows the rated pressure.

QUICK-CHANGE NOZZLES: QUICKJET® AND UNIJET®

FLAT SPRAY

PERFORMANCE DATA

STANDARD UNITS

PERFORMANCE DATA
STANDARD ANGLE SPRAY TIPS: QUA, QVVA AND 58106

Spray Angle at 40 psi	Quick VeeJet Tip Type			Capacity Size	Equiv. Orifice Dia. (in.)	Flow Rate Capacity (gallons per minute)										Spray Angle (°)			
	QUA	QVVA	58106			5 psi	10 psi	20 psi	40 psi	80 psi	100 psi	175 psi	200 psi	300 psi	20 psi	40 psi	80 psi	200 psi	
80°		•	•	04	.050	.14	.20	.28	.40	.57	.63	.84	.89	1.1	71	80	86	89	
		•	•	05	.056	.18	.25	.35	.50	.71	.79	1.0	1.1	1.4	71	80	86	89	
		•	•	06	.061	.21	.30	.42	.60	.85	.95	1.3	1.3	1.6	72	80	85	88	
		•	•	08	.071	.28	.40	.57	.80	1.1	1.3	1.7	1.8	2.2	72	80	84	87	
	•			10	.079	.35	.50	.71	1.0	1.4	1.6	2.1	2.2	2.7	73	80	84	87	
	•			15	.094	.53	.75	1.1	1.5	2.1	2.4	3.1	3.4	4.1	74	80	83	86	
	•			20	.109	.71	1.0	1.4	2.0	2.8	3.2	4.2	4.5	5.5	74	80	83	86	
	•			30	.133	1.1	1.5	2.1	3.0	4.2	4.7	6.3	6.7	8.2	74	80	83	86	
	•			40	.153	1.4	2.0	2.8	4.0	5.7	6.3	8.4	8.9	11.0	74	80	83	86	
	•			50	.172	1.8	2.5	3.5	5.0	7.1	7.9	10.5	11.2	13.7	74	80	83	85	
	•			60	.188	2.1	3.0	4.2	6.0	8.5	9.5	12.5	13.4	16.4	75	80	83	85	
	•			70	.203	2.5	3.5	4.9	7.0	9.9	11.1	14.6	15.7	19.2	75	80	83	86	
73°		•	•	0023	.012	–	–	.016	.023	.032	.036	.05	.051	.063	50	73	89	97	
		•	•	0039	.016	–	.020	.028	.039	.055	.062	.08	.087	.11	53	73	87	93	
		•	•	0077	.023	–	.039	.055	.077	.11	.12	.16	.17	.21	53	73	86	92	
		•	•	0116	.028	.041	.058	.082	.12	.16	.18	.24	.26	.32	54	73	85	90	
		•	•	0154	.032	.054	.077	.11	.15	.22	.24	.32	.34	.42	55	73	84	88	
		•	•	0231	.038	.082	.12	.16	.23	.33	.37	.48	.52	.63	56	73	83	87	
		•	•	0308	.044	.11	.15	.22	.31	.44	.49	.64	.69	.84	58	73	82	86	
		•	•	0385	.049	.14	.19	.27	.39	.54	.61	.81	.86	1.1	59	73	81	85	
		•	•	0462	.054	.16	.23	.33	.46	.65	.73	.97	1.0	1.3	60	73	80	84	
		•	•	0616	.062	.22	.31	.44	.62	.87	.97	1.3	1.4	1.7	63	73	79	83	
		•	•	0770	.069	.27	.39	.54	.77	1.1	1.2	1.6	1.7	2.1	64	73	77	82	
		•	•	0924	.076	.33	.46	.65	.92	1.3	1.5	1.9	2.1	2.5	65	73	77	80	
65°		•	•	0017	.011	–	–	.012	.017	.024	.027	.04	.038	.047	44	65	77	86	
		•	•	0025	.013	–	–	.018	.025	.035	.040	.05	.06	.07	45	65	77	84	
		•	•	0033	.015	–	–	.023	.033	.047	.052	.07	.07	.09	47	65	76	83	
		•	•	0050	.018	–	–	.035	.050	.07	.08	.10	.11	.14	48	65	75	82	
		•	•	0067	.021	–	.033	.05	.067	.09	.11	.14	.15	.18	50	65	75	81	
		•	•	01	.026	–	.05	.07	.10	.14	.16	.21	.22	.27	51	65	74	80	
		•	•	015	.032	–	.08	.11	.15	.21	.24	.31	.34	.41	51	65	74	80	
		•	•	02	.036	.07	.10	.14	.20	.28	.32	.42	.45	.55	52	65	73	79	
		•	•	03	.043	.11	.15	.21	.30	.42	.47	.63	.67	.82	53	65	72	78	
		•	•	04	.050	.14	.20	.28	.40	.57	.63	.84	.89	1.1	53	65	72	76	
		•	•	05	.056	.18	.25	.35	.50	.71	.79	1.0	1.1	1.4	53	65	72	76	

Highlighted column shows the rated pressure.



PERFORMANCE DATA

FLAT SPRAY
QUICK-CHANGE NOZZLES: QUICKJET® AND UNIJET®

STANDARD UNITS

PERFORMANCE DATA
STANDARD ANGLE SPRAY TIPS: QUA, QVVA AND 58106

Spray Angle at 40 psi	Quick VeeJet Tip Type			Capacity Size	Equiv. Orifice Dia. (in.)	Flow Rate Capacity (gallons per minute)									Spray Angle (°)			
	QUA	QVVA	58106			5 psi	10 psi	20 psi	40 psi	80 psi	100 psi	175 psi	200 psi	300 psi	20 psi	40 psi	80 psi	200 psi
65°		●	●	06	.061	.21	.30	.42	.60	.85	.95	1.3	1.3	1.6	54	65	72	75
		●	●	08	.071	.28	.40	.57	.80	1.1	1.3	1.7	1.8	2.2	55	65	71	74
	●			10	.079	.35	.50	.71	1.0	1.4	1.6	2.1	2.2	2.7	56	65	71	74
	●			15	.094	.53	.75	1.1	1.5	2.1	2.4	3.1	3.4	4.1	56	65	70	73
	●			20	.109	.71	1.0	1.4	2.0	2.8	3.2	4.2	4.5	5.5	57	65	70	73
	●			30	.133	1.1	1.5	2.1	3.0	4.2	4.7	6.3	6.7	8.2	58	65	69	72
	●			40	.153	1.4	2.0	2.8	4.0	5.7	6.3	8.4	8.9	11.0	59	65	68	72
	●			50	.172	1.8	2.5	3.5	5.0	7.1	7.9	10.5	11.2	13.7	60	65	68	71
	●			60	.188	2.1	3.0	4.2	6.0	8.5	9.5	12.5	13.4	16.4	60	65	68	71
	●			70	.203	2.5	3.5	4.9	7.0	9.9	11.1	14.6	15.7	19.2	60	65	68	71
50°		●	●	0017	.011	–	–	.012	.017	.024	.027	.04	.038	.047	27	50	65	74
		●	●	0025	.013	–	–	.018	.025	.035	.040	.05	.06	.07	29	50	64	71
		●	●	0033	.015	–	–	.023	.033	.047	.052	.07	.07	.09	30	50	62	68
		●	●	0050	.018	–	–	.035	.050	.07	.08	.10	.11	.14	32	50	60	66
		●	●	0067	.021	–	–	.05	.067	.09	.11	.14	.15	.18	35	50	60	66
		●	●	01	.026	–	.05	.07	.10	.14	.16	.21	.22	.27	37	50	59	65
		●	●	015	.032	–	.08	.11	.15	.21	.24	.31	.34	.41	38	50	58	64
		●	●	02	.036	–	.10	.14	.20	.28	.32	.42	.45	.55	39	50	57	63
		●	●	03	.043	.11	.15	.21	.30	.42	.47	.63	.67	.82	40	50	56	62
		●	●	04	.050	.14	.20	.28	.40	.57	.63	.84	.89	1.1	42	50	56	61
		●	●	05	.056	.18	.25	.35	.50	.71	.79	1.0	1.1	1.4	44	50	56	61
		●	●	06	.061	.21	.30	.42	.60	.85	.95	1.3	1.3	1.6	45	50	56	60
		●	●	08	.071	.28	.40	.57	.80	1.1	1.3	1.7	1.8	2.2	45	50	55	60
	●			10	.079	.35	.50	.71	1.0	1.4	1.6	2.1	2.2	2.7	45	50	55	59
	●			15	.094	.53	.75	1.1	1.5	2.1	2.4	3.1	3.4	4.1	45	50	55	59
	●			20	.109	.71	1.0	1.4	2.0	2.8	3.2	4.2	4.5	5.5	45	50	55	59
	●			30	.133	1.1	1.5	2.1	3.0	4.2	4.7	6.3	6.7	8.2	45	50	55	59
	●			40	.153	1.4	2.0	2.8	4.0	5.7	6.3	8.4	8.9	11.0	46	50	54	59
	●			50	.172	1.8	2.5	3.5	5.0	7.1	7.9	10.5	11.2	13.7	46	50	54	59
	●			60	.188	2.1	3.0	4.2	6.0	8.5	9.5	12.5	13.4	16.4	46	50	54	59
●			70	.203	2.5	3.5	4.9	7.0	9.9	11.1	14.6	15.7	19.2	46	50	54	59	
40°		●	●	0017	.011	–	–	.012	.017	.024	.027	.04	.038	.047	21	40	54	61
		●	●	0025	.013	–	–	.018	.025	.035	.040	.05	.06	.07	22	40	53	60
		●	●	0033	.015	–	–	.023	.033	.047	.052	.07	.07	.09	22	40	53	60
		●	●	0050	.018	–	–	.035	.050	.07	.08	.10	.11	.14	22	40	53	60

Highlighted column shows the rated pressure.



QUICK-CHANGE NOZZLES: QUICKJET® AND UNIJET®

FLAT SPRAY

PERFORMANCE DATA

STANDARD UNITS

PERFORMANCE DATA
STANDARD ANGLE SPRAY TIPS: QUA, QVVA AND 58106

Spray Angle at 40 psi	Quick VeeJet Tip Type			Capacity Size	Equiv. Orifice Dia. (in.)	Flow Rate Capacity (gallons per minute)										Spray Angle (°)			
	QUA	QVVA	58106			5 psi	10 psi	20 psi	40 psi	80 psi	100 psi	175 psi	200 psi	300 psi	20 psi	40 psi	80 psi	200 psi	
40°		●	●	0067	.021	–	–	.05	.067	.09	.11	.14	.15	.18	24	40	53	60	
		●	●	01	.026	–	–	.07	.10	.14	.16	.21	.22	.27	26	40	52	59	
		●	●	015	.032	–	–	.11	.15	.21	.24	.31	.34	.41	27	40	52	59	
		●	●	02	.036	–	.10	.14	.20	.28	.32	.42	.45	.55	29	40	51	58	
		●	●	03	.043	–	.15	.21	.30	.42	.47	.63	.67	.82	30	40	50	57	
		●	●	04	.050	–	.20	.28	.40	.57	.63	.84	.89	1.1	30	40	50	56	
		●	●	05	.056	–	.25	.35	.50	.71	.79	1.0	1.1	1.4	31	40	49	55	
		●	●	06	.061	–	.30	.42	.60	.85	.95	1.3	1.3	1.6	31	40	49	55	
		●	●	08	.071	.28	.40	.57	.80	1.1	1.3	1.7	1.8	2.2	31	40	47	53	
		●			10	.079	.35	.50	.71	1.0	1.4	1.6	2.1	2.2	2.7	32	40	45	48
		●			15	.094	.53	.75	1.1	1.5	2.1	2.4	3.1	3.4	4.1	32	40	45	48
		●			20	.109	.71	1.0	1.4	2.0	2.8	3.2	4.2	4.5	5.5	32	40	45	48
		●			30	.133	1.1	1.5	2.1	3.0	4.2	4.7	6.3	6.7	8.2	33	40	45	48
		●			40	.153	1.4	2.0	2.8	4.0	5.7	6.3	8.4	8.9	11.0	34	40	45	48
		●			50	.172	1.8	2.5	3.5	5.0	7.1	7.9	10.5	11.2	13.7	35	40	45	48
		●			60	.188	2.1	3.0	4.2	6.0	8.5	9.5	12.5	13.4	16.4	35	40	45	48
		●			70	.203	2.5	3.5	4.9	7.0	9.9	11.1	14.6	15.7	19.2	35	40	45	48
25°		●	●	0017	.011	–	–	–	.017	.024	.027	.04	.038	.047	–	25	35	47	
		●	●	0025	.013	–	–	–	.025	.035	.040	.05	.06	.07	–	25	35	45	
		●	●	0033	.015	–	–	–	.033	.047	.052	.07	.07	.09	–	25	34	44	
		●	●	0050	.018	–	–	–	.050	.07	.08	.10	.11	.14	–	25	34	43	
		●	●	0067	.021	–	–	–	.067	.09	.11	.14	.15	.18	–	25	34	42	
		●	●	01	.026	–	–	.07	.10	.14	.16	.21	.22	.27	14	25	34	42	
		●	●	015	.032	–	–	.11	.15	.21	.24	.31	.34	.41	15	25	34	41	
		●	●	02	.036	–	–	.14	.20	.28	.32	.42	.45	.55	15	25	33	40	
		●	●	03	.043	–	–	.21	.30	.42	.47	.63	.67	.82	15	25	33	40	
		●	●	04	.050	–	.20	.28	.40	.57	.63	.84	.89	1.1	16	25	32	39	
		●	●	05	.056	–	.25	.35	.50	.71	.79	1.0	1.1	1.4	16	25	32	39	
		●	●	06	.061	–	.30	.42	.60	.85	.95	1.3	1.3	1.6	17	25	31	38	
		●	●	08	.071	–	.40	.57	.80	1.1	1.3	1.7	1.8	2.2	17	25	31	38	
		●			10	.079	–	.50	.71	1.0	1.4	1.6	2.1	2.2	2.7	18	25	31	37
		●			15	.094	–	.75	1.1	1.5	2.1	2.4	3.1	3.4	4.1	18	25	31	37
		●			20	.109	–	1.0	1.4	2.0	2.8	3.2	4.2	4.5	5.5	19	25	31	37
		●			30	.133	1.1	1.5	2.1	3.0	4.2	4.7	6.3	6.7	8.2	20	25	30	36
	●			40	.153	1.4	2.0	2.8	4.0	5.7	6.3	8.4	8.9	11.0	21	25	29	35	

Highlighted column shows the rated pressure.



PERFORMANCE DATA

FLAT SPRAY
QUICK-CHANGE NOZZLES: QUICKJET® AND UNIJET®

STANDARD UNITS

PERFORMANCE DATA
STANDARD ANGLE SPRAY TIPS: QUA, QVVA AND 58106

Spray Angle at 40 psi	Quick VeeJet Tip Type			Capacity Size	Equiv. Orifice Dia. (in.)	Flow Rate Capacity (gallons per minute)										Spray Angle (°)			
	QUA	QVVA	58106			5 psi	10 psi	20 psi	40 psi	80 psi	100 psi	175 psi	200 psi	300 psi	20 psi	40 psi	80 psi	200 psi	
25°	•			50	.172	1.8	2.5	3.5	5.0	7.1	7.9	10.5	11.2	13.7	21	25	29	35	
	•			60	.188	2.1	3.0	4.2	6.0	8.5	9.5	12.5	13.4	16.4	22	25	29	35	
	•			70	.203	2.5	3.5	4.9	7.0	9.9	11.1	14.6	15.7	19.2	22	25	29	35	
15°		•	•	0017	.011	–	–	–	.017	.024	.027	.04	.038	.047	–	15	30	37	
		•	•	0025	.013	–	–	–	.025	.035	.040	.05	.06	.07	–	15	28	34	
		•	•	0033	.015	–	–	–	.033	.047	.052	.07	.07	.09	–	15	27	32	
		•	•	0050	.018	–	–	–	.050	.07	.08	.10	.11	.14	–	15	26	30	
		•	•	0067	.021	–	–	–	.067	.09	.11	.14	.15	.18	–	15	25	29	
		•	•	01	.026	–	–	–	.10	.14	.16	.21	.22	.27	–	15	24	28	
		•	•	015	.032	–	–	–	.15	.21	.24	.31	.34	.41	–	15	23	27	
		•	•	02	.036	–	–	.14	.20	.28	.32	.42	.45	.55	6	15	22	27	
		•	•	03	.043	–	–	.21	.30	.42	.47	.63	.67	.82	6	15	22	27	
		•	•	04	.050	–	–	.28	.40	.57	.63	.84	.89	1.1	7	15	21	26	
		•	•	05	.055	–	–	.35	.50	.71	.79	1.0	1.1	1.4	7	15	21	26	
		•	•	06	.061	–	–	.42	.60	.85	.95	1.3	1.3	1.6	8	15	21	26	
		•	•	08	.071	–	–	.57	.80	1.1	1.3	1.7	1.8	2.2	9	15	20	25	
		•			10	.079	.35	.50	.71	1.0	1.4	1.6	2.1	2.2	2.7	10	15	19	24
		•			15	.094	.53	.75	1.1	1.5	2.1	2.4	3.1	3.4	4.1	10	15	19	24
		•			20	.109	.71	1.0	1.4	2.0	2.8	3.2	4.2	4.5	5.5	10	15	19	23
		•			30	.133	1.1	1.5	2.1	3.0	4.2	4.7	6.3	6.7	8.2	10	15	19	21
		•			40	.153	1.4	2.0	2.8	4.0	5.7	6.3	8.4	8.9	11.0	10	15	18	21
		•			50	.172	1.8	2.5	3.5	5.0	7.1	7.9	10.5	11.2	13.7	11	15	18	21
		•			60	.188	2.1	3.0	4.2	6.0	8.5	9.5	12.5	13.4	16.4	11	15	18	21
	•			70	.203	2.5	3.5	4.9	7.0	9.9	11.1	14.6	15.7	19.2	11	15	18	21	
0°		•	•	0009	.008	.003	.004	.005	.009	.013	.014	.020	.020	.025	0 (solid stream)				
		•	•	0012	.010	.004	.006	.008	.012	.017	.019	.027	.027	.033					
		•	•	0019	.012	.007	.009	.013	.019	.027	.030	.043	.043	.052					
		•	•	0021	.013	.007	.010	.011	.023	.033	.040	.047	.047	.052					
		•	•	0050	.019	.018	.025	.035	.050	.07	.08	.10	.11	.14					
		•	•	0067	.023	.024	.033	.05	.067	.09	.11	.14	.15	.18					
		•	•	01	.028	.035	.05	.07	.10	.14	.16	.21	.22	.27					
		•	•	015	.034	.05	.08	.11	.15	.21	.24	.31	.34	.41					
		•	•	02	.039	.07	.10	.14	.20	.28	.32	.42	.45	.55					
		•	•	03	.041	.11	.15	.21	.30	.42	.47	.63	.67	.82					
		•	•	04	.047	.14	.20	.28	.40	.57	.63	.84	.89	1.1					

Highlighted column shows the rated pressure.



QUICK-CHANGE NOZZLES: QUICKJET® AND UNIJET®

FLAT SPRAY

PERFORMANCE DATA

STANDARD UNITS

PERFORMANCE DATA
STANDARD ANGLE SPRAY TIPS: QUA, QVVA AND 58106

Spray Angle at 40 psi	Quick VeeJet Tip Type			Capacity Size	Equiv. Orifice Dia. (in.)	Flow Rate Capacity (gallons per minute)										Spray Angle (°)			
	QUA	QVVA	58106			5 psi	10 psi	20 psi	40 psi	80 psi	100 psi	175 psi	200 psi	300 psi	20 psi	40 psi	80 psi	200 psi	
0°	●	●	●	05	.053	.18	.25	.35	.50	.71	.79	1.0	1.1	1.4	0 (solid stream)				
	●	●	●	06	.058	.21	.30	.42	.60	.85	.95	1.3	1.3	1.6					
	●	●	●	08	.067	.28	.40	.57	.80	1.1	1.3	1.7	1.8	2.2					
	●			10	.075	.35	.50	.71	1.0	1.4	1.6	2.1	2.2	2.7					
	●			15	.091	.53	.75	1.1	1.5	2.1	2.4	3.1	3.4	4.1					
	●			20	.106	.71	1.0	1.4	2.0	2.8	3.2	4.2	4.5	5.5					
	●			30	.129	1.1	1.5	2.1	3.0	4.2	4.7	6.3	6.7	8.2					
	●			40	.149	1.4	2.0	2.8	4.0	5.7	6.3	8.4	8.9	11.0					
	●			50	.167	1.8	2.5	3.5	5.0	7.1	7.9	10.5	11.2	13.7					
	●			60	.183	2.1	3.0	4.2	6.0	8.5	9.5	12.5	13.4	16.4					
	●			70	.198	2.5	3.5	4.9	7.0	9.9	11.1	14.6	15.7	19.2					
	●			80	.211	2.8	4.0	5.7	8.0	11.3	12.6	16.7	17.9	22					

Highlighted column shows the rated pressure.

ASSEMBLY DIMENSIONS AND WEIGHTS

Nozzle	Tip/Body Type	Conn. Size/Type (in.)	L (in.)	Hex. (in.)	Net Weight (oz.)
	QVVA + QJA	1/8, 1/4, 3/8, 1/2 female	2.156	1	2.0
	QVVA + QJJA	1/8, 1/4, 3/8, 1/2 male	2.063	1	2.8
	QUA + QJA	1/8, 1/4, 3/8, 1/2 female	1.750	7/8	2.75
	QUA + QJJA	1/8, 1/4, 3/8, 1/2 male	1.750	7/8	2.125

Based on the largest/heaviest version of each type.

Nozzle	Tip/Body Type	Conn. Size/Type (in.)	L (in.)	Hex. (in.)	Net Weight (oz.)
	58106 - QVVA + QJA	1/8, 1/4, 3/8, 1/2 female	2.145	1	2.1

Based on the largest/heaviest version of each type.

SPRAY TIP DIMENSIONS

Nozzle	Nozzle Type	L (in.)	W (in.)
	58106*	1.250	2

*58106 fits on any QuickJet body.

PERFORMANCE DATA

FLAT SPRAY
QUICK-CHANGE NOZZLES: UNIJET®

STANDARD UNITS

PERFORMANCE DATA
STANDARD ANGLE SPRAY TIPS: 13802, TPU, 58102 AND 49803

Spray Angle at 40 psi	UniJet Tip Type				Capacity Size	Equiv. Orifice Dia. (in.)	Flow Rate Capacity (gallons per minute)										Spray Angle (°)			
	13802	TPU	58102	49803			5 psi	10 psi	20 psi	40 psi	80 psi	100 psi	200 psi	300 psi	500 psi	20 psi	40 psi	80 psi	200 psi	
110°	•	•	•		0033	.015	-	-	.023	.033	.047	.052	.07	.09	.12	91	110	116	121	
	•	•	•		0050	.018	-	-	.035	.050	.07	.08	.11	.14	.18	91	110	118	124	
	•	•	•		0067	.021	-	-	.05	.067	.09	.11	.15	.18	.24	92	110	118	124	
	•	•	•		01	.026	.035	.05	.07	.10	.14	.16	.22	.27	.35	94	110	121	124	
	•	•	•		015	.032	.05	.08	.11	.15	.21	.24	.34	.41	.53	97	110	121	124	
	•	•	•		02	.035	.07	.10	.14	.20	.28	.32	.45	.55	.71	98	110	120	123	
	•	•	•		03	.043	.11	.15	.21	.30	.42	.47	.67	.82	1.1	99	110	120	123	
	•	•	•		04	.050	.14	.20	.28	.40	.57	.63	.89	1.1	1.4	100	110	119	122	
	•	•	•		05	.056	.18	.25	.35	.50	.71	.79	1.1	1.4	1.8	100	110	118	122	
	•	•	•		06	.061	.21	.30	.42	.60	.85	.95	1.3	1.6	2.1	101	110	117	122	
	•	•	•		07	.066	.25	.35	.49	.70	.99	1.1	1.6	1.9	2.5	102	110	117	121	
	•	•	•		08	.071	.28	.40	.57	.80	1.1	1.3	1.8	2.2	2.8	102	110	117	121	
	•	•		•	10	.079	.35	.50	.71	1.0	1.4	1.6	2.2	2.7	3.5	103	110	117	119	
	•	•		•	12	.087	.42	.60	.85	1.2	1.7	1.9	2.7	3.3	4.2	103	110	117	119	
	•	•		•	15	.097	.53	.75	1.1	1.5	2.1	2.4	3.4	4.1	5.3	104	110	117	118	
	•	•		•	20	.112	.71	1.0	1.4	2.0	2.8	3.2	4.5	5.5	7.1	105	110	117	118	
	•	•		•	30	.133	1.1	1.5	2.1	3.0	4.2	4.7	6.7	8.2	10.6	105	110	117	118	
95°	•	•	•		01	.026	.035	.05	.07	.10	.14	.16	.22	.27	.35	81	95	105	113	
	•	•	•		015	.032	.05	.08	.11	.15	.21	.24	.34	.41	.53	82	95	105	113	
	•	•	•		02	.035	.07	.10	.14	.20	.28	.32	.45	.55	.71	82	95	105	113	
	•	•	•		03	.043	.11	.15	.21	.30	.42	.47	.67	.82	1.1	83	95	104	111	
	•	•	•		04	.050	.14	.20	.28	.40	.57	.63	.89	1.1	1.4	84	95	103	108	
	•	•	•		05	.056	.18	.25	.35	.50	.71	.79	1.1	1.4	1.8	84	95	102	107	
	•	•	•		06	.061	.21	.30	.42	.60	.85	.95	1.3	1.6	2.1	86	95	101	106	
	•	•	•		07	.066	.25	.35	.49	.70	.99	1.1	1.6	1.9	2.5	86	95	101	106	
	•	•	•		08	.071	.28	.40	.57	.80	1.1	1.3	1.8	2.2	2.8	87	95	100	105	
	•	•	•		09	.075	.32	.45	.64	.90	1.3	1.4	2.0	2.5	3.2	89	95	100	105	
	•	•		•	10	.079	.35	.50	.71	1.0	1.4	1.6	2.2	2.7	3.5	89	95	100	105	
	•	•		•	11	.083	.39	.55	.78	1.1	1.6	1.7	2.5	3.0	3.9	89	95	100	105	
	•	•	•		12	.087	.42	.60	.85	1.2	1.7	1.9	2.7	3.3	4.2	89	95	100	105	
	•	•	•		13	.090	.46	.65	.92	1.3	1.8	2.1	2.9	3.6	4.6	89	95	100	105	
	•	•		•	14	.093	.49	.70	.99	1.4	2.0	2.2	3.1	3.8	4.9	89	95	100	105	
	•	•		•	15	.097	.53	.75	1.1	1.5	2.1	2.4	3.4	4.1	5.3	90	95	100	105	
	•	•		•	16	.100	.57	.80	1.1	1.6	2.3	2.5	3.6	4.4	5.7	90	95	100	105	
	•	•		•	18	.106	.64	.90	1.3	1.8	2.5	2.8	4.0	4.9	6.4	90	95	100	105	
	•	•		•	20	.112	.71	1.0	1.4	2.0	2.8	3.2	4.5	5.5	7.1	90	95	100	105	
	•	•		•	30	.133	1.1	1.5	2.1	3.0	4.2	4.7	6.7	8.2	10.6	91	95	101	105	
•	•		•	40	.153	1.4	2.0	2.8	4.0	5.7	6.3	8.9	11.0	14.1	92	95	100	105		
•	•		•	50	.172	1.8	2.5	3.5	5.0	7.1	7.9	11.2	13.7	17.7	93	95	99	103		
•	•		•	60	.188	2.1	3.0	4.2	6.0	8.5	9.5	13.4	16.4	21	93	95	99	103		
•	•		•	70	.203	2.5	3.5	4.9	7.0	9.9	11.1	15.7	19.2	25	93	95	99	103		

Other body types may be available. Contact your sales engineer for further information.

Highlighted column shows the rated pressure.



PERFORMANCE DATA
STANDARD ANGLE SPRAY TIPS: 13802, TPU, 58102 AND 49803

Spray Angle at 40 psi	UniJet Tip Type				Capacity Size	Equiv. Orifice Dia. (in.)	Flow Rate Capacity (gallons per minute)										Spray Angle (°)			
	13802	TPU	58102	49803			5 psi	10 psi	20 psi	40 psi	80 psi	100 psi	200 psi	300 psi	500 psi	20 psi	40 psi	80 psi	200 psi	
80°	•	•	•		0050	.018	–	–	.035	.050	.07	.08	.11	.14	.18	61	80	95	101	
	•	•	•		0067	.021	–	.033	.05	.067	.09	.11	.15	.18	.24	67	80	94	99	
	•	•	•		01	.026	–	.05	.07	.10	.14	.16	.22	.27	.35	68	80	89	92	
	•	•	•		015	.032	–	.08	.11	.15	.21	.24	.34	.41	.53	68	80	89	92	
	•	•	•		02	.035	.07	.10	.14	.20	.28	.32	.45	.55	.71	69	80	88	91	
	•	•	•		03	.043	.11	.15	.21	.30	.42	.47	.67	.82	1.1	70	80	87	90	
	•	•	•		04	.050	.14	.20	.28	.40	.57	.63	.89	1.1	1.4	71	80	86	89	
	•	•	•		045	.053	.16	.23	.32	.45	.64	.71	1.0	1.2	1.6	71	80	86	89	
	•	•	•		05	.056	.18	.25	.35	.50	.71	.79	1.1	1.4	1.8	71	80	86	89	
	•	•	•		06	.061	.21	.30	.42	.60	.85	.95	1.3	1.6	2.1	72	80	85	88	
	•	•	•		07	.066	.25	.35	.49	.70	.99	1.1	1.6	1.9	2.5	72	80	85	88	
	•	•	•		08	.071	.28	.40	.57	.80	1.1	1.3	1.8	2.2	2.8	72	80	84	87	
	•	•	•		09	.075	.32	.45	.64	.90	1.3	1.4	2.0	2.5	3.2	73	80	84	87	
	•	•		•	10	.079	.35	.50	.71	1.0	1.4	1.6	2.2	2.7	3.5	73	80	84	87	
	•	•		•	11	.083	.39	.55	.78	1.1	1.6	1.7	2.5	3.0	3.9	73	80	83	86	
	•	•		•	12	.087	.42	.60	.85	1.2	1.7	1.9	2.7	3.3	4.2	73	80	83	86	
	•	•		•	13	.090	.46	.65	.92	1.3	1.8	2.1	2.9	3.6	4.6	73	80	83	86	
	•	•		•	14	.093	.49	.70	.99	1.4	2.0	2.2	3.1	3.8	4.9	73	80	83	86	
	•	•		•	15	.097	.53	.75	1.1	1.5	2.1	2.4	3.4	4.1	5.3	74	80	83	86	
	•	•		•	16	.100	.57	.80	1.1	1.6	2.3	2.5	3.6	4.4	5.7	74	80	83	86	
•	•		•	17	.103	.60	.85	1.2	1.7	2.4	2.7	3.8	4.7	6.0	74	80	83	86		
•	•		•	20	.112	.71	1.0	1.4	2.0	2.8	3.2	4.5	5.5	7.1	74	80	83	86		
•	•		•	25	.121	.88	1.3	1.8	2.5	3.5	4.0	5.6	6.8	8.8	74	80	83	86		
•	•		•	30	.133	1.1	1.5	2.1	3.0	4.2	4.7	6.7	8.2	10.6	74	80	83	86		
•	•		•	40	.153	1.4	2.0	2.8	4.0	5.7	6.3	8.9	11.0	14.1	74	80	83	86		
•	•		•	50	.172	1.8	2.5	3.5	5.0	7.1	7.9	11.2	13.7	17.7	74	80	83	85		
•	•		•	60	.188	2.1	3.0	4.2	6.0	8.5	9.5	13.4	16.4	21	75	80	83	85		
•	•		•	70	.203	2.5	3.5	4.9	7.0	9.9	11.1	15.7	19.2	25	75	80	83	86		
73°	•	•	•		0023	.012	–	–	.016	.023	.032	.036	.051	.063	.081	50	73	89	97	
	•	•	•		0039	.016	–	.020	.028	.039	.055	.062	.087	.11	.14	53	73	87	93	
	•	•	•		0077	.023	–	.039	.055	.077	.11	.12	.17	.21	.27	53	73	86	92	
	•	•	•		0116	.028	.041	.058	.082	.12	.16	.18	.26	.32	.41	54	73	85	90	
	•	•	•		0154	.032	.054	.077	.11	.15	.22	.24	.34	.42	.54	55	73	84	88	
	•	•	•		0231	.038	.082	.12	.16	.23	.33	.37	.52	.63	.82	56	73	83	87	
	•	•	•		0308	.044	.11	.15	.22	.31	.44	.49	.69	.84	1.1	58	73	82	86	
	•	•	•		0385	.049	.14	.19	.27	.39	.54	.61	.86	1.1	1.4	59	73	81	85	
	•	•	•		0462	.054	.16	.23	.33	.46	.65	.73	1.0	1.3	1.6	60	73	80	84	
	•	•	•		0616	.062	.22	.31	.44	.62	.87	.97	1.4	1.7	2.2	63	73	79	83	
	•	•	•		0770	.069	.27	.39	.54	.77	1.1	1.2	1.7	2.1	2.7	64	73	77	82	
	•	•	•		0924	.076	.33	.46	.65	.92	1.3	1.5	2.1	2.5	3.3	65	73	77	80	

Other body types may be available. Contact your sales engineer for further information.

Highlighted column shows the rated pressure.



PERFORMANCE DATA

FLAT SPRAY
QUICK-CHANGE NOZZLES: UNIJET® VEEJET®

STANDARD UNITS

PERFORMANCE DATA
STANDARD ANGLE SPRAY TIPS: 13802, TPU, 58102 AND 49803

Spray Angle at 40 psi	UniJet Tip Type				Capacity Size	Equiv. Orifice Dia. (in.)	Flow Rate Capacity (gallons per minute)										Spray Angle (°)			
	13802	TPU	58102	49803			5 psi	10 psi	20 psi	40 psi	80 psi	100 psi	200 psi	300 psi	500 psi	20 psi	40 psi	80 psi	200 psi	
65°	•	•	•		0017	.011	-	-	.012	.017	.024	.027	.038	.047	.06	44	65	77	86	
	•	•	•		0025	.013	-	-	.018	.025	.035	.040	.06	.07	.09	45	65	77	84	
	•	•	•		0033	.015	-	-	.023	.033	.047	.052	.07	.09	.12	47	65	76	83	
	•	•	•		0050	.018	-	-	.035	.050	.07	.08	.11	.14	.18	48	65	75	82	
	•	•	•		0067	.021	-	.033	.05	.067	.09	.11	.15	.18	.24	50	65	75	81	
	•	•	•		01	.026	-	.05	.07	.10	.14	.16	.22	.27	.35	51	65	74	80	
	•	•	•		015	.032	-	.08	.11	.15	.21	.24	.34	.41	.53	51	65	74	80	
	•	•	•		02	.035	.07	.10	.14	.20	.28	.32	.45	.55	.71	52	65	73	79	
	•	•	•		025	.039	.09	.13	.18	.25	.35	.40	.56	.68	.88	52	65	73	79	
	•	•	•		03	.043	.11	.15	.21	.30	.42	.47	.67	.82	1.1	53	65	72	78	
	•	•	•		035	.047	.12	.18	.25	.35	.49	.55	.78	.96	1.2	53	65	72	78	
	•	•	•		04	.050	.14	.20	.28	.40	.57	.63	.89	1.1	1.4	53	65	72	76	
	•	•	•		05	.056	.18	.25	.35	.50	.71	.79	1.1	1.4	1.8	53	65	72	76	
	•	•	•		055	.059	.19	.28	.39	.55	.78	.87	1.2	1.5	1.9	53	65	72	76	
	•	•	•		06	.061	.21	.30	.42	.60	.85	.95	1.3	1.6	2.1	54	65	72	75	
	•	•	•		07	.066	.25	.35	.49	.70	.99	1.1	1.6	1.9	2.5	54	65	72	75	
	•	•	•		08	.071	.28	.40	.57	.80	1.1	1.3	1.8	2.2	2.8	55	65	71	74	
	•	•	•		09	.075	.32	.45	.64	.90	1.3	1.4	2.0	2.5	3.2	55	65	71	74	
	•	•		•	10	.079	.35	.50	.71	1.0	1.4	1.6	2.2	2.7	3.5	56	65	71	74	
	•	•		•	11	.083	.39	.55	.78	1.1	1.6	1.7	2.5	3.0	3.9	56	65	71	74	
	•	•		•	12	.087	.42	.60	.85	1.2	1.7	1.9	2.7	3.3	4.2	56	65	71	74	
•	•		•	13	.090	.46	.65	.92	1.3	1.8	2.1	2.9	3.6	4.6	56	65	71	74		
•	•		•	14	.093	.49	.70	.99	1.4	2.0	2.2	3.1	3.8	4.9	56	65	71	74		
•	•		•	15	.097	.53	.75	1.1	1.5	2.1	2.4	3.4	4.1	5.3	56	65	70	73		
•	•		•	20	.112	.71	1.0	1.4	2.0	2.8	3.2	4.5	5.5	7.1	57	65	70	73		
•	•		•	30	.133	1.1	1.5	2.1	3.0	4.2	4.7	6.7	8.2	10.6	58	65	69	72		
•	•		•	40	.153	1.4	2.0	2.8	4.0	5.7	6.3	8.9	11.0	14.1	59	65	68	72		
•	•		•	50	.172	1.8	2.5	3.5	5.0	7.1	7.9	11.2	13.7	17.7	60	65	68	71		
•	•		•	60	.188	2.1	3.0	4.2	6.0	8.5	9.5	13.4	16.4	21	60	65	68	71		
•	•		•	70	.203	2.5	3.5	4.9	7.0	9.9	11.1	15.7	19.2	25	60	65	68	71		
50°	•	•	•		0017	.011	-	-	.012	.017	.024	.027	.038	.047	.06	44	65	77	86	
	•	•	•		0025	.013	-	-	.018	.025	.035	.040	.06	.07	.09	45	65	77	84	
	•	•	•		0033	.015	-	-	.023	.033	.047	.052	.07	.09	.12	47	65	76	83	
	•	•	•		0050	.018	-	-	.035	.050	.07	.08	.11	.14	.18	48	65	75	82	
	•	•	•		0067	.021	-	.033	.05	.067	.09	.11	.15	.18	.24	50	65	75	81	
	•	•	•		01	.026	-	.05	.07	.10	.14	.16	.22	.27	.35	51	65	74	80	
	•	•	•		015	.032	-	.08	.11	.15	.21	.24	.34	.41	.53	51	65	74	80	
	•	•	•		02	.035	.07	.10	.14	.20	.28	.32	.45	.55	.71	52	65	73	79	
	•	•	•		025	.039	.09	.13	.18	.25	.35	.40	.56	.68	.88	52	65	73	79	
	•	•	•		03	.043	.11	.15	.21	.30	.42	.47	.67	.82	1.1	53	65	72	78	
	•	•	•		035	.047	.12	.18	.25	.35	.49	.55	.78	.96	1.2	53	65	72	78	

Other body types may be available. Contact your sales engineer for further information.

Highlighted column shows the rated pressure.



PERFORMANCE DATA
STANDARD ANGLE SPRAY TIPS: 13802, TPU, 58102 AND 49803

Spray Angle at 40 psi	UniJet Tip Type				Capacity Size	Equiv. Orifice Dia. (in.)	Flow Rate Capacity (gallons per minute)										Spray Angle (°)			
	13802	TPU	58102	49803			5 psi	10 psi	20 psi	40 psi	80 psi	100 psi	200 psi	300 psi	500 psi	20 psi	40 psi	80 psi	200 psi	
50°	•	•	•		04	.050	.14	.20	.28	.40	.57	.63	.89	1.1	1.4	53	65	72	76	
	•	•	•		05	.056	.18	.25	.35	.50	.71	.79	1.1	1.4	1.8	44	50	56	61	
	•	•	•		06	.061	.21	.30	.42	.60	.85	.95	1.3	1.6	2.1	45	50	56	60	
	•	•	•		07	.066	.25	.35	.49	.70	.99	1.1	1.6	1.9	2.5	45	50	56	60	
	•	•	•		075	.068	.27	.38	.53	.75	1.1	1.2	1.7	2.1	2.7	45	50	55	60	
	•	•	•		08	.071	.28	.40	.57	.80	1.1	1.3	1.8	2.2	2.8	45	50	55	60	
	•	•	•		09	.075	.32	.45	.64	.90	1.3	1.4	2.0	2.5	3.2	45	50	55	59	
	•	•		•	10	.079	.35	.50	.71	1.0	1.4	1.6	2.2	2.7	3.5	45	50	55	59	
	•	•		•	13	.090	.46	.65	.92	1.3	1.8	2.1	2.9	3.6	4.6	45	50	55	59	
	•	•		•	15	.097	.53	.75	1.1	1.5	2.1	2.4	3.4	4.1	5.3	45	50	55	59	
	•	•		•	20	.112	.71	1.0	1.4	2.0	2.8	3.2	4.5	5.5	7.1	45	50	55	59	
	•	•		•	30	.133	1.1	1.5	2.1	3.0	4.2	4.7	6.7	8.2	10.6	45	50	55	59	
	•	•		•	40	.153	1.4	2.0	2.8	4.0	5.7	6.3	8.9	11.0	14.1	46	50	54	59	
	•	•		•	50	.172	1.8	2.5	3.5	5.0	7.1	7.9	11.2	13.7	17.7	46	50	54	59	
	•	•		•	60	.188	2.1	3.0	4.2	6.0	8.5	9.5	13.4	16.4	21	46	50	54	59	
•	•		•	70	.203	2.5	3.5	4.9	7.0	9.9	11.1	15.7	19.2	25	46	50	54	59		
40°	•	•	•		0017	.011	-	-	.012	.017	.024	.027	.038	.047	.06	21	40	54	61	
	•	•	•		0025	.013	-	-	.018	.025	.035	.040	.06	.07	.09	22	40	53	60	
	•	•	•		0033	.015	-	-	.023	.033	.047	.052	.07	.09	.12	22	40	53	60	
	•	•	•		0050	.018	-	-	.035	.050	.07	.08	.11	.14	.18	22	40	53	60	
	•	•	•		0067	.021	-	-	.05	.067	.09	.11	.15	.18	.24	24	40	53	60	
	•	•	•		01	.026	-	-	.07	.10	.14	.16	.22	.27	.35	26	40	52	59	
	•	•	•		015	.032	-	-	.11	.15	.21	.24	.34	.41	.53	27	40	52	59	
	•	•	•		02	.035	-	.10	.14	.20	.28	.32	.45	.55	.71	29	40	51	58	
	•	•	•		025	.039	-	.13	.18	.25	.35	.40	.56	.68	.88	29	40	51	58	
	•	•	•		03	.043	-	.15	.21	.30	.42	.47	.67	.82	1.1	30	40	50	57	
	•	•	•		04	.050	-	.20	.28	.40	.57	.63	.89	1.1	1.4	30	40	50	56	
	•	•	•		05	.056	-	.25	.35	.50	.71	.79	1.1	1.4	1.8	31	40	49	55	
	•	•	•		055	.059	-	.28	.39	.55	.78	.87	1.2	1.5	1.9	31	40	49	55	
	•	•	•		06	.061	-	.30	.42	.60	.85	.95	1.3	1.6	2.1	31	40	49	55	
	•	•	•		07	.066	.25	.35	.49	.70	.99	1.1	1.6	1.9	2.5	31	40	49	55	
	•	•	•		08	.071	.28	.40	.57	.80	1.1	1.3	1.8	2.2	2.8	31	40	47	53	
	•	•	•		09	.075	.32	.45	.64	.90	1.3	1.4	2.0	2.5	3.2	32	40	45	48	
	•	•		•	10	.079	.35	.50	.71	1.0	1.4	1.6	2.2	2.7	3.5	32	40	45	48	
	•	•		•	11	.083	.39	.55	.78	1.1	1.6	1.7	2.5	3.0	3.9	32	40	45	48	
	•	•		•	12	.087	.42	.60	.85	1.2	1.7	1.9	2.7	3.3	4.2	32	40	45	48	
	•	•		•	13	.090	.46	.65	.92	1.3	1.8	2.1	2.9	3.6	4.6	32	40	45	48	
	•	•		•	15	.097	.53	.75	1.1	1.5	2.1	2.4	3.4	4.1	5.3	32	40	45	48	
	•	•		•	20	.112	.71	1.0	1.4	2.0	2.8	3.2	4.5	5.5	7.1	32	40	45	48	
	•	•		•	25	.121	.88	1.3	1.8	2.5	3.5	4.0	5.6	6.8	8.8	32	40	45	48	
	•	•		•	30	.133	1.1	1.5	2.1	3.0	4.2	4.7	6.7	8.2	10.6	33	40	45	48	

Other body types may be available. Contact your sales engineer for further information.

Highlighted column shows the rated pressure.



PERFORMANCE DATA

FLAT SPRAY
QUICK-CHANGE NOZZLES: UNIJET®

STANDARD UNITS

PERFORMANCE DATA
STANDARD ANGLE SPRAY TIPS: 13802, TPU, 58102 AND 49803

Spray Angle at 40 psi	UniJet Tip Type				Capacity Size	Equiv. Orifice Dia. (in.)	Flow Rate Capacity (gallons per minute)										Spray Angle (°)			
	13802	TPU	58102	49803			5 psi	10 psi	20 psi	40 psi	80 psi	100 psi	200 psi	300 psi	500 psi	20 psi	40 psi	80 psi	200 psi	
40°	•	•		•	40	.153	1.4	2.0	2.8	4.0	5.7	6.3	8.9	11.0	14.1	34	40	45	48	
	•	•		•	50	.172	1.8	2.5	3.5	5.0	7.1	7.9	11.2	13.7	17.7	35	40	45	48	
	•	•		•	60	.188	2.1	3.0	4.2	6.0	8.5	9.5	13.4	16.4	21	35	40	45	48	
	•	•		•	70	.203	2.5	3.5	4.9	7.0	9.9	11.1	15.7	19.2	25	35	40	45	48	
25°	•	•	•		0017	.011	-	-	-	.017	.024	.027	.038	.047	.06	-	25	35	47	
	•	•	•		0025	.013	-	-	-	.025	.035	.040	.06	.07	.09	-	25	35	45	
	•	•	•		0033	.015	-	-	-	.033	.047	.052	.07	.09	.12	-	25	34	44	
	•	•	•		0050	.018	-	-	-	.050	.07	.08	.11	.14	.18	-	25	34	43	
	•	•	•		0067	.021	-	-	-	.067	.09	.11	.15	.18	.24	-	25	34	42	
	•	•	•		01	.026	-	-	.07	.10	.14	.16	.22	.27	.35	14	25	34	42	
	•	•	•		015	.032	-	-	.11	.15	.21	.24	.34	.41	.53	15	25	34	41	
	•	•	•		02	.035	-	-	.14	.20	.28	.32	.45	.55	.71	15	25	33	40	
	•	•	•		03	.043	-	-	.21	.30	.42	.47	.67	.82	1.1	15	25	33	40	
	•	•	•		04	.050	-	.20	.28	.40	.57	.63	.89	1.1	1.4	16	25	32	39	
	•	•	•		05	.056	-	.25	.35	.50	.71	.79	1.1	1.4	1.8	16	25	32	39	
	•	•	•		055	.059	-	.28	.39	.55	.78	.87	1.2	1.5	1.9	16	25	32	39	
	•	•	•		06	.061	-	.30	.42	.60	.85	.95	1.3	1.6	2.1	17	25	31	38	
	•	•	•		07	.066	-	.35	.49	.70	.99	1.1	1.6	1.9	2.5	17	25	31	38	
	•	•	•		08	.071	-	.40	.57	.80	1.1	1.3	1.8	2.2	2.8	17	25	31	38	
	•	•	•		09	.075	-	.45	.64	.90	1.3	1.4	2.0	2.5	3.2	17	25	31	38	
	•	•		•	10	.079	-	.50	.71	1.0	1.4	1.6	2.2	2.7	3.5	18	25	31	37	
	•	•		•	13	.090	-	.65	.92	1.3	1.8	2.1	2.9	3.6	4.6	18	25	31	37	
	•	•		•	15	.097	-	.75	1.1	1.5	2.1	2.4	3.4	4.1	5.3	18	25	31	37	
	•	•		•	20	.112	-	1.0	1.4	2.0	2.8	3.2	4.5	5.5	7.1	19	25	31	37	
•	•		•	30	.133	1.1	1.5	2.1	3.0	4.2	4.7	6.7	8.2	10.6	20	25	30	36		
•	•		•	40	.153	1.4	2.0	2.8	4.0	5.7	6.3	8.9	11.0	14.1	21	25	29	35		
•	•		•	50	.172	1.8	2.5	3.5	5.0	7.1	7.9	11.2	13.7	17.7	21	25	29	35		
•	•		•	60	.188	2.1	3.0	4.2	6.0	8.5	9.5	13.4	16.4	21	22	25	29	35		
•	•		•	70	.203	2.5	3.5	4.9	7.0	9.9	11.1	15.7	19.2	25	22	25	29	35		
15°	•	•	•		0017	.011	-	-	-	.017	.024	.027	.038	.047	.06	-	15	30	37	
	•	•	•		0025	.013	-	-	-	.025	.035	.040	.06	.07	.09	-	15	28	34	
	•	•	•		0033	.015	-	-	-	.033	.047	.052	.07	.09	.12	-	15	27	32	
	•	•	•		0050	.018	-	-	-	.050	.07	.08	.11	.14	.18	-	15	26	30	
	•	•	•		0067	.021	-	-	-	.067	.09	.11	.15	.18	.24	-	15	25	29	
	•	•	•		01	.026	-	-	-	.10	.14	.16	.22	.27	.35	-	15	24	28	
	•	•	•		015	.032	-	-	-	.15	.21	.24	.34	.41	.53	-	15	23	27	
	•	•	•		02	.035	-	-	.14	.20	.28	.32	.45	.55	.71	6	15	22	27	
	•	•	•		03	.043	-	-	.21	.30	.42	.47	.67	.82	1.1	6	15	22	27	
	•	•	•		04	.050	-	-	.28	.40	.57	.63	.89	1.1	1.4	7	15	21	26	
	•	•	•		05	.056	-	-	.35	.50	.71	.79	1.1	1.4	1.8	7	15	21	26	
	•	•	•		055	.059	-	-	.39	.55	.78	.87	1.2	1.5	1.9	7	15	21	26	

Other body types may be available. Contact your sales engineer for further information.

Highlighted column shows the rated pressure.



PERFORMANCE DATA
STANDARD ANGLE SPRAY TIPS: 13802, TPU, 58102 AND 49803

Spray Angle at 40 psi	UniJet Tip Type				Capacity Size	Equiv. Orifice Dia. (in.)	Flow Rate Capacity (gallons per minute)										Spray Angle (°)			
	13802	TPU	58102	49803			5 psi	10 psi	20 psi	40 psi	80 psi	100 psi	200 psi	300 psi	500 psi	20 psi	40 psi	80 psi	200 psi	
15°	•	•	•		06	.061	-	-	.42	.60	.85	.95	1.3	1.6	2.1	8	15	21	26	
	•	•	•		07	.066	-	-	.49	.70	.99	1.1	1.6	1.9	2.5	8	15	21	26	
	•	•	•		08	.071	-	-	.57	.80	1.1	1.3	1.8	2.2	2.8	9	15	20	25	
	•	•	•		09	.075	-	-	.64	.90	1.3	1.4	2.0	2.5	3.2	9	15	20	25	
	•	•		•	10	.079	-	-	.71	1.0	1.4	1.6	2.2	2.7	3.5	10	15	19	24	
	•	•		•	11	.083	-	.55	.78	1.1	1.6	1.7	2.5	3.0	3.9	10	15	19	24	
	•	•		•	12	.087	.42	.60	.85	1.2	1.7	1.9	2.7	3.3	4.2	10	15	19	24	
	•	•		•	15	.097	.53	.75	1.1	1.5	2.1	2.4	3.4	4.1	5.3	10	15	19	24	
	•	•		•	20	.112	.71	1.0	1.4	2.0	2.8	3.2	4.5	5.5	7.1	10	15	19	23	
	•	•		•	30	.133	1.1	1.5	2.1	3.0	4.2	4.7	6.7	8.2	10.6	10	15	19	21	
	•	•		•	40	.153	1.4	2.0	2.8	4.0	5.7	6.3	8.9	11.0	14.1	10	15	18	21	
	•	•		•	50	.172	1.8	2.5	3.5	5.0	7.1	7.9	11.2	13.7	17.7	11	15	18	21	
	•	•		•	60	.188	2.1	3.0	4.2	6.0	8.5	9.5	13.4	16.4	21	11	15	18	21	
•	•		•	70	.203	2.5	3.5	4.9	7.0	9.9	11.1	15.7	19.2	25	11	15	18	21		
0°	•	•			0009	.008	.003	.004	.005	.009	.013	.014	.020	.025	.032	0 (solid stream)				
	•	•			0012	.010	.004	.006	.008	.012	.017	.019	.027	.033	.042					
	•	•			0019	.012	.007	.009	.013	.019	.027	.030	.043	.052	.067					
	•	•			0021	.013	.007	.010	.011	.023	.033	.040	.047	.052	.074					
	•	•			0033	.016	.01	.02	.023	.033	.047	.052	.07	.09	.12					
	•	•			0050	.019	.018	.025	.035	.050	.07	.08	.11	.14	.18					
	•	•			0067	.023	.024	.033	.05	.067	.09	.11	.15	.18	.24					
	•	•			01	.028	.035	.05	.07	.10	.14	.16	.22	.27	.35					
	•	•			015	.034	.05	.08	.11	.15	.21	.24	.34	.41	.53					
	•	•			02	.039	.07	.10	.14	.20	.28	.32	.45	.55	.71					
	•	•			03	.041	.11	.15	.21	.30	.42	.47	.67	.82	1.1					
	•	•			04	.047	.14	.20	.28	.40	.57	.63	.89	1.1	1.4					
	•	•			045	.052	.16	.23	.32	.45	.64	.71	1.0	1.2	1.6					
	•	•			05	.053	.18	.25	.35	.50	.71	.79	1.1	1.4	1.8					
	•	•			055	.055	.19	.28	.39	.55	.78	.87	1.2	1.5	1.9					
	•	•			06	.058	.21	.30	.42	.60	.85	.95	1.3	1.6	2.1					
	•	•			065	.060	.23	.33	.46	.65	.92	1.0	1.5	1.8	2.3					
	•	•			07	.062	.25	.35	.49	.70	.99	1.1	1.6	1.9	2.5					
	•	•			08	.067	.28	.40	.57	.80	1.1	1.3	1.8	2.2	2.8					
	•	•			09	.071	.32	.45	.64	.90	1.3	1.4	2.0	2.5	3.2					
	•	•			10	.075	.35	.50	.71	1.0	1.4	1.6	2.2	2.7	3.5					
	•	•			11	.079	.39	.55	.78	1.1	1.6	1.7	2.5	3.0	3.9					
	•	•			12	.082	.42	.60	.85	1.2	1.7	1.9	2.7	3.3	4.2					
	•	•			15	.091	.53	.75	1.1	1.5	2.1	2.4	3.4	4.1	5.3					
•	•			20	.106	.71	1.0	1.4	2.0	2.8	3.2	4.5	5.5	7.1						
•	•			30	.129	1.1	1.5	2.1	3.0	4.2	4.7	6.7	8.2	10.6						
•	•			40	.149	1.4	2.0	2.8	4.0	5.7	6.3	8.9	11.0	14.1						

Other body types may be available. Contact your sales engineer for further information.

Highlighted column shows the rated pressure.



PERFORMANCE DATA

FLAT SPRAY
QUICK-CHANGE NOZZLES: UNIJET®

STANDARD UNITS

ASSEMBLY DIMENSIONS AND WEIGHTS:

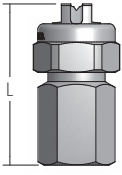
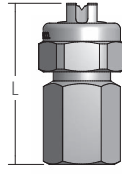
Nozzle	Tip/Body Type	Conn. Thread Size (in.)	L (in.)	Hex. (in.)	Net Weight (oz.)
	TPU + T (F) TPU + TT (M)	1/8, 1/4, 3/8, 1/2	1.610	13/16	2.3
	13802 + T (F) 13802 TT (M) +	1/8, 1/4, 3/8, 1/2	1.891	13/16	2.3

Based on the largest/heaviest version of each type.

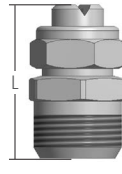
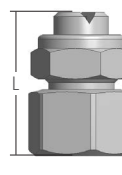
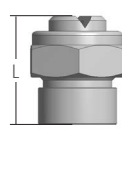
Nozzle	Tip/Body Type	Conn. Size/Type (in.)	L (in.)	Hex. (in.)	Net Weight (oz.)
	49803/58102 + 50868	1/4	1.48	3/4	2.3
	49803/58102 + 50869	1/4	1.47	3/4	2.1
	49803/58102 + 49801	Butt Weld	1.28	-	2.2

SPRAY TIP DIMENSIONS:

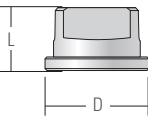
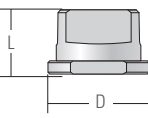
Spray Tip	Spray Tip Type	L (in.)	D (Dia.) (in.)	Wrench Flats (in.)	Dovetail Flats (in.)
	TPU	0.375	0.594	0.312	-
	13802	0.375	0.593	0.312	0.495

Based on the largest/heaviest version of each type.

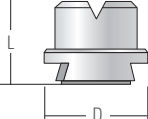
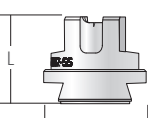
Spray Tip	Spray Tip Type	L (in.)	D (Dia.) (in.)	Wrench Flats (in.)	Dovetail Flats (in.)
	49803	.464	.578	-	0.410
	58102	0.490	0.580	0.312	0.410

Based on the largest/heaviest version of each type.

Dovetail spray tips can be used on a variety of body types.

**PERFORMANCE DATA
STANDARD ANGLE SPRAY TIPS: 45824**

Nozzle Type/ Conn. Size (in.)		Orifice Dia. Nom. (in.)	Capacity Size	Flow Rate Capacity (gallons per minute)*
45824				10 psi
1-1/4	1-1/2			
●	●	0.750	750	60
●	●	0.875	875	80
●	●	1.000	1000	100
●	●	1.125	1125	130
●	●	1.250	1250	150

*Reference flow rates measured at 10 psi using water. Field studies indicate black liquor flow rates are approximately 50% of water flow rates. Spray angle 130°
Highlighted column shows the rated pressure.

**PERFORMANCE DATA
STANDARD ANGLE SPRAY: U**

Spray Angle at 40 psi	Nozzle Type/ Conn. Size (in.)	Capacity Size	Equiv. Orifice Dia. (in.)	Flow Rate Capacity (gallons per minute)									Spray Angle (°)			
	U			5 psi	10 psi	20 psi	40 psi	80 psi	100 psi	200 psi	300 psi	500 psi	20 psi	40 psi	80 psi	200 psi
	1-1/4															
65°	●	500	.528	17.7	25	35	50	71	79	112	137	177	60	65	66	68
	●	500	.528	17.7	25	35	50	71	79	112	137	177	49	50	51	54
50°	●	750	.647	27	38	53	75	106	119	168	205	265	49	50	51	53
	●	1000	.747	35	50	71	100	141	158	224	274	354	49	50	51	53
25°	●	500	.528	17.7	25	35	50	71	79	112	137	177	24	25	26	29
	●	750	.647	27	38	53	75	106	119	168	205	265	24	25	26	28
	●	1000	.747	35	50	71	100	141	158	224	274	354	24	25	26	28
15°	●	500	.528	17.7	25	35	50	71	79	112	137	177	14	15	16	17
	●	1000	.747	35	50	71	100	141	158	224	274	354	14	15	16	17

Highlighted column shows the rated pressure.

DIMENSIONS AND WEIGHTS

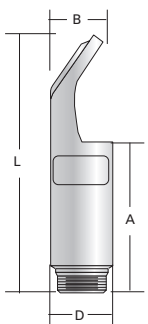
Nozzle	Nozzle Type	Conn. Size (in.)	L (in.)	A (in.)	B (in.)	D (Dia.) (in.)	Net Weight (oz.)
	45824	1-1/4	8.28	4.84	1.39	2.00	75.2

Based on the largest/heaviest version of each type.

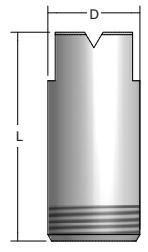
Nozzle	Nozzle Type	Conn. Size (in.)	L (in.)	D (Dia.) (in.)	Net Weight (oz.)
	U	1-1/4	3.75	1.69	20

Based on the largest/heaviest version of each type.

PERFORMANCE DATA

FLAT SPRAY

QUICK-CHANGE NOZZLES: QUICKJET® AND UNIJET®

STANDARD UNITS

PERFORMANCE DATA
WIDE ANGLE SPRAY: QSTK, QTKA

Inlet Conn. (in.)	Quick FloodJet Tip Type		Capacity Size	Equiv. Orifice Dia. (in.)	Flow Rate Capacity (gallons per minute)							Spray Angle (°)		
	QSTK	QTKA			3 psi	7 psi	10 psi	20 psi	30 psi	40 psi	60 psi	7 psi	20 psi	60 psi
1/8, 1/4, 3/8, 1/2	●		.25	.017	–	–	–	.04	.04	.05	.06	–	83	117
	●	●	.50	.023	–	–	–	.07	.09	.10	.12	–	89	122
	●	●	.75	.029	–	–	.075	.11	.13	.15	.18	–	106	125
	●	●	1	.033	–	–	.10	.14	.17	.20	.24	–	109	128
	●	●	1.5	.040	–	.13	.15	.21	.26	.30	.37	73	108	125
	●	●	2	.047	–	.17	.20	.28	.35	.40	.49	83	113	129
	●	●	2.5	.052	–	.21	.25	.35	.43	.50	.61	98	122	133
	●	●	3	.057	–	.25	.30	.42	.52	.60	.73	86	112	126
	●	●	4	.066	–	.33	.40	.57	.69	.80	.98	97	123	132
	●	●	5	.074	.27	.42	.50	.71	.87	1.0	1.2	114	128	142
		●	7.5	.091	.41	.63	.75	1.1	1.3	1.5	1.8	101	119	134
		●	10	.105	.55	.84	1.0	1.4	1.7	2.0	2.4	115	133	145
		●	12	.115	.66	1.0	1.2	1.7	2.1	2.4	2.9	128	139	153
		●	15	.128	.82	1.3	1.5	2.1	2.6	3.0	3.7	98	113	123
		●	18	.140	.99	1.5	1.8	2.5	3.1	3.6	4.4	106	120	131
	●	20	.148	1.1	1.7	2.0	2.8	3.5	4.0	4.9	110	122	133	
3/8, 1/2		●	30	.181	1.6	2.5	3.0	4.2	5.2	6.0	7.3	100	110	121
		●	40	.209	2.2	3.3	4.0	5.7	6.9	8.0	9.8	111	126	136
		●	45	.222	2.5	3.8	4.5	6.4	7.8	9.0	11.0	115	130	140
		●	60	.256	3.3	5.0	6.0	8.5	10.4	12.0	14.7	120	134	142

Highlighted column shows the rated pressure.

PERFORMANCE DATA
WIDE ANGLE SPRAY: TK

Inlet Conn. (in.)	UniJet® FloodJet Tip Type	Capacity Size	Equiv. Orifice Dia. (in.)	Flow Rate Capacity (gallons per minute)							Spray Angle (°)		
	TK			3 psi	7 psi	10 psi	20 psi	30 psi	40 psi	60 psi	7 psi	20 psi	60 psi
1/4	●	.50	.023	–	–	–	.07	.09	.10	.12	–	89	122
	●	.75	.029	–	–	.075	.11	.13	.15	.18	–	106	125
	●	1	.033	–	–	.10	.14	.17	.20	.24	–	109	128
	●	1.5	.040	–	.13	.15	.21	.26	.30	.37	73	108	125
	●	2	.047	–	.17	.20	.28	.35	.40	.49	83	113	129
	●	2.5	.052	–	.21	.25	.35	.43	.50	.61	98	122	133
	●	3	.057	–	.25	.30	.42	.52	.60	.73	86	112	126
	●	4	.066	–	.33	.40	.57	.69	.80	.98	97	123	132
	●	5	.074	.27	.42	.50	.71	.87	1.0	1.2	114	128	142

Other body types may be available. Contact your sales engineer for further information.

Highlighted column shows the rated pressure.



FLAT SPRAY
QUICK-CHANGE NOZZLES: QUICKJET® AND UNIJET®

PERFORMANCE
DATA

STANDARD UNITS

PERFORMANCE DATA
WIDE ANGLE SPRAY: TK

Conn. Size (in.)	UniJet® FloodJet Tip Type	Capacity Size	Equiv. Orifice Dia. (in.)	Flow Rate Capacity (gallons per minute)							Spray Angle (°)		
	TK			3 psi	7 psi	10 psi	20 psi	30 psi	40 psi	60 psi	7 psi	20 psi	60 psi
1/4	●	7.5	.091	.41	.63	.75	1.1	1.3	1.5	1.8	101	119	134
	●	10	.105	.55	.84	1.0	1.4	1.7	2.0	2.4	115	133	145
	●	12	.115	.66	1.0	1.2	1.7	2.1	2.4	2.9	128	139	153
	●	15	.128	.82	1.3	1.5	2.1	2.6	3.0	3.7	98	113	123
	●	18	.140	.99	1.5	1.8	2.5	3.1	3.6	4.4	106	120	131
	●	20	.148	1.1	1.7	2.0	2.8	3.5	4.0	4.9	110	122	133
	●	24	.162	1.3	2.0	2.4	3.4	4.2	4.8	5.9	115	131	144
	●	30	.181	1.6	2.5	3.0	4.2	5.2	6.0	7.3	100	110	121
	●	40	.209	2.2	3.3	4.0	5.7	6.9	8.0	9.8	111	126	136
	●	50	.234	2.7	4.2	5.0	7.1	8.7	10.0	12.2	117	131	140

Other body types may be available. Contact your sales engineer for further information.

Highlighted column shows the rated pressure.

DIMENSIONS AND WEIGHTS

Nozzle	Nozzle Type	Conn. Size/Type (in.)	L (in.)	Hex. (in.)	D (Dia.) (in.)	Net Weight (oz.)
	QJA + QTKA	1/8, 1/4, 3/8, 1/2 female	2.531	1	-	5
	QJJA + QTKA	1/8, 1/4, 3/8, 1/2 male	2.438	7/8	-	4.5

Based on the largest/heaviest version of each type.

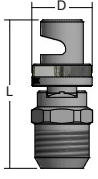
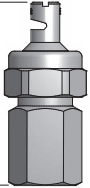
Nozzle	Nozzle Type	Conn. Size/Type (in.)	L (in.)	Hex. (in.)	D (Dia.) (in.)	Net Weight (oz.)
	QJJS + QSTK	1/8, 1/4, 3/8, 1/2 male	1.469	9/16	0.594	1.5
	T + TK	1/4 female	2.000	13/16	-	2.5
	TT + TK	1/4 male	2.000	13/16	-	2.3

Based on the largest/heaviest version of each type.

PLACING YOUR ORDER

Call your local spray expert for application assistance or to place an order.

PERFORMANCE DATA
WIDE ANGLE SPRAY: K, 11499, 13063

Nozzle Type			Conn. Size (in.)						Capacity Size	Equiv. Orifice Dia. (in.)	Flow Rate Capacity (gallons per minute)						Spray Angle (°)			
K	11499	13063	1/8	1/4	3/8	1/2	3/4	1			3 psi	7 psi	10 psi	20 psi	30 psi	40 psi	60 psi	7 psi	20 psi	60 psi
•			•						.25	.017	–	–	–	.04	.04	.05	.06	–	83	117
•			•						.50	.023	–	–	–	.07	.09	.10	.12	–	89	122
•			•						.75	.029	–	–	.075	.11	.13	.15	.18	–	106	125
•			•						1	.033	–	–	.10	.14	.17	.20	.24	–	103	128
•			•						1.5	.040	–	.13	.15	.21	.26	.30	.37	73	103	125
•	•		•	•					2	.047	–	.17	.20	.28	.35	.40	.49	83	113	129
•	•		•	•					2.5	.052	–	.21	.25	.35	.43	.50	.61	98	122	133
•	•		•	•					3	.057	–	.25	.30	.42	.52	.60	.73	86	112	126
•	•	•	•						4	.066	–	.33	.40	.57	.69	.80	.98	97	123	132
•	•	•	•	•					5	.074	.27	.42	.50	.71	.87	1.0	1.2	114	128	142
•	•	•	•	•					7.5	.091	.41	.63	.75	1.1	1.3	1.5	1.8	101	119	134
•	•	•	•	•					10	.105	.55	.84	1.0	1.4	1.7	2.0	2.4	115	133	145
•			•	•					12	.115	.66	1.0	1.2	1.7	2.1	2.4	2.9	128	139	153
•	•		•	•					15	.128	.82	1.3	1.5	2.1	2.6	3.0	3.7	98	113	123
•	•		•	•					18	.140	.99	1.5	1.8	2.5	3.1	3.6	4.4	106	120	131
•			•	•					20	.148	1.1	1.7	2.0	2.8	3.5	4.0	4.9	110	122	133
•			•						22	.155	1.2	1.8	2.2	3.1	3.8	4.4	5.4	113	125	136
•			•						24	.162	1.3	2.0	2.4	3.4	4.2	4.8	5.9	115	131	144
•			•						27	.172	1.5	2.3	2.7	3.8	4.7	5.4	6.6	119	135	148
•				•					30	.181	1.6	2.5	3.0	4.2	5.2	6.0	7.3	100	110	121
•				•					35	.196	1.9	2.9	3.5	4.9	6.1	7.0	8.6	105	118	128
•				•	•				40	.209	2.2	3.3	4.0	5.7	6.9	8.0	9.8	111	126	136
•				•					45	.222	2.5	3.8	4.5	6.4	7.8	9.0	11.0	115	130	140
•					•				50	.234	2.7	4.2	5.0	7.1	8.7	10.0	12.2	117	131	140
•					•				60	.256	3.3	5.0	6.0	8.5	10.4	12.0	14.7	120	134	142
•					•				70	.277	3.8	5.9	7.0	9.9	12.1	14.0	17.1	123	137	146
•					•				80	.296	4.4	6.7	8.0	11.3	13.9	16.0	19.6	127	138	149
•						•			90	.317	4.9	7.5	9.0	12.7	15.6	18.0	22	120	133	140
•						•			100	.334	5.5	8.4	10.0	14.1	17.3	20	24	123	136	145
•						•			110	.350	6.0	9.2	11.0	15.6	19.1	22	27	125	138	148
•						•			120	.366	6.6	10.0	12.0	17.0	21	24	29	129	143	150
•						•			140	.395	7.7	11.7	14.0	19.8	24	28	34	118	127	135
•						•			160	.423	8.8	13.4	16.0	23	28	32	39	121	130	137
•						•			180	.448	9.9	15.1	18.0	25	31	36	44	124	133	139
•						•			210	.484	11.5	17.6	21	30	36	42	51	128	139	145
•							•		300	.579	16.4	25	30	42	52	60	73	110	128	135
•							•		450	.709	25	38	45	64	78	90	110	118	132	138

Highlighted column shows the rated pressure.

DIMENSIONS AND WEIGHTS

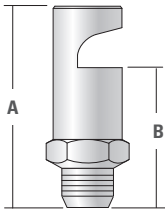

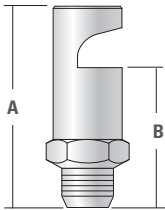
Nozzle	Nozzle Type	Conn. Size/Type (in.)	A (in.)	B (in.)	Hex. (in.)	Net Weight (oz.)
	K	1/8 male	1.281	0.734	7/16	0.5
		1/4 male	1.343	0.859	9/16	1
		3/8 male	1.750	1	11/16	2
		1/2 male	2.000	1.188	7/8	4
		3/4 male	2.563	1.563	1-1/2	14
		1 male	3.625	2.188	1-7/8	32
	11499	1/8 male	1.594	1.11	9/16	0.5
	13063	1/8 male	1.594	1.25	7/16	0.5

Based on the largest/heaviest version of each type.

PLACING YOUR ORDER

Call your local spray expert for application assistance or to place an order.

PERFORMANCE DATA

FLAT SPRAY
FLATJET® NOZZLES

STANDARD UNITS

PERFORMANCE DATA
NARROW ANGLE SPRAY: P

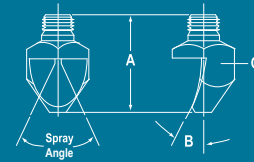

Spray Angle at 40 psi	Nozzle Type P	Conn. Size (in.)					Capacity Size	Equiv. Orifice Dia. (in.)	Flow Rate Capacity (gallons per minute)							Spray Angle (°)			Dimensions			
		1/8	1/4	3/8	1/2	3/4			15 psi	20 psi	40 psi	80 psi	100 psi	150 psi	15 psi	40 psi	100 psi	A Length (in.)	B Deflection Angle (°)	C Bar Size (in. sq.)	Net Weight (oz.)	
50°	•		•				05	.052	.31	.35	.50	.71	.79	.97	33	50	60	1-7/32	60	5/8	1	
	•		•				10	.074	.61	.71	1.0	1.4	1.6	1.9	34	50	60	1-7/32	60	5/8	1	
	•		•	•			25	.117	1.5	1.8	2.5	3.5	4.0	4.8	42	50	59	1-5/8	42	3/4	3	
	•		•	•			40	.148	2.4	2.8	4.0	5.7	6.3	7.7	39	50	60	1-27/32	45	3/4	3	
	•			•			60	.181	3.7	4.2	6.0	8.5	9.5	11.6	42	50	53	2-5/32	37	1	5	
	•			•			100	.234	6.1	7.1	10.0	14.1	15.8	19.4	43	50	55	2-27/32	40	1-1/4	11.5	
	•			•			125	.261	7.7	8.8	12.5	17.7	19.8	24	38	50	59	2-27/32	38	1-1/4	11	
	•			•			160	.296	9.8	11.3	16.0	23	25	31	44	50	55	2-27/32	37	1-1/4	11	
	•			•			200	.331	12.2	14.1	20	28	32	39	46	50	53	2-27/32	32	1-1/4	11	
40°	•			•			40	.148	2.4	2.8	4.0	5.7	6.3	7.7	31	40	50	2-3/8	35	7/8	5	
	•			•			50	.165	3.1	3.5	5.0	7.1	7.9	9.7	31	40	49	2-1/2	33	1	7	
	•			•			60	.181	3.7	4.2	6.0	8.5	9.5	11.6	32	40	49	2-27/32	33	1	8	
	•			•			70	.196	4.3	4.9	7.0	9.9	11.1	13.6	32	40	49	2-31/32	29	1	9	
	•			•			80	.209	4.9	5.7	8.0	11.3	12.6	15.5	32	40	48	3-1/32	26	1	9	
	•			•			90	.222	5.5	6.4	9.0	12.7	14.2	17.4	34	40	44	3-1/32	28	1	8	
	•			•			100	.234	6.1	7.1	10.0	14.1	15.8	19.4	35	40	44	3-13/32	28	1	9	
35°	•	•					04	.047	.24	.28	.40	.57	.63	.77	20	35	41	29/32	40	7/16	5	
	•		•				10	.074	.61	.71	1.0	1.4	1.6	1.9	18	35	39	1-7/16	36	5/8	2	
	•		•	•			20	.105	1.2	1.4	2.0	2.8	3.2	3.9	24	35	40	1-21/32	30	3/4	2	
	•			•			25	.117	1.5	1.8	2.5	3.5	4.0	4.8	24	35	39	1-15/16	28	3/4	3	
	•			•			30	.128	1.8	2.1	3.0	4.2	4.7	5.8	26	35	41	2-1/16	28	3/4	3	
	•			•			40	.148	2.4	2.8	4.0	5.7	6.3	7.7	28	35	38	2-9/32	26	7/8	4	
	•			•			50	.165	3.1	3.5	5.0	7.1	7.9	9.7	31	35	38	2-1/2	23	7/8	5	
	•				•		60	.181	3.7	4.2	6.0	8.5	9.5	11.6	29	35	39	2-7/8	27	1	8	
	•				•		80	.209	4.9	5.7	8.0	11.3	12.6	15.5	26	35	40	3-3/16	24	1	9	
	•				•		100	.234	6.1	7.1	10.0	14.1	15.8	19.4	26	35	40	3-1/2	19	1	9	
	•					•	160	.296	9.8	11.3	16.0	23	25	31	26	35	40	4-1/2	23	1-1/4	20	
	•					•	200	.331	12.2	14.1	20	28	32	39	25	35	40	4-13/16	22	1-1/4	20	

Highlighted column shows the rated pressure.



**PERFORMANCE DATA
NARROW ANGLE SPRAY: P**

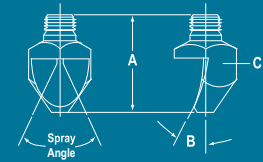

Spray Angle at 40 psi	Nozzle Type	Conn. Size (in.)					Capacity Size	Equiv. Orifice Dia. (in.)	Flow Rate Capacity (gallons per minute)						Spray Angle (°)			Dimensions			
		1/8	1/4	3/8	1/2	3/4			15 psi	20 psi	40 psi	80 psi	100 psi	150 psi	15 psi	40 psi	100 psi	A Length (in.)	B Deflection Angle (°)	C Bar Size (in. sq.)	Net Weight (oz.)
25°	●		●				40	.148	2.4	2.8	4.0	5.7	6.3	7.7	15	25	34	2-9/16	25	3/4	4
	●		●				10	.074	-	.71	1.0	1.4	1.6	1.9	-	15	23	1-7/8	22	5/8	2
15°	●		●				20	.105	-	1.4	2.0	2.8	3.2	3.9	-	15	19	2-1/8	19	5/8	2
	●			●			30	.128	1.8	2.1	3.0	4.2	4.7	5.8	6	15	24	2-27/32	25	3/4	4
	●			●			40	.148	2.4	2.8	4.0	5.7	6.3	7.7	8	15	21	3-5/8	18	7/8	8
	●			●			50	.165	3.1	3.5	5.0	7.1	7.9	9.7	9	15	20	3-9/16	15	7/8	6
	●				●		60	.181	3.7	4.2	6.0	8.5	9.5	11.6	10	15	19	4-15/16	14	1	12
	●				●		80	.209	4.9	5.7	8.0	11.3	12.6	15.5	11	15	18	5-1/8	14	1	12
	●				●		100	.234	6.1	7.1	10.0	14.1	15.8	19.4	11	15	18	5-5/32	14	1	14
	●					●	200	.331	12.2	14.1	20	28	32	39	12	15	18	6-1/2	14	1-1/4	26

Highlighted column shows the rated pressure.

**PERFORMANCE DATA
NARROW ANGLE SPRAY: 115220**

Spray Angle at 40 psi	Nozzle Type	Conn. Size (in.)	Capacity Size	Equiv. Orifice Dia. (in.)	Flow Rate Capacity (gallons per minute)						Spray Angle (°)			Dimensions		
					15 psi	20 psi	40 psi	80 psi	100 psi	150 psi	15 psi	40 psi	100 psi	A Length (in.)	B Deflection Angle (°)	C Bar Size (in. sq.)
50°	●	●	20	.105	1.2	1.4	2.0	2.8	3.2	3.9	42	50	59	2-7/16	45	7/8
	●	●	30	.128	1.8	2.1	3.0	4.2	4.7	5.8	42	50	59	2-7/16	45	7/8
	●	●	40	.148	2.4	2.8	4.0	5.7	6.3	7.7	39	50	60	2-7/16	45	7/8
35°	●	●	20	.105	1.2	1.4	2.0	2.8	3.2	3.9	24	35	40	2-7/8	28	7/8
	●	●	30	.128	1.8	2.1	3.0	4.2	4.7	5.8	26	35	41	2-7/8	28	7/8
	●	●	40	.148	2.4	2.8	4.0	5.7	6.3	7.7	28	35	38	2-7/8	28	7/8

Highlighted column shows the rated pressure.



PERFORMANCE DATA

FLAT SPRAY
QUICK-CHANGE NOZZLES: QUICKJET®

STANDARD UNITS

PERFORMANCE DATA
NARROW ANGLE SPRAY: QLPA

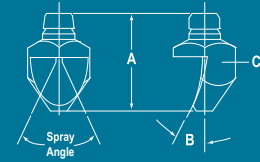

Spray Angle at 40 psi	Nozzle Type	Conn. Size (in.)		Capacity Size	Equiv. Orifice Dia. (in.)	Capacity (gallons per minute)								Spray Angle (°)			Dimensions			
		3/8	1/2			15 psi	20 psi	30 psi	40 psi	60 psi	80 psi	100 psi	150 psi	15 psi	40 psi	100 psi	A Length (in.)	B Deflection Angle (°)	C Bar Size (in. sq.)	Net Weight (oz.)
50°	●	●	●	60	.181	3.7	4.2	5.2	6.0	7.3	8.5	9.5	11.6	42	50	53	3-3/16	37	1	8
				125	.261	7.7	8.8	10.8	12.5	15.3	17.7	19.8	24	38	50	59	3-7/8	38	1-1/4	8-1/2
35°	●	●	●	60	.181	3.7	4.2	5.2	6.0	7.3	8.5	9.5	11.6	29	35	39	3-7/8	27	1	8
				80	.209	4.9	5.7	6.9	8.0	9.8	11.3	12.6	15.5	26	35	40	4-3/16	24	1-1/4	8-1/2

Highlighted column shows the rated pressure.

DIMENSIONS

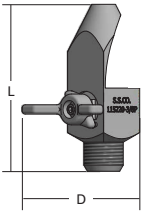
Nozzle	Nozzle Type	Conn. Size/Type (in.)	L (in.)	D (Dia.) (in.)
	115220	3/8 male	2.86	2.01

Based on the largest/heaviest version of each type.

PLACING YOUR ORDER

Call your local spray expert for application assistance or to place an order.

PERFORMANCE DATA
STANDARD ANGLE SPRAY: AX, BX

Conn. Size (in.)	Nozzle Type		Capacity Size	Inlet Dia. Nom. (in.)	Orifice Dia. Nom. (in.)	Flow Rate Capacity (gallons per minute)										Spray Angle (°)		
	AX	BX				3 psi	5 psi	10 psi	15 psi	20 psi	30 psi	40 psi	60 psi	80 psi	100 psi	10 psi	20 psi	80 psi
1/8	●	●	.5	.031	.047	–	–	.05	.06	.07	.09	.10	.12	.14	.16	39	58	69
	●	●	1	.063	.063	–	–	.10	.12	.14	.17	.20	.24	.28	.32	41	64	76
	●	●	2	.078	.078	–	.14	.20	.24	.28	.35	.40	.49	.57	.63	52	61	69
	●	●	3	.094	.094	–	.21	.30	.37	.42	.52	.60	.73	.85	.95	52	64	77
	●	●	5	.125	.125	.27	.35	.50	.61	.71	.87	1.0	1.2	1.4	1.6	56	67	76
	●	●	8	.156	.156	.44	.57	.80	.98	1.1	1.4	1.6	2.0	2.3	2.5	56	65	70
	●	●	10	.172	.172	.55	.71	1.0	1.2	1.4	1.7	2.0	2.4	2.8	3.2	55	65	72
1/4	●	●	1	.063	.063	–	–	.10	.12	.14	.17	.20	.24	.28	.32	47	53	67
	●	●	2	.078	.078	–	–	.20	.24	.28	.35	.40	.49	.57	.63	56	62	71
	●	●	3	.094	.094	–	.21	.30	.37	.42	.52	.60	.73	.85	.95	51	65	78
	●	●	5	.141	.141	.27	.35	.50	.61	.71	.87	1.0	1.2	1.4	1.6	63	73	79
	●	●	8	.156	.156	.44	.57	.80	.98	1.1	1.4	1.6	2.0	2.3	2.5	61	69	73
	●	●	10	.188	.172	.55	.71	1.0	1.2	1.4	1.7	2.0	2.4	2.8	3.2	63	70	74
	●	●	15	.234	.203	.82	1.1	1.5	1.8	2.1	2.6	3.0	3.7	4.2	4.7	63	71	72
3/8	●	●	5	.140	.125	.27	.35	.50	.61	.71	.87	1.0	1.2	1.4	1.6	64	73	79
	●	●	8	.172	.156	.44	.57	.80	.98	1.1	1.4	1.6	2.0	2.3	2.5	62	70	74
	●	●	10	.203	.172	.55	.71	1.0	1.2	1.4	1.7	2.0	2.4	2.8	3.2	64	72	75
	●	●	15	.234	.219	.82	1.1	1.5	1.8	2.1	2.6	3.0	3.7	4.2	4.7	64	72	74
	●	●	20	.281	.250	1.1	1.4	2.0	2.4	2.8	3.5	4.0	4.9	5.7	6.3	63	70	74
	●	●	25	.297	.297	1.4	1.8	2.5	3.1	3.5	4.3	5.0	6.1	7.1	7.9	63	70	74
	●	●	30	.328	.313	1.6	2.1	3.0	3.7	4.2	5.2	6.0	7.3	8.5	9.5	63	70	74
1/2	●	●	25	.375	.250	1.4	1.8	2.5	3.1	3.5	4.3	5.0	6.1	7.1	7.9	63	66	71
	●	●	30	.375	.297	1.6	2.1	3.0	3.7	4.2	5.2	6.0	7.3	8.5	9.5	67	71	75
	●	●	40	.375	.359	2.2	2.8	4.0	4.9	5.7	6.9	8.0	9.8	11.3	12.6	72	76	78
	●	●	50	.375	.438	2.7	3.5	5.0	6.1	7.1	8.7	10.0	12.2	14.1	15.8	74	79	82
	●	●	60	.375	.516	3.3	4.2	6.0	7.3	8.5	10.4	12.0	14.7	17.0	19.0	77	82	86
3/4	●	●	40	.500	.297	2.2	2.8	4.0	4.9	5.7	6.9	8.0	9.8	11.3	12.6	70	73	74
	●	●	50	.500	.344	2.7	3.5	5.0	6.1	7.1	8.7	10.0	12.2	14.1	15.8	72	75	77
	●	●	60	.500	.406	3.3	4.2	6.0	7.3	8.5	10.4	12.0	14.7	17.0	19.0	74	76	79
	●	●	70	.500	.469	3.8	4.9	7.0	8.6	9.9	12.1	14.0	17.1	19.8	22	76	79	83
	●	●	80	.500	.531	4.4	5.7	8.0	9.8	11.3	13.9	16.0	19.6	23	25	78	82	84
	●	●	90	.500	.578	4.9	6.4	9.0	11.0	12.7	15.6	18.0	22	25	28	81	84	84
	●	●	100	.500	.625	5.5	7.1	10.0	12.2	14.1	17.3	20	24	28	32	83	86	86
	●	●	110	.500	.672	6.0	7.8	11.0	13.5	15.6	19.1	22	27	31	35	85	88	88
●	●	120	.500	.719	6.6	8.5	12.0	14.7	17.0	21	24	29	34	38	87	90	90	

Intermediate capacities: Caps are interchangeable for in-between capacities within each pipe size group. Request Data Sheets 3055, 3986 and 3987.
Spray dimension data: Request Data Sheets 15350 and 15362.

Highlighted column shows the rated pressure.

PERFORMANCE DATA

HOLLOW CONE
WHIRLJET® NOZZLES

STANDARD UNITS

PERFORMANCE DATA
STANDARD ANGLE SPRAY: CX

Conn. Size (in.)	Nozzle Type CX	Capacity Size	Inlet Dia. Nom. (in.)	Orifice Dia. Nom. (in.)	Flow Rate Capacity (gallons per minute)												Spray Angle (°)		
					3 psi	4 psi	5 psi	7 psi	10 psi	15 psi	20 psi	30 psi	40 psi	60 psi	80 psi	100 psi	7 psi	20 psi	60 psi
1	●	7	.688	.453	4.6	5.3	5.9	7.0	8.4	10.2	11.8	14.5	16.7	20	24	26	64	65	66
	●	8	.688	.500	5.2	6.0	6.8	8.0	9.6	11.7	13.5	16.6	19.1	23	27	30	65	66	67
	●	9	.688	.563	5.9	6.8	7.6	9.0	10.8	13.2	15.2	18.6	22	26	30	34	66	67	69
	●	10	.688	.609	6.5	7.6	8.5	10.0	12.0	14.6	16.9	21	24	29	34	38	67	69	71
	●	12	.688	.672	7.9	9.1	10.1	12.0	14.3	17.6	20	25	29	35	41	45	70	73	75
	●	15	.688	.813	9.8	11.3	12.7	15.0	17.9	22	25	31	36	44	51	57	76	79	81
1-1/4	●	10	.844	.563	6.5	7.6	8.5	10.0	12.0	14.6	16.9	21	24	29	34	38	65	67	67
	●	12	.844	.641	7.9	9.1	10.1	12.0	14.3	17.6	20	25	29	35	41	45	68	70	71
	●	14	.844	.719	9.2	10.6	11.8	14.0	16.7	20	24	29	33	41	47	53	71	73	75
	●	16	.844	.797	10.5	12.1	13.5	16.0	19.1	23	27	33	38	47	54	60	74	75	77
	●	20	.844	.953	13.1	15.1	16.9	20	24	29	34	41	48	59	68	76	76	77	79
1-1/2	●	16	1.094	.688	10.5	12.1	13.5	16.0	19.1	23	27	33	38	47	54	60	64	67	69
	●	20	1.094	.859	13.1	15.1	16.9	20	24	29	34	41	48	59	68	76	69	72	74
	●	25	1.094	1.016	16.4	18.9	21	25	30	37	42	52	60	73	85	94	72	74	76
	●	30	1.094	1.125	19.6	23	25	30	36	44	51	62	72	88	101	113	74	76	78
2	●	30	1.438	.938	19.6	23	25	30	36	44	51	62	72	88	101	113	66	67	70
	●	35	1.438	1.063	23	26	30	35	42	51	59	72	84	102	118	132	68	70	73
	●	40	1.438	1.188	26	30	34	40	48	59	68	83	96	117	135	151	70	72	75
	●	45	1.438	1.297	29	34	38	45	54	66	76	93	108	132	152	170	72	74	78
	●	50	1.438	1.422	33	38	42	50	60	73	85	104	120	146	169	189	74	77	82
	●	60	1.438	1.563	39	45	51	60	72	88	101	124	143	176	203	227	77	79	84
2-1/2	●	60	1.875	1.422	39	45	51	60	72	88	101	124	143	176	203	227	67	68	71
	●	70	1.875	1.594	46	53	59	70	84	102	118	145	167	205	237	265	69	71	74
	●	80	1.875	1.734	52	60	68	80	96	117	135	166	191	234	270	302	71	73	77
	●	90	1.875	1.875	59	68	76	90	108	132	152	186	215	263	304	340	73	75	80
	●	100	1.875	2.000	65	76	85	100	120	146	169	207	239	293	338	378	77	79	83

Highlighted column shows the rated pressure.

PLACING YOUR ORDER

Call your local spray expert for application assistance or to place an order.



**PERFORMANCE DATA
STANDARD ANGLE SPRAY: CF, CRC**

Conn. Size (in.)	Nozzle Type		Capacity Size	Inlet Dia. Nom. (in.)	Orifice Dia. Nom. (in.)	Flow Rate Capacity (gallons per minute)										Spray Angle (°)		
	CF	CRC				3 psi	5 psi	7 psi	10 psi	20 psi	30 psi	40 psi	60 psi	80 psi	100 psi	7 psi	20 psi	60 psi
1-1/4		●	10-45	.844	.516	6.5	8.5	10.0	12.0	16.9	21	24	29	34	38	45	49	52
		●	12-45	.844	.563	7.9	10.1	12.0	14.3	20	25	29	35	41	45	45	49	51
		●	14-45	.844	.656	9.2	11.8	14.0	16.7	24	29	33	41	47	53	45	48	51
		●	16-45	.844	.750	10.5	13.5	16.0	19.1	27	33	38	47	54	60	45	48	50
		●	20-45	.844	.875	13.1	16.9	20	24	34	41	48	59	68	76	45	47	49
2		●	30-45	1.438	.938	19.6	25	30	36	51	62	72	88	101	113	45	49	52
		●	35-45	1.438	1.063	23	30	35	42	59	72	84	102	118	132	45	49	51
		●	40-45	1.438	1.188	26	34	40	48	68	83	96	117	135	151	45	48	50
		●	45-45	1.438	1.266	29	38	45	54	76	93	108	132	152	170	45	48	50
		●	50-45	1.438	1.375	33	42	50	60	85	104	120	146	169	189	45	47	49
3		●	55-45	1.438	1.453	36	46	55	66	93	114	131	161	186	208	45	47	49
		●	70	2.250	1.375	46	59	70	84	118	145	167	205	237	265	65	66	69
		●	85	2.250	1.578	56	72	85	102	144	176	203	249	287	321	67	68	71
		●	100	2.250	1.750	65	85	100	120	169	207	239	293	338	378	69	72	74
		●	120	2.250	2.063	79	101	120	143	203	248	287	351	406	454	71	73	77
		●	140	2.250	2.313	92	118	140	167	237	290	335	410	473	529	73	75	80
		●	70-45	2.250	1.375	46	59	70	84	118	145	167	205	237	265	45	49	52
		●	85-45	2.250	1.578	56	72	85	102	144	176	203	249	287	321	45	49	51
		●	100-45	2.250	1.750	65	85	100	120	169	207	239	293	338	378	45	48	51
		●	120-45	2.250	2.016	79	101	120	143	203	248	287	351	406	454	45	48	50
4		●	140-45	2.250	2.313	92	118	140	167	237	290	335	410	473	529	45	47	49
		●	150	3.125	2.000	98	127	150	179	254	311	359	439	507	567	66	67	70
		●	175	3.125	2.328	115	148	175	209	296	362	418	512	592	661	68	70	71
		●	200	3.125	2.688	131	169	200	239	338	414	478	586	676	756	70	72	74
		●	225	3.125	2.938	147	190	225	269	380	466	538	659	761	850	72	74	77
		●	250	3.125	3.250	164	211	250	299	423	518	598	732	845	945	74	76	81
		●	275	3.125	3.625	180	232	275	329	465	569	657	805	930	1039	78	80	83
		●	150-45	3.125	2.000	98	127	150	179	254	311	359	439	507	567	45	49	52
		●	175-45	3.125	2.328	115	148	175	209	296	362	418	512	592	661	45	49	51
		●	200-45	3.125	2.688	131	169	200	239	338	414	478	586	676	756	45	48	51
		●	225-45	3.125	2.938	147	190	225	269	380	466	538	659	761	850	45	48	50
6		●	250-45	3.125	3.250	164	211	250	299	423	518	598	732	845	945	45	47	49
		●	250	4.875	2.453	164	211	250	299	423	518	598	732	845	945	65	67	69
		●	300	4.875	2.750	196	254	300	359	507	621	717	878	1014	1134	66	68	70
		●	350	4.875	3.000	229	296	350	418	592	725	837	1025	1183	1323	68	70	72
		●	400	4.875	3.250	262	338	400	478	676	828	956	1171	1352	1512	70	73	75
		●	450	4.875	3.469	295	380	450	538	761	932	1076	1317	1521	1701	72	75	77
		●	500	4.875	3.828	327	423	500	598	845	1035	1195	1464	1690	1890	74	76	79
		●	550	4.875	4.266	360	465	550	657	930	1139	1315	1610	1859	2079	76	79	83
		●	625	4.875	5.125	409	528	625	747	1056	1294	1494	1830	2113	2362	78	81	86
		●	440-65	4.875	3.469	288	372	440	526	744	911	1052	1288	1487	1663	60	61	62
		●	550-65	4.875	4.266	360	465	550	657	930	1139	1315	1610	1859	2079	64	65	66
	●	625-65	4.875	5.125	409	528	625	747	1056	1294	1494	1830	2113	2362	65	66	67	

PERFORMANCE DATA

HOLLOW CONE
WHIRLJET® NOZZLES

STANDARD UNITS

PERFORMANCE DATA
STANDARD ANGLE SPRAY: D

Conn. Size (in.)	Nozzle Type D	Capacity Size	Inlet Dia. Nom. (in.)	Orifice Dia. Nom. (in.)	Flow Rate Capacity (gallons per minute)												Spray Angle (°)		
					3 psi	4 psi	5 psi	7 psi	10 psi	15 psi	20 psi	30 psi	40 psi	60 psi	80 psi	100 psi	10 psi	20 psi	60 psi
1/2	●	3	.438	.313	2.0	2.3	2.5	3.0	3.6	4.4	5.1	6.2	7.2	8.8	10.1	11.3	62	65	67
	●	4	.438	.391	2.6	3.0	3.4	4.0	4.8	5.9	6.8	8.3	9.6	11.7	13.5	15.1	68	71	73
	●	5	.438	.469	3.3	3.8	4.2	5.0	6.0	7.3	8.5	10.4	12.0	14.6	16.9	18.9	74	77	80
	●	7	.438	.547	4.6	5.3	5.9	7.0	8.4	10.2	11.8	14.5	16.7	20	24	26	77	80	83
3/4	●	4	.563	.359	2.6	3.0	3.4	4.0	4.8	5.9	6.8	8.3	9.6	11.7	13.5	15.1	63	66	67
	●	5	.563	.422	3.3	3.8	4.2	5.0	6.0	7.3	8.5	10.4	12.0	14.6	16.9	18.9	67	69	70
	●	6	.563	.484	3.9	4.5	5.1	6.0	7.2	8.8	10.1	12.4	14.3	17.6	20	23	71	73	77
	●	7	.563	.547	4.6	5.3	5.9	7.0	8.4	10.2	11.8	14.5	16.7	20	24	26	73	75	80
	●	10	.563	.656	6.5	7.6	8.5	10.0	12.0	14.6	16.9	21	24	29	34	38	77	80	84

Highlighted column shows the rated pressure.

PERFORMANCE DATA
STANDARD ANGLE SPRAY: AP, LAP, LBP

Nozzle Type/ Conn. Size (in.)					Capacity Size	Inlet Dia. Nom. (in.)	Orifice Dia. Nom. (in.)	Flow Rate Capacity (gallons per minute)												Spray Angle (°)		
AP		LAP		LBP				3 psi	5 psi	7 psi	10 psi	20 psi	30 psi	40 psi	60 psi	80 psi	100 psi	10 psi	20 psi	80 psi		
1/4	3/8	3/8	1/2	3/8																		
●	●				2	.078	.078	–	.14	.17	.20	.28	.35	.40	.49	.57	.63	53	70	80		
●	●				2-3	.078	.094	–	.17	.20	.24	.34	.42	.48	.59	.68	.76	61	76	83		
●	●				2-5	.078	.109	–	.20	.23	.28	.40	.48	.56	.69	.79	.89	63	81	90		
●	●				2-8	.078	.141	–	.23	.28	.33	.47	.57	.66	.81	.93	1.0	71	87	95		
●	●				2-10	.078	.172	–	.25	.30	.36	.51	.62	.72	.88	1.0	1.1	72	94	104		
●	●				2-15	.078	.203	–	.28	.33	.39	.55	.68	.78	.96	1.1	1.2	77	100	111		
●	●				2-20	.078	.234	–	.31	.37	.44	.62	.76	.88	1.1	1.2	1.4	81	103	113		
●	●				3-2	.094	.078	–	.18	.22	.26	.37	.45	.52	.64	.74	.82	58	67	76		
●	●				3	.094	.094	–	.21	.23	.30	.43	.52	.60	.73	.85	.95	55	79	80		
●	●				3-5	.094	.109	–	.25	.30	.36	.51	.62	.72	.88	1.0	1.1	72	82	86		
●	●				3-8	.094	.141	–	.31	.37	.44	.62	.76	.88	1.1	1.2	1.4	73	88	92		
●	●				3-10	.094	.172	–	.34	.40	.48	.68	.83	.96	1.2	1.4	1.5	81	94	97		
●	●				3-15	.094	.203	–	.39	.46	.55	.78	.95	1.1	1.3	1.6	1.7	83	93	100		
●	●				3-20	.094	.234	–	.44	.52	.62	.88	1.1	1.2	1.5	1.8	2.0	90	100	107		
●	●				5-2	.141	.078	–	–	–	.36	.51	.62	.72	.88	1.0	1.1	49	61	67		
●	●				5-3	.141	.094	–	–	.34	.41	.58	.71	.82	1.0	1.2	1.3	57	68	69		
●	●				5	.141	.109	–	.35	.42	.50	.70	.86	1.0	1.2	1.4	1.6	70	75	79		
●	●				5-8	.141	.141	–	.42	.50	.60	.85	1.0	1.2	1.5	1.7	1.9	80	78	82		
●	●				5-10	.141	.172	–	.48	.56	.67	1.0	1.2	1.4	1.7	1.9	2.1	80	87	89		
●	●				5-15	.141	.203	–	.57	.67	.80	1.1	1.4	1.6	2.0	2.3	2.6	83	91	95		
●	●				5-20	.141	.234	–	.61	.72	.86	1.2	1.5	1.7	2.1	2.4	2.7	88	98	102		
●	●				8-5	.172	.109	–	.42	.50	.60	.85	1.0	1.2	1.5	1.7	1.9	60	68	71		



PERFORMANCE DATA
STANDARD ANGLE SPRAY: AP, LAP, LBP

Nozzle Type/ Conn. Size (in.)					Capacity Size	Inlet Dia. Nom. (in.)	Orifice Dia. Nom. (in.)	Flow Rate Capacity (gallons per minute)										Spray Angle (°)		
AP		LAP		LBP				3 psi	5 psi	7 psi	10 psi	20 psi	30 psi	40 psi	60 psi	80 psi	100 psi	10 psi	20 psi	80 psi
1/4	3/8	3/8	1/2	3/8																
•	•				8	.172	.141	.44	.57	.67	.80	1.1	1.4	1.6	2.0	2.3	2.5	65	72	74
•	•				8-10	.172	.172	.51	.66	.79	.94	1.3	1.6	1.9	2.3	2.7	3.0	73	81	81
•	•				8-15	.172	.203	.59	.76	.90	1.1	1.5	1.9	2.2	2.6	3.1	3.4	78	84	87
•	•				8-20	.172	.234	.65	.83	.99	1.2	1.7	2.0	2.4	2.9	3.3	3.7	84	89	92
•	•				10-5	.188	.109	–	–	.54	.65	.92	1.1	1.3	1.6	1.8	2.0	55	64	67
•	•				10-8	.188	.141	–	.61	.72	.86	1.2	1.5	1.7	2.1	2.4	2.7	60	64	66
•	•				10	.188	.172	.55	.72	.84	1.0	1.4	1.7	2.0	2.4	2.8	3.1	70	76	75
•	•				10-15	.188	.203	.67	.86	1.0	1.2	1.7	2.1	2.4	3.0	3.5	3.9	76	81	79
•	•				10-20	.188	.234	.75	1.0	1.2	1.4	2.0	2.4	2.8	3.5	3.9	4.4	78	85	98
•	•				15-5	.234	.109	–	–	–	.76	1.1	1.3	1.5	1.9	2.2	2.4	52	65	60
•	•				15-8	.234	.141	–	–	.85	1.0	1.4	1.8	2.0	2.5	2.9	3.2	55	68	64
•	•				15-10	.234	.172	–	.85	1.0	1.2	1.7	2.1	2.4	2.9	3.4	3.8	65	75	71
•	•				15	.234	.203	.82	1.1	1.3	1.5	2.1	2.6	3.0	3.7	4.2	4.7	70	72	75
•	•				15-20	.234	.234	.93	1.2	1.4	1.7	2.4	2.9	3.4	4.2	4.8	5.4	78	80	82
		•			20-5	.250	.125	–	–	–	.83	1.2	1.4	1.7	2.0	2.3	2.6	33	40	55
		•			20-8	.250	.172	–	–	.90	1.1	1.5	1.9	2.2	2.6	3.1	3.4	40	47	60
		•			20-10	.250	.188	–	.97	1.2	1.4	2.0	2.4	2.8	3.4	3.9	4.4	39	55	65
		•			20-15	.250	.234	.99	1.3	1.5	1.8	2.5	3.1	3.6	4.4	5.1	5.7	55	63	68
		•			20	.250	.250	1.1	1.4	1.7	2.0	2.8	3.5	4.0	4.9	5.6	6.3	59	66	70
		•			20-25	.250	.297	1.4	1.8	2.1	2.5	3.5	4.3	5.0	6.2	7.1	7.9	60	73	77
		•			20-40	.250	.359	1.6	2.0	2.4	2.9	4.0	5.0	5.7	7.0	8.1	9.0	80	82	86
		•			20-50	.250	.438	1.9	2.5	2.9	3.5	4.9	6.1	7.0	8.5	9.9	11.0	83	90	97
		•			20-60	.250	.516	2.2	2.8	3.3	4.0	5.7	6.9	8.0	9.8	11.3	12.6	86	94	99
		•			25-8	.281	.172	–	–	–	1.2	1.7	2.1	2.4	2.9	3.4	3.8	27	42	57
		•			25-10	.281	.188	.82	1.1	1.3	1.5	2.1	2.6	3.0	3.7	4.2	4.7	35	50	59
		•			25-15	.281	.234	1.0	1.3	1.6	1.9	2.7	3.3	3.8	4.6	5.3	6.0	44	57	64
		•			25-20	.281	.250	1.2	1.5	1.8	2.2	3.1	3.7	4.3	5.3	6.1	6.8	53	63	68
		•			25	.281	.297	1.4	1.8	2.1	2.5	3.5	4.3	5.0	6.2	7.1	7.9	60	70	74
		•			25-40	.281	.359	1.7	2.2	2.7	3.2	4.5	5.5	6.4	7.8	9.0	10.1	69	73	79
		•			25-50	.281	.438	2.1	2.8	3.3	3.9	5.5	6.8	7.8	9.6	11.0	12.3	76	81	85
		•			25-60	.281	.516	2.5	3.2	3.8	4.5	6.4	7.8	9.0	11.0	12.7	14.2	83	86	92
		•	•	•	40-8	.359	.172	–	–	–	1.5	2.2	2.7	3.1	3.7	4.3	4.8	30	41	48
		•	•	•	40-10	.359	.188	–	–	1.5	1.8	2.5	3.1	3.6	4.4	5.1	5.7	34	45	53
		•	•	•	40-15	.359	.234	1.3	1.7	2.0	2.4	3.4	4.2	4.9	5.9	6.9	7.7	44	48	57
		•	•	•	40-20	.359	.250	1.5	1.9	2.2	2.7	3.8	4.6	5.3	6.5	7.5	8.4	45	52	59
		•	•	•	40-25	.359	.297	1.8	2.3	2.7	3.2	4.5	5.5	6.4	7.8	9.0	10.1	48	56	61
		•	•	•	40	.359	.359	2.2	2.8	3.3	4.0	5.7	6.9	8.0	9.8	11.3	12.6	67	71	73
		•	•	•	40-50	.359	.438	2.8	3.6	4.2	5.0	7.1	8.7	10.0	12.3	14.1	15.9	68	80	84
		•	•	•	40-50.1	.359	.422	2.8	3.6	4.2	5.0	7.1	8.7	10.0	12.3	14.1	15.9	40	47	50
		•	•	•	40-60	.359	.516	3.3	4.2	5.0	6.0	8.4	10.3	11.9	14.6	16.7	18.9	80	86	90



PERFORMANCE DATA

HOLLOW CONE
WHIRLJET® NOZZLES

STANDARD UNITS

PERFORMANCE DATA
STANDARD ANGLE SPRAY: BD

Conn. Size (in.)	Nozzle Type BD	Capacity Size	Inlet Dia. Nom. (in.)	Orifice Dia. Nom. (in.)	Flow Rate Capacity (gallons per minute)											Spray Angle (°)		
					3 psi	5 psi	7 psi	10 psi	15 psi	20 psi	30 psi	40 psi	60 psi	80 psi	100 psi	7 psi	20 psi	80 psi
3/8	●	2	.094	.078	.11	.14	.17	.20	.24	.28	.35	.40	.49	.57	.63	51	60	70
	●	3	.094	.094	.16	.21	.25	.30	.37	.42	.52	.60	.73	.85	.95	52	64	77
	●	5	.109	.125	.27	.35	.42	.50	.61	.71	.87	1.0	1.2	1.4	1.6	56	67	76
	●	8	.156	.156	.44	.57	.67	.80	.98	1.1	1.4	1.6	2.0	2.3	2.5	56	65	70
	●	10	.156	.172	.55	.71	.84	1.0	1.2	1.4	1.7	2.0	2.4	2.8	3.2	55	65	72
	●	20-10	.156*	.172	.99	4.0	1.1	1.4	1.7	1.9	2.4	2.7	3.3	3.8	4.3	61	65	67
1/2	●	5	.125	.141	.27	.35	.42	.50	.61	.71	.87	1.0	1.2	1.4	1.6	63	73	79
	●	8	.156	.156	.44	.57	.67	.80	.98	1.1	1.4	1.6	2.0	2.3	2.5	61	69	73
	●	10	.172	.172	.55	.71	.84	1.0	1.2	1.4	1.7	2.0	2.4	2.8	3.2	63	70	74
	●	15	.172*	.203	.82	1.1	1.3	1.5	1.8	2.1	2.6	3.0	3.7	4.2	4.7	60	67	70
	●	20	.188*	.234	1.1	1.4	1.7	2.0	2.4	2.8	3.5	4.0	4.9	5.7	6.3	63	65	69
	●	25	.203*	.281	1.4	1.8	2.1	2.5	3.1	3.5	4.3	5.0	6.1	7.1	7.9	59	63	68
3/4	●	5	.141	.125	.27	.35	.42	.50	.61	.71	.87	1.0	1.2	1.4	1.6	64	73	79
	●	8	.172	.156	.44	.57	.67	.80	.98	1.1	1.4	1.6	2.0	2.3	2.5	62	70	74
	●	10	.203	.172	.55	.71	.84	1.0	1.2	1.4	1.7	2.0	2.4	2.8	3.2	64	72	75
	●	15	.250	.219	.82	1.1	1.3	1.5	1.8	2.1	2.6	3.0	3.7	4.2	4.7	64	72	74
	●	20	.281	.250	1.1	1.4	1.7	2.0	2.4	2.8	3.5	4.0	4.9	5.7	6.3	63	70	74
	●	25	.281	.297	1.4	1.8	2.1	2.5	3.1	3.5	4.3	5.0	6.1	7.1	7.9	63	70	74
	●	50-50.3	.281*	.375	2.7	3.5	4.2	5.0	6.0	7.0	8.5	10.0	12.2	14.1	15.8	70	72	73
1-1/2	●	40	.375*	.313	2.2	2.8	3.3	4.0	4.9	5.7	6.9	8.0	9.8	11.3	12.6	70	73	74
	●	50	.375*	.375	2.7	3.5	4.2	5.0	6.1	7.1	8.7	10.0	12.2	14.1	15.8	72	75	77
	●	60	.375*	.438	3.3	4.2	5.0	6.0	7.3	8.5	10.4	12.0	14.7	17.0	19.0	74	76	79
	●	70	.375*	.500	3.8	4.9	5.9	7.0	8.6	9.9	12.1	14.0	17.1	19.8	22	76	79	83
	●	80	.375*	.563	4.4	5.7	6.7	8.0	9.8	11.3	13.9	16.0	19.6	23	25	78	82	84
	●	90	.375*	.578	4.9	6.4	7.5	9.0	11.0	12.7	15.6	18.0	22	25	28	81	84	84
	●	100	.375*	.625	5.5	7.1	8.4	10.0	12.2	14.1	17.3	20	24	28	32	83	86	86
	●	110	.375*	.672	6.0	7.8	9.2	11.0	13.5	15.6	19.1	22	27	31	35	85	88	88
	●	120	.375*	.719	6.6	8.5	10.0	12.0	14.7	17.0	21	24	29	34	38	87	90	90

*Dual inlets, each in diameter specified.
Highlighted column shows the rated pressure.

PLACING YOUR ORDER

Call your local spray expert for application assistance or to place an order.



PERFORMANCE DATA
STANDARD ANGLE SPRAY: BDM

Conn. Size (in.)	Nozzle Type	Capacity Size	Orifice Dia. Nom. (in.)	Flow Rate Capacity (gallons per minute)								Spray Angle (°)		
				10 psi	20 psi	40 psi	100 psi	200 psi	300 psi	400 psi	500 psi	20 psi	100 psi	500 psi
3/8	●	2-0.5	.047	–	–	.16	.25	.36	.44	.51	.57	–	52	45
	●	2-1	.063	–	.16	.22	.36	.51	.62	.72	.80	53	65	50
	●	2	.078	.20	.28	.40	.63	.89	1.1	1.3	1.4	60	69	62
	●	3-2	.078	.22	.31	.44	.69	.98	1.2	1.4	1.6	57	68	58
	●	3	.094	.30	.42	.60	.95	1.3	1.6	1.9	2.1	64	75	64
	●	5	.125	.50	.71	1.0	1.6	2.2	2.7	3.2	3.5	73	78	72
	●	10-2	.078	.35	.49	.70	1.1	1.6	1.9	2.2	2.5	30	46	40
	●	20-10	.172	1.4	1.9	2.7	4.3	6.0	7.4	8.5	9.5	61	60	49

Maximum recommended operating pressure is 500 psi (34.5 bar).
Highlighted column shows the rated pressure.

STANDARD UNITS

PLACING YOUR ORDER

Call your local spray expert for application assistance or to place an order.



PERFORMANCE DATA
WIDE ANGLE SPRAY: AX-W, BX-W

Conn. Size (in.)	Nozzle Type		Capacity Size	Inlet Dia. Nom. (in.)	Orifice Dia. Nom. (in.)	Flow Rate Capacity (gallons per minute)								Spray Angle (°)			
	AX-W	BX-W				5 psi	7 psi	10 psi	15 psi	20 psi	30 psi	40 psi	60 psi	80 psi	10 psi	20 psi	80 psi
1/8	●	●	0.5-0.5W	.031	.047	–	–	.05	.06	.07	.09	.10	.12	.14	103	117	98
	●	●	1-1W	.063	.063	–	–	.10	.12	.14	.17	.20	.25	.28	110	125	110
	●	●	2-3W	.078	.109	–	.21	.25	.31	.35	.43	.50	.61	.71	114	114	97
	●	●	3-3W	.094	.109	–	.25	.30	.37	.42	.52	.60	.73	.85	114	114	97
	●	●	3-5W	.094	.125	–	.29	.34	.42	.48	.59	.68	.83	.96	116	110	95
	●	●	2-10W	.078	.172	–	.35	.41	.51	.59	.72	.82	1.0	1.2	130	135	120
	●	●	5-5W	.125	.125	–	.42	.50	.61	.71	.86	1.0	1.2	1.4	116	110	92
	●	●	5-10W	.125	.172	.46	.54	.65	.80	.92	1.1	1.3	1.6	1.8	126	121	95
	●	●	8-10W	.156	.172	.64	.75	.90	1.1	1.3	1.6	1.8	2.2	2.5	124	112	90
1/4	●	●	1-1W	.063	.063	–	–	.10	.12	.14	.17	.20	.25	.28	110	117	111
	●	●	1-5W	.063	.125	–	–	.17	.21	.24	.29	.34	.42	.48	100	123	124
	●	●	1-10W	.063	.172	–	–	.21	.26	.30	.36	.42	.51	.60	140	144	139
	●	●	1-15W	.063	.219	–	–	.24	.29	.34	.42	.48	.59	.68	105	128	132
	●	●	2-5W	.078	.125	–	.29	.34	.42	.49	.60	.68	.84	.89	118	123	113
	●	●	2-10W	.078	.172	–	.35	.41	.51	.59	.72	.82	1.0	1.2	138	136	126
	●	●	5-5W	.141	.125	–	.42	.50	.61	.71	.86	1.0	1.2	1.4	114	113	104
	●	●	5-10W	.141	.172	.46	.54	.65	.80	.92	1.1	1.3	1.6	1.8	130	130	119
	●	●	5-15W	.141	.219	.52	.64	.77	.94	1.1	1.3	1.5	1.8	2.2	130	132	120
	●	●	8-10W	.156	.172	.64	.75	.90	1.1	1.3	1.6	1.8	2.2	2.5	129	122	103
	●	●	10-10W	.188	.172	.71	.84	1.0	1.2	1.4	1.7	2.0	2.5	2.8	120	108	95
	●	●	8-15W	.156	.219	.78	.92	1.1	1.4	1.6	1.9	2.2	2.7	3.1	129	122	107
	●	●	10-15W	.188	.219	.86	1.0	1.2	1.5	1.7	2.1	2.4	3.0	3.4	120	108	97
	●	●	15-15W	.234	.219	1.1	1.3	1.5	1.8	2.1	2.6	3.0	3.7	4.2	101	95	88
3/8	●	●	5-10W	.141	.172	.46	.54	.65	.80	.92	1.1	1.3	1.6	1.8	130	123	102
	●	●	5-15W	.141	.219	.52	.64	.77	.94	1.1	1.3	1.5	1.8	2.2	138	131	112
	●	●	8-10W	.172	.172	.64	.75	.90	1.1	1.3	1.6	1.8	2.2	2.5	122	110	96
	●	●	10-10W	.203	.172	.71	.84	1.0	1.2	1.4	1.7	2.0	2.5	2.8	116	108	93
	●	●	8-15W	.172	.219	.78	.92	1.1	1.4	1.6	1.9	2.2	2.7	3.1	133	120	105
	●	●	10-15W	.203	.219	.86	1.0	1.2	1.5	1.7	2.1	2.4	3.0	3.4	126	115	100
	●	●	8-25W	.172	.297	.92	1.1	1.3	1.6	1.9	2.3	2.6	3.2	3.7	122	118	109
	●	●	10-20W	.203	.234	.97	1.1	1.4	1.7	1.9	2.4	2.7	3.3	3.9	118	112	102
	●	●	15-15W	.234	.219	1.1	1.3	1.5	1.8	2.1	2.6	3.0	3.7	4.2	116	106	95
	●	●	15-20W	.234	.234	1.2	1.5	1.7	2.1	2.5	3.0	3.5	4.3	4.9	113	108	98
	●	●	20-20W	.281	.234	1.4	1.7	2.0	2.4	2.8	3.5	4.0	4.9	5.6	106	102	95
	●	●	15-30W	.234	.313	1.6	1.8	2.2	2.7	3.1	3.8	4.4	5.4	6.2	116	110	102
	●	●	25-25W	.297	.297	1.8	2.1	2.5	3.1	3.5	4.3	5.0	6.1	7.1	105	100	93
1/2	●	●	25-30W	.297	.313	2.0	2.3	2.8	3.4	4.0	4.9	5.6	6.9	7.9	105	101	94
	●	●	50-50W	.375	.438	3.5	4.2	5.0	6.1	7.1	8.6	10.0	12.3	14.2	110	102	93

Intermediate capacities: Caps are interchangeable for in-between capacities within each pipe size group. Request Data Sheets 3055, 3986 and 3987.
Spray dimension data: Request Data Sheets 15350 and 15362.

Highlighted column shows the rated pressure.



PERFORMANCE DATA
WIDE ANGLE SPRAY: LAP-W, LBP-W

Nozzle Type/ Conn. Size (in.)			Capacity Size	Inlet Dia. Nom. (in.)	Orifice Dia. Nom. (in.)	Flow Rate Capacity (gallons per minute)										Spray Angle (°)		
LAP-W		LBP-W				3 psi	5 psi	7 psi	10 psi	20 psi	30 psi	40 psi	60 psi	80 psi	100 psi	7 psi	20 psi	80 psi
3/8	1/2	3/8																
●			20-8W	.250	.172	–	–	.90	1.1	1.5	1.9	2.2	2.6	3.1	3.4	99	96	86
●			20-10W	.250	.188	–	.94	1.2	1.4	2.0	2.4	2.8	3.4	3.9	4.4	101	98	88
●			20-15W	.250	.219	.99	1.3	1.5	1.8	2.5	3.1	3.6	4.4	5.1	5.7	104	100	91
●			20-20W	.250	.250	1.1	1.4	1.7	2.0	2.8	3.5	4.0	4.9	5.6	6.3	106	101	93
●			20-25W	.250	.281	1.4	1.8	2.1	2.5	3.5	4.3	5.0	6.2	7.1	7.9	109	104	95
●			20-40W	.250	.344	1.6	2.0	2.4	2.9	4.0	5.0	5.7	7.0	8.1	9.0	110	107	98
●			20-50W	.250	.406	1.9	2.5	2.9	3.5	4.9	6.1	7.0	8.5	9.9	11.0	111	108	100
●			25-8W	.281	.172	–	–	–	1.2	1.7	2.1	2.4	2.9	3.4	3.8	–	89	78
●			25-10W	.281	.188	–	–	1.3	1.5	2.1	2.6	3.0	3.7	4.2	4.7	100	92	81
●			25-15W	.281	.219	–	1.3	1.6	1.9	2.7	3.3	3.8	4.6	5.3	6.0	102	96	85
●			25-20W	.281	.250	1.2	1.5	1.8	2.2	3.1	3.7	4.3	5.3	6.1	6.8	104	99	88
●			25-25W	.281	.281	1.4	1.8	2.1	2.5	3.5	4.3	5.0	6.2	7.1	7.9	107	102	91
●			25-40W	.281	.344	1.7	2.2	2.7	3.2	4.5	5.5	6.4	7.8	9.0	10.1	109	105	94
●			25-50W	.281	.406	2.1	2.8	3.3	3.9	5.5	6.8	7.8	9.6	11.0	12.3	110	108	99
●	●	●	40-10W	.359	.188	–	–	1.5	1.8	2.5	3.1	3.6	4.4	5.1	5.7	95	85	80
●	●	●	40-15W	.359	.219	1.3	1.7	2.0	2.4	3.4	4.2	4.9	5.9	6.9	7.7	97	88	82
●	●	●	40-20W	.359	.250	1.5	1.9	2.2	2.7	3.8	4.6	5.3	6.5	7.5	8.4	100	94	88
●	●	●	40-25W	.359	.281	1.8	2.3	2.7	3.2	4.5	5.5	6.4	7.8	9.0	10.1	103	97	91
●	●	●	40-40W	.359	.344	2.2	2.8	3.3	4.0	5.7	6.9	8.0	9.8	11.3	12.6	106	99	93
●	●	●	40-50W	.359	.406	2.8	3.6	4.2	5.0	7.1	8.7	10.0	12.3	14.1	15.9	109	101	96

Highlighted column shows the rated pressure.

PLACING YOUR ORDER

Call your local spray expert for
application assistance or to place an order.

DIMENSIONS AND WEIGHTS

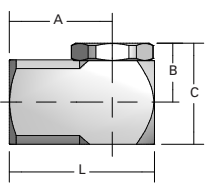
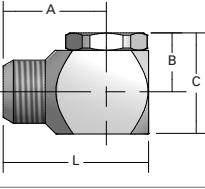
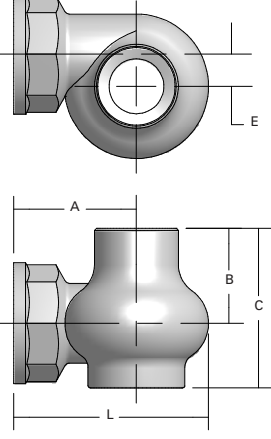
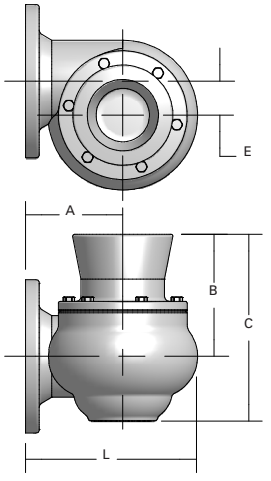
Nozzle	Nozzle Type	Conn. Size/Type (in.)	L (in.)	A (in.)	B (in.)	C (in.)	E (in.)	Net Weight (oz.)
	AX AX-W	1/8 female	1.000	0.688	0.469	0.781	–	1.5
		1/4 female	1.250	0.875	0.531	0.906	–	2.8
		3/8 female	1.469	1.031	0.688	1.125	–	4.3
		1/2 female	1.938	1.375	0.844	1.565	–	8.8
		3/4 female	2.188	1.375	1.563	1.250	–	11
	BX BX-W	1/8 male	1.188	0.875	0.652	1.375	–	1.5
		1/4 male	1.375	1.000	0.531	1.563	–	2.5
		3/8 male	1.563	1.125	0.688	1.563	–	4
		1/2 male	1.938	1.375	0.844	1.938	–	7
		3/4 male	2.250	1.625	1.563	1.250	–	10.8
	CX	1 female	2.625	1.750	1.250	1.844	0.348	11
		1-1/4 female	3.063	2.063	1.313	2.188	0.438	20
		1-1/2 female	3.688	2.438	1.500	2.875	0.563	28
		2 female	4.531	3.688	2.109	3.688	0.719	48
		2-1/2 female	5.531	3.500	2.688	4.500	0.469	68
	CF	4 Flange	8.250	4.406	9.250	12.375	1.563	114
		6 Flange	12.250	6.875	8.688	13.313	2.438	126

Based on the largest/heaviest version of each type.

DIMENSIONS AND WEIGHTS

STANDARD UNITS

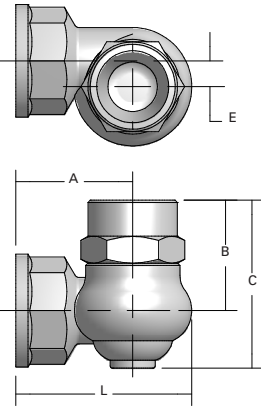
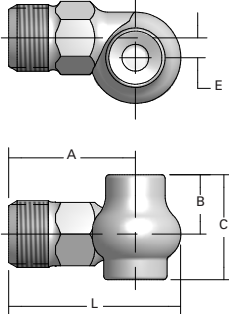
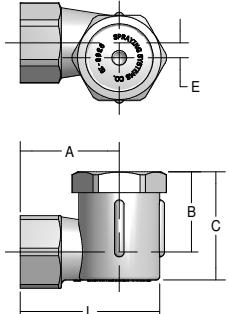
Nozzle	Nozzle Type	Conn. Size/Type (in.)	L (in.)	A (in.)	B (in.)	C (in.)	E (in.)	Net Weight (oz.)
	CRC	1-1/4 female	3.406	2.125	2.094	3.063	0.406	36
		2 female	4.844	3.188	3.063	4.656	0.719	80
		3 female	6.938	4.438	5.938	8.406	1.125	19
		4 female	9.000	5.563	9.125	12.250	1.563	40
	D	1/2 male	2.313	1.750	0.719	1.313	0.250	5
		3/4 male	2.719	2.000	0.938	1.656	0.313	7.5
	AP AP-W	1/4 female	1.438	1.000	0.866	1.157	0.156	0.4
		3/8 female	1.469	1.094	0.866	1.157	0.156	0.4
	LAP LAP-W	3/8 female	1.906	1.281	1.182	1.596	0.192	0.6
		1/2 female	2.031	1.406	1.182	1.596	0.192	0.8

Based on the largest/heaviest version of each type.

DIMENSIONS AND WEIGHTS

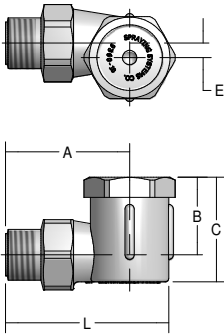
Nozzle	Nozzle Type	Conn. Size/Type (in.)	L (in.)	A (in.)	B (in.)	C (in.)	E (in.)	Net Weight (oz.)
	LBP LBP-W	3/8 male	2.094	1.563	1.236	1.596	0.192	.6

Based on the largest/heaviest version of each type.

DIMENSIONS AND WEIGHTS

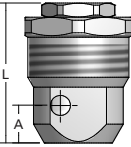
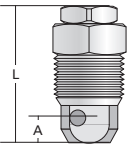
Nozzle	Nozzle Type	Conn. Size/Type (in.)	L (in.)	Hex. (in.)	A (in.)	Net Weight (oz.)
	BD	3/8 male	1.250	11/16	.266	1
		1/2 male	1.469	7/8	.311	2
		3/4 male	1.750	1-1/16	.375	4
		1-1/2 male	2.625	2	.311	21
	BDM	3/8 male	0.281	11/16	.266	.5

Based on the largest/heaviest version of each type.

PLACING YOUR ORDER

Call your local spray expert for application assistance or to place an order.

S PERFORMANCE DATA
STANDARD ANGLE SPRAY

Conn. Size (in.)	Nozzle Type	Spray Angle at 10 psi					Capacity Size	Orifice Dia. Nom. (in.)	Max. Free Passage Dia. (in.)	Flow Rate Capacity (gallons per minute)					
		BSJ	50°	60°	90°	120°				180°	5 psi	10 psi	20 psi	40 psi	100 psi
1/4	•	•	•	•	•		07	.094	.094	.49	.70	.99	1.4	2.2	4.4
	•	•	•	•	•	•	13	.125	.125	.92	1.3	1.8	2.6	4.1	8.2
	•	•	•	•	•	•	20	.156	.125	1.4	2.0	2.8	4.0	6.3	12.6
3/8	•	•	•	•	•	•	30	.188	.125	2.1	3.0	4.2	6.0	9.5	19.0
	•	•	•	•	•	•	40	.219	.125	2.8	4.0	5.7	8.0	12.6	25
	•	•	•	•	•	•	53	.250	.125	3.7	5.3	7.5	10.6	16.8	34
	•	•	•	•	•	•	82	.313	.125	5.8	8.2	11.6	16.4	26	52
1/2	•	•	•	•	•	•	120	.375	.188	8.5	12.0	17.0	24	38	76
	•	•	•	•	•	•	164	.438	.188	11.6	16.4	23	33	52	104
3/4	•	•	•	•	•	•	210	.500	.188	14.8	21	30	42	66	133
1	•		•	•	•	•	340	.625	.250	24	34	48	68	108	215
	•		•	•	•	•	470	.750	.250	33	47	66	94	149	297
1-1/2	•		•	•	•	•	640	.875	.313	45	64	91	128	202	405
	•		•	•	•	•	820	1.000	.313	58	82	116	164	259	519
	•		•	•	•	•	960	1.125	.313	68	96	136	192	304	607
2	•		•	•	•	•	1400	1.375	.438	99	140	198	280	443	885
	•		•	•	•	•	1780	1.500	.438	126	178	252	356	563	1126

Maximum Free Passage Diameter is the maximum diameter as listed of foreign matter that can pass through the nozzle without clogging. For all 1/4" and 3/8" connections, optimum spray angle is achieved at 40 psi (2.8 bar).
 *Maximum operating pressure depends on material, size and application. Contact your local sales engineer for specific recommendations.
Highlighted column shows the rated pressure.

DIMENSIONS AND WEIGHTS

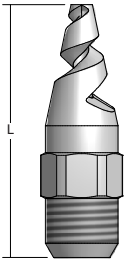
Nozzle	Nozzle Type	Conn. Size (in.)	L (in.)	Hex. / flats (in.)	Net Weight (oz.)
	BSJ (M)	1/4	1.875	9/16	1
		3/8	1.875	11/16	1.8
		1/2	2.500	7/8	3
		3/4	2.750	1-1/16	5
		1	3.625	1-3/8	11
		1-1/2	4.375	2	27
		2	6.875	2-1/2	48

Based on the largest/heaviest version of each type.

PERFORMANCE DATA
SOLID STREAM SPRAY: 73196, 73327, 37337, 38553, 39468

Spray Angle at 60 bar	Capacity Size	Equiv. Orifice Dia. (mm)	Flow Rate Capacity (liters per minute)				
			1.5 bar	3.0 bar	7.0 bar	20 bar	55 bar
0° (solid stream)	00003	.38	.08	.12	.18	.31	.49
	00005	.51	.14	.20	.30	.51	.85
	00008	.64	.23	.32	.48	.82	1.4
	00011	.76	.39	.55	.84	1.40	2.4
	00015	.89	.50	.71	1.09	1.80	3.1
	00020	1.02	.64	.91	1.40	2.30	3.9
	00025	1.14	.78	1.11	1.70	2.85	4.8

Highlighted column shows the rated pressure.

DIMENSIONS

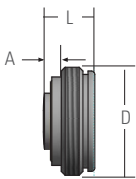
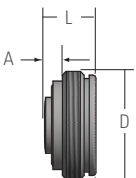
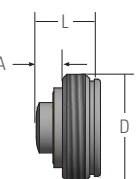
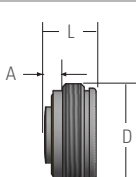
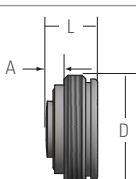
Nozzle	Nozzle Type	Thread Size	L (mm)	A (mm)	D (Dia.) (mm)
	73196-A	1-3/16"-18 or M30 x 1.5	16.8	6.9	30.2
	73196-B		16.0	6.1	
	73196-C		18.5	8.6	
	73196-D		12.2	5.3	
	73327-A	1-1/4"-18 or M32 x 1.5	16.8	6.9	31.8
	73327-B		16.0	6.1	
	73327-C		18.5	8.6	
	73327-D		15.2	5.3	
	39468-A	1-3/16"-18 or M30 x 1.5	19.3	6.9	30.2
	39468-B		18.5	6.1	
	39468-C		21.1	8.6	
	39468-D		17.8	5.3	
	37337-A	1-3/16"-18 or M30 x 1.5	16.8	6.9	30.2
	37337-B		16.0	6.1	
	37337-C		18.5	8.6	
	37337-D		15.2	5.3	
	38553-A	1-1/4"-18 or M32 x 1.5	16.8	6.9	51.8
	38553-B		16.0	6.1	
	38553-C		18.5	8.6	
	38553-D		15.2	5.3	

**PERFORMANCE DATA
FLAT SPRAY: 27149**

Spray Angle at 4.0 bar	Nozzle Type	Capacity Size	Equiv. Orifice Dia. (mm)	Flow Rate Capacity (liters per minute)				
	27149			1.5 bar	3.0 bar	7.0 bar	20 bar	55 bar
75°	•	7502	1.0	.64	.91	1.4	2.3	3.9
	•	7503	1.2	.92	1.3	2.0	3.4	5.6
	•	7504	1.5	1.2	1.7	2.6	4.4	7.3
	•	7506	1.8	1.7	2.4	3.7	6.2	10.3
	•	7508	2.0	2.2	3.1	4.8	8.1	13.4
	•	7510	2.2	2.8	4.0	6.2	10.4	17.2
	•	7512	2.5	3.5	4.9	7.5	12.6	21
	•	7516	2.8	4.5	6.3	9.7	16.4	27
	•	7520	3.0	5.5	7.8	11.9	20	33
	•	7525	3.5	7.2	10.1	15.5	26	43
	•	7531	4.0	8.8	12.4	18.9	32	53
	•	7540	4.5	11.3	15.9	24	41	68
	•	7549	5.0	13.7	19.4	30	50	83
	•	7578	6.0	22	31	48	81	133
	•	7599	7.0	28	39	60	101	167
	•	75124	8.0	35	49	75	126	210
60°	•	6002	1.0	.64	.91	1.4	2.3	3.9
	•	6003	1.2	.92	1.3	2.0	3.4	5.6
	•	6004	1.5	1.2	1.7	2.6	4.4	7.3
	•	6006	1.8	1.7	2.4	3.7	6.2	10.3
	•	6008	2.0	2.2	3.1	4.8	8.1	13.4
	•	6010	2.2	2.8	4.0	6.2	10.4	17.2
	•	6012	2.5	3.5	4.9	7.5	12.6	21
	•	6016	2.8	4.5	6.3	9.7	16.4	27
	•	6020	3.0	5.5	7.8	11.9	20	33
	•	6025	3.5	7.2	10.1	15.5	26	43
	•	6031	4.0	8.8	12.4	18.9	32	53
	•	6040	4.5	11.3	15.9	24	41	68
	•	6049	5.0	13.7	19.4	30	50	83
	•	6064	5.5	17.0	24.2	38.2	61	108
	•	6078	6.0	22	31	47	80	133
	•	6099	7.0	28	39	60	101	167
•	60124	8.0	35	49	75	126	210	
45°	•	4502	1.0	.64	.91	1.4	2.3	3.9
	•	4503	1.2	.92	1.3	2	3.4	5.6
	•	4504	1.5	1.2	1.7	2.6	4.4	7.3
	•	4506	1.8	1.7	2.4	3.7	6.2	10.3
	•	4508	2.0	2.2	3.1	4.8	8.1	13.4
	•	4510	2.2	2.8	4.0	6.2	10.4	17.2

Highlighted column shows the rated pressure.



PERFORMANCE DATA

SHOWER NOZZLES
SHOWERJET DISC-TYPE NOZZLES

METRIC UNITS

PERFORMANCE DATA
FLAT SPRAY: 27149

Spray Angle at 4.0 bar	Nozzle Type	Capacity Size	Equiv. Orifice Dia. (mm)	Flow Rate Capacity (liters per minute)				
	27149			1.5 bar	3.0 bar	7.0 bar	20 bar	55 bar
45°	•	4512	2.5	3.5	4.9	7.5	12.6	21
	•	4516	2.8	4.5	6.3	9.7	16.4	27
	•	4520	3.0	5.5	7.8	11.9	20	33
	•	4525	3.5	7.2	10.1	15.5	26	43
	•	4531	4.0	8.8	12.4	18.9	32	53
	•	4540	4.5	11.3	15.9	24	41	68
	•	4549	5.0	13.7	19.4	30	50	83
	•	4578	6.0	22	31	48	81	135
	•	4599	7.0	28	39	60	101	167
	•	45124	8.0	35	49	75	126	210
30°	•	3002	1.0	.64	.91	1.4	2.3	3.9
	•	3003	1.2	.92	1.3	2.0	3.4	5.6
	•	3004	1.5	1.2	1.7	2.6	4.4	7.3
	•	3006	1.8	1.7	2.4	3.7	6.2	10.3
	•	3008	2.0	2.2	3.1	4.8	8.1	13.4
	•	3010	2.2	2.8	4.0	6.2	10.4	17.2
	•	3012	2.5	3.5	4.9	7.5	12.6	21
	•	3016	2.8	4.5	6.3	9.7	16.4	27
	•	3020	3.0	5.5	7.8	11.9	20	33
	•	3025	3.5	7.2	10.1	15.5	26	43
	•	3031	4.0	8.8	12.4	18.9	32	53
	•	3040	4.5	11.3	15.9	24	41	68
	•	3049	5.0	13.7	19.4	30	50	83
	•	3078	6.0	22	31	48	81	135
•	3099	7.0	28	39	60	101	167	
•	30124	8.0	35	49	75	126	210	
15°	•	1502	1.0	.64	.91	1.4	2.3	3.9
	•	1503	1.2	.92	1.3	2.0	3.4	5.6
	•	1504	1.5	1.2	1.7	2.6	4.4	7.3
	•	1506	1.8	1.7	2.4	3.7	6.2	10.3
	•	1508	2.0	2.2	3.1	4.8	8.1	13.4
	•	1510	2.2	2.8	4.0	6.2	10.4	17.2
	•	1512	2.5	3.5	4.9	7.5	12.6	21
	•	1516	2.8	4.5	6.3	9.7	16.4	27
	•	1520	3.0	5.5	7.8	11.9	20	33
	•	1525	3.5	7.2	10.1	15.5	26	43
	•	1531	4.0	8.8	12.4	18.9	32	53
	•	1540	4.5	11.3	15.9	24	41	68

Highlighted column shows the rated pressure.



**PERFORMANCE DATA
FLAT SPRAY: 27149**

Spray Angle at 4.0 bar	Nozzle Type	Capacity Size	Equiv. Orifice Dia. (mm)	Flow Rate Capacity (liters per minute)				
	27149			1.5 bar	3.0 bar	7.0 bar	20 bar	55 bar
15°	•	1549	5.0	13.7	19.4	30	50	83
	•	1578	6.0	22	31	48	81	135
	•	1599	7.0	28	39	60	101	167
	•	15124	8.0	35	49	75	126	210
0° (solid stream)	•	00004	.3	.11	.16	.24	.41	.68
	•	00007	.4	.20	.28	.42	.71	1.2
	•	00009	.5	.25	.36	.54	.92	1.5
	•	0001	.6	.36	.51	.78	1.3	2.2
	•	00015	.89	.40	.57	.90	1.4	2.5
	•	0002	1.0	.64	.91	1.4	2.3	3.9
	•	0003	1.2	.92	1.3	2.0	3.4	5.6
	•	0004	1.5	1.2	1.7	2.6	4.4	7.3
	•	0006	1.8	1.7	2.4	3.7	6.2	10.3
	•	0008	1.9	2.2	3.1	4.8	8.1	13.4
	•	0010	2.2	2.8	4.0	6.2	10.4	17.2
	•	0012	2.4	3.5	4.9	7.5	12.6	21
	•	0020	3.2	5.5	7.8	11.9	20	33

Highlighted column shows the rated pressure.

**PERFORMANCE DATA
SOLID STREAM SPRAY: 39350, 48546, 50790, 39485**

Spray Angle at 40 bar	Capacity Size	Equiv. Orifice Dia. (mm)	Flow Rate Capacity (liters per minute)				
			1.5 bar	3.0 bar	7.0 bar	20 bar	55 bar
0° (solid stream)	00003	.38	.08	.12	.18	.31	.49
	00005	.51	.14	.20	.30	.51	.85
	00008	.64	.23	.32	.48	.82	1.4
	00011	.76	.39	.55	.84	1.40	2.4
	00015	.89	.50	.71	1.09	1.80	3.1
	00020	1.02	.64	.91	1.40	2.30	3.9
	00025	1.14	.78	1.11	1.70	2.85	4.8

Highlighted column shows the rated pressure.

DIMENSIONS

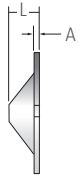
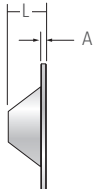
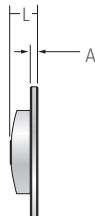
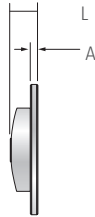
Nozzle	Nozzle Type	L (mm)	D (Dia.) (mm)	Thickness A (mm)
	27149	7.1 (max)	26.6	1.1
	39350 and 48546	8.1	25.9	1.1
	50790	5.6	26.4	1.5
	50790-1	5.6	26.6	1.5
	39485	5.6	26.6	1.5

All ShowerJet nozzles are installed with a standard gasket which is included, CP28624-001.

ORDERING INFORMATION

Call your local spray expert for application assistance or to place an order.

PERFORMANCE DATA
SOLID STREAM: 48460, 19124, P36503, 56740, 48277, 21280, 39458, 22812, 20094

Capacity Size	Equiv. Orifice Dia. (mm)	Flow Rate Capacity (liters per minute)								
		3.0 bar	4.0 bar	5.0 bar	7.0 bar	15.0 bar	30 bar	40 bar	50 bar	60 bar
14	.36	.12	.13	.15	.17	.25	.37	.42	.47	.51
28	.71	.42	.48	.54	.63	.93	1.3	1.5	1.7	1.9
33	.84	.62	.73	.81	.95	1.4	2.0	2.4	2.7	2.9
40	1.02	.89	1.0	1.1	1.4	2.0	2.8	3.2	3.6	3.9
55	1.4	1.6	1.9	2.1	2.4	3.6	5.0	5.8	6.5	7.0
70	1.78	2.7	3.1	3.5	4.2	6.1	8.8	10.0	11.0	13.0
94	2.39	4.5	5.2	5.9	7.0	10.0	15.0	18.0	20	22
125	3.18	7.3	8.5	9.6	11.0	17.0	25	30	33	37

ORDERING INFORMATION

Call your local spray expert for application assistance or to place an order.

METRIC UNITS

DIMENSIONS

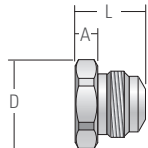
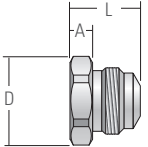
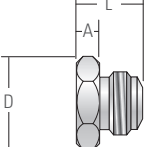
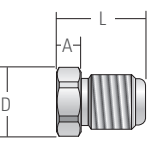
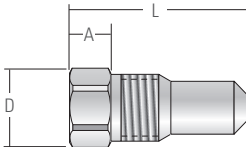
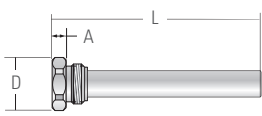
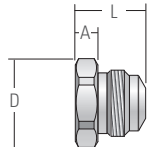
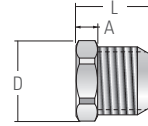
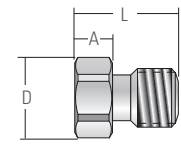
Nozzle	Nozzle Type	Conn. Thread Size (in.)	L (mm)	A (mm)	Hex. (mm)	D (Dia.) (mm)
	48460	9/16"-24 NEF	14.1	4.0	17.5	19.1
	19124	9/16"-24 NEF	14.1	4.9	6.4	19.1
	P36503	1/4 BSPP	14.1	4.9	17.5	19.1
	56740	1/8 BSPP	16.8	4.3	11.1	12.3
	48277	1/8	28.6	6.4	11.1	12.3
	21280	9/16"-24 NEF	Varies	4.9	17.5	19.1
	39458	9/16"-24 NEF	Varies	4.9	17.5	19.1
	22812	1/8	11.2	3.3	11.1	12.3
	20094	1/4"-28 UNF	11.2	4.1	7.9	8.7

**PERFORMANCE DATA
SOLID STREAM SPRAY: DK, DJ, 48284, 25834**

Spray Angle at 3.0 bar	Nozzle Type				Capacity Size	Equiv. Orifice Dia. (mm)	Flow Rate Capacity (liters per minute)								
	DK	DJ	25834	48284			1.0 bar	2.0 bar	3.0 bar	4.0 bar	5.0 bar	6.0 bar	7.0 bar	10.0 bar	
110°		•			11006	–	1.4	1.9	2.4	2.7	3.1	3.3	3.6	4.3	
95°		•			9504	–	.91	1.3	1.6	1.8	2	2.2	2.4	2.9	
90°	•	•			9001	–	.23	.32	.39	.46	.51	.56	.6	.72	
	•	•			90016	.79	.36	.52	.63	.73	.82	.89	.96	1.2	
	•	•			90026	–	.59	.84	1.03	1.2	1.33	1.5	1.6	1.88	
	•	•			90054	1.6	1.2	1.7	2.1	2.5	2.8	3.0	3.3	3.9	
	•	•			9013	2.4	3.0	4.2	5.1	5.9	6.6	7.3	7.8	9.4	
	•	•			9024	3.2	5.5	7.7	9.5	10.9	12.2	13.4	14.5	17.3	
80°	•	•			80032	1.2	.73	1.0	1.3	1.5	1.6	1.8	1.9	2.3	
	•	•			80054	1.6	1.2	1.7	2.1	2.5	2.8	3.0	3.3	3.9	
	•	•			8008	1.9	1.8	2.6	3.2	3.6	4.1	4.5	4.8	5.8	
	•	•			80084	1.9	1.9	2.7	3.3	3.8	4.3	4.7	5.1	6.1	
	•	•			8013	2.4	3.0	4.2	5.1	5.9	6.6	7.3	7.8	9.4	
	•	•			8024	3.2	5.5	7.7	9.5	10.9	12.2	13.4	14.5	17.3	
	•	•			8033	4.0	7.5	10.6	13.0	15.0	16.8	18.4	19.9	24	
	•	•			8035	–	8.0	11.3	13.8	16.0	17.9	19.6	21.1	25.2	
70°	•	•			8054	4.7	12.3	17.4	21.3	25	28	30.2	33	39	
	•	•			70023	1.0	.52	.74	.91	1.0	1.2	1.3	1.4	1.5	
	•	•			6824	3.2	5.5	7.7	9.5	10.9	12.2	13.4	14.5	17.3	
	•	•			6840	–	9.1	12.9	15.8	18.2	20	22	24	29	
	•	•			6870	5.5	16.0	23	28	32	36	39	42	50	
	65°	•	•			650050	–	.11	.16	.2	.23	.25	.28	.3	.36
		•	•			65054	1.6	1.2	1.7	2.1	2.5	2.8	3.0	3.3	3.9
		•	•			6513	2.4	3.0	4.2	5.1	5.9	6.6	7.3	7.8	9.4
•		•			6519	2.8	4.3	6.1	7.5	8.7	9.7	10.6	11.5	13.7	
•		•			6533	4.0	7.5	10.6	13.0	15.0	16.8	18.4	19.9	24	
•		•			6550	4.7	11.4	16.1	19.7	23	25	28	30	36	
•		•			6570	5.5	16.0	23	28	32	36	39	42	50	
•		•			6585	–	19.4	27	34	39	43	47	51	61	
60°	•	•			60054	1.6	1.2	1.7	2.1	2.5	2.8	3.0	3.3	3.9	
	•	•			5824	3.2	5.5	7.7	9.5	10.9	12.2	13.4	14.5	17.3	
58°	•	•			5833	4.0	7.5	10.6	13.0	15.0	16.8	18.4	19.9	24	
	•	•			55054	1.6	1.2	1.7	2.1	2.5	2.8	3.0	3.3	3.9	
55°	•	•			5508	1.9	1.8	2.6	3.2	3.6	4.1	4.5	4.8	5.8	
	•	•			50033	1.2	.75	1.1	1.3	1.5	1.7	1.8	2.0	2.4	
50°	•	•			50084	–	1.9	2.7	3.3	3.8	4.3	4.7	5.1	6.1	
	•	•			5013	–	3.0	4.2	5.1	5.9	6.6	7.3	7.8	9.4	
	•	•			5024	3.2	5.5	7.7	9.5	10.9	12.2	13.4	14.5	17.3	
	•	•													

Highlighted column shows the rated pressure.





PERFORMANCE DATA
SOLID STREAM SPRAY: DK, DJ, 48284, 25834

Spray Angle at 3.0 bar	Nozzle Type				Capacity Size	Equiv. Orifice Dia. (mm)	Flow Rate Capacity (liters per minute)							
	DK	DJ	25834	48284			1.0 bar	2.0 bar	3.0 bar	4.0 bar	5.0 bar	6.0 bar	7.0 bar	10.0 bar
50°	•	•			5033	4.0	7.5	10.6	13.0	15.0	16.8	18.4	19.9	24
	•	•			5037	—	8.4	11.9	14.6	16.9	18.9	21	22	27
	•	•			5040	—	9.1	12.9	15.8	18.2	20	22	24	29
	•	•			5050	—	11.4	16.1	19.7	23	25	28	30	36
43°	•	•			4308	1.9	1.8	2.6	3.2	3.6	4.1	4.5	4.8	5.8
	•	•			4313	2.4	3	4.2	5.1	5.9	6.6	7.3	7.8	9.4
40°	•	•			4024	—	5.5	7.7	9.5	10.9	12.2	13.4	14.5	17.3
	•	•			4047	4.7	10.7	15.1	18.6	21	24	26	28	34
	•	•			4070	5.5	16.0	23	28	32	36	39	42	50
	•	•			4085	6.4	19.4	27	34	39	43	47	51	61
	•	•			4086	—	19.6	28	34	39.2	44	48	52	62
35°	•	•			3513	—	3.0	4.2	5.1	5.9	6.6	7.3	7.8	9.4
	•	•			3580	6.4	18.2	26	32	36	41	45	48	58
25°	•	•			2510	—	2.3	3.2	3.9	4.6	5.1	5.6	6	7.2
	•	•			2524	3.2	5.5	7.7	9.5	10.9	12.2	13.4	14.5	17.3
0° (solid stream)	•	•	•	•	00012	.025	.27	.39	.47	.55	.61	.67	.72	.86
	•	•	•	•	00015	.031	.34	.48	.59	.68	.76	.83	.90	1.08
	•	•	•	•	00016	.034	.37	.52	.63	.73	.82	.89	1.0	1.2
	•	•	•	•	00023	.040	.50	.70	.90	1.1	1.2	1.3	1.4	1.6
	•	•	•	•	00051	.060	1.2	1.6	2.0	2.3	2.6	2.9	3.1	3.7
	•	•	•	•	0006	.065	1.4	1.9	2.4	2.8	3.1	3.4	3.6	4.3
	•	•	•	•	0008	.070	1.8	2.6	3.2	3.7	4.1	4.5	4.8	5.8
	•	•	•	•	0024	.125	5.5	7.5	9.5	10.5	12.2	13.4	14.5	17.3
	•	•	•	•	0033	.156	7.5	10.5	13.0	15.0	16.8	18.4	19.9	24
	•	•			All others									

Highlighted column shows the rated pressure.

DIMENSIONS

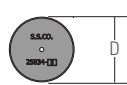
Nozzle	Nozzle Type	Conn. Thread Size (in.)	D (Dia.) (mm)	Thickness (mm)
	DK	—	14.73	3.2
	DJ	5/8"-18	15.87	3.2
	48284	—	14.83	3.2
	25834	—	16	2.41

PERFORMANCE DATA
FLAT AND SOLID STREAM SPRAY: 20210, 20235, 26225, 26411, 36090,
38332, 38490, 49905, 72370

Spray Angle at 2.8 bar	Capacity Size	Flow Rate Capacity (liters per minute)													
		1.5 bar	2.0 bar	2.5 bar	3.0 bar	3.5 bar	4.0 bar	4.5 bar	5.0 bar	5.5 bar	6.0 bar	7.0 bar	8.0 bar	10.0 bar	15.0 bar
130°	13016	4.5	5.2	5.8	6.3	6.8	7.3	7.7	8.2	8.6	8.9	9.6	10.3	11.5	14.1
120°	12008	2.2	2.6	2.9	3.2	3.4	3.6	3.9	4.1	4.3	4.5	4.8	5.2	5.8	7.1
100°	10011	3.1	3.5	4.0	4.3	4.7	5.0	5.3	5.6	5.9	6.1	6.6	7.1	7.9	9.7
	10020	5.6	6.4	7.2	7.9	8.5	9.1	9.7	10.2	10.7	11.2	12.1	12.9	14.4	17.7
80°	8003	.84	.97	1.1	1.2	1.3	1.4	1.45	1.5	1.6	1.7	1.8	1.9	2.2	2.6
	8005	1.4	1.6	1.8	2.0	2.1	2.3	2.4	2.5	2.7	2.8	3.0	3.2	3.6	4.4
	8011	3.1	3.5	4.0	4.3	4.7	5.0	5.3	5.6	5.9	6.1	6.6	7.1	7.9	9.7
	8019	5.3	6.1	6.8	7.5	8.1	8.7	9.2	9.7	10.2	10.6	11.5	12.2	13.7	16.8
	8030	8.4	9.7	10.8	11.8	12.8	13.7	14.5	15.3	16.0	16.7	18.1	19.3	22	26
	8036	10.0	11.6	13.0	14.2	15.3	16.4	17.4	18.3	19.2	20	22	23	26	32
	8046	12.8	14.8	16.6	18.2	19.6	21	22	23	25	26	28	30	33	41
60°	6005	1.4	1.6	1.8	2.0	2.1	2.3	2.4	2.5	2.7	2.8	3.0	3.2	3.6	4.4
	6012	3.3	3.9	4.3	4.7	5.1	5.5	5.8	6.1	6.4	6.7	7.2	7.7	8.6	10.6
	6014	3.9	4.5	5.0	5.5	6.0	6.4	6.8	7.1	7.5	7.8	8.4	9.0	10.1	12.4
	6016	4.5	5.2	5.8	6.3	6.8	7.3	7.7	8.2	8.6	8.9	9.6	10.3	11.5	14.1
	6020	5.6	6.4	7.2	7.9	8.5	9.1	9.7	10.2	10.7	11.2	12.1	12.9	14.4	17.7
	6025	7.0	8.1	9.0	9.9	10.7	11.4	12.1	12.7	13.4	14.0	15.1	16.1	18.0	22
	6031	8.7	10.0	11.2	12.2	13.2	14.1	15.0	15.8	16.6	17.3	18.7	20	22	27
	6038	10.6	12.2	13.7	15	16.2	17.3	18.4	19.4	20	21	23	24	27	34
	6050	13.2	16.3	18.9	19.7	23	23	27	25	30	28	36	40	42	48
50°	5032	8.9	10.3	11.5	12.6	13.6	14.6	15.5	16.3	17.1	17.9	19.3	21	23	28
45°	4516	4.5	5.2	5.8	6.3	6.8	7.3	7.7	8.2	8.6	8.9	9.6	10.3	11.5	14.1
	4525	7.0	8.1	9.0	9.9	10.7	11.4	12.1	12.7	13.4	14.0	15.1	16.1	18.0	22
	4542	11.7	13.5	15.1	16.6	17.9	19.1	20	21	22	23	25	27	30	37
40°	4008	2.2	2.6	2.9	3.2	3.4	3.6	3.9	4.1	4.3	4.5	4.8	5.2	5.8	7.1
	4012	3.3	3.9	4.3	4.7	5.1	5.5	5.8	6.1	6.4	6.7	7.2	7.7	8.6	10.6
	4013	3.6	4.2	4.7	5.1	5.5	5.9	6.3	6.6	6.9	7.3	7.8	8.4	9.4	11.5
	4014	3.9	4.5	5.0	5.5	6.0	6.4	6.8	7.1	7.5	7.8	8.4	9.0	10.1	12.4
	4020	5.6	6.4	7.2	7.9	8.5	9.1	9.7	10.2	10.7	11.2	12.1	12.9	14.4	17.7
	4032	8.9	10.3	11.5	12.6	13.6	14.6	15.5	16.3	17.1	17.9	19.3	21	23	28
	4045	12.6	14.5	16.2	17.8	19.2	21	22	23	24	25	27	29	32	40
30°	3005	1.4	1.6	1.8	2.0	2.1	2.3	2.4	2.5	2.7	2.8	3.0	3.2	3.6	4.4
	3013	3.6	4.2	4.7	5.1	5.5	5.9	6.3	6.6	6.9	7.3	7.8	8.4	9.4	11.5
	3014	3.9	4.5	5.0	5.5	6.0	6.4	6.8	7.1	7.5	7.8	8.4	9.0	10.1	12.4
	3040	11.2	12.9	14.4	15.8	17.1	18.2	19.3	20	21	22	24	26	29	35

Highlighted column shows the rated pressure.



PERFORMANCE DATA

FLAT AND SOLID STREAM SPRAY: 20210, 20235, 26225, 26411, 36090, 38332, 38490, 49905, 72370

Spray Angle at 2.8 bar	Capacity Size	Flow Rate Capacity (liters per minute)													
		1.5 bar	2.0 bar	2.5 bar	3.0 bar	3.5 bar	4.0 bar	4.5 bar	5.0 bar	5.5 bar	6.0 bar	7.0 bar	8.0 bar	10.0 bar	15.0 bar
20°	2012	3.3	3.9	4.3	4.7	5.1	5.5	5.8	6.1	6.4	6.7	7.2	7.7	8.6	10.6
15°	1506	1.7	1.9	2.2	2.4	2.6	2.7	2.9	3.1	3.2	3.3	3.6	3.9	4.3	5.3
0° (solid stream)	000012	.03	.04	.04	.05	.05	.06	.06	.06	.06	.07	.07	.08	.09	.11
	000026	.07	.08	.09	.1	.11	.12	.125	.13	.14	.15	.16	.17	.19	.23
	000053	.15	.17	.19	.21	.23	.24	.26	.27	.28	.3	.32	.34	.38	.47
	00007	.2	.23	.25	.28	.3	.32	.34	.36	.37	.39	.42	.45	.5	.62
	0001	.28	.32	.36	.39	.43	.46	.48	.51	.53	.56	.6	.64	.72	.88
	00017	.47	.55	.61	.67	.72	.77	.82	.87	.91	.95	1.0	1.1	1.2	1.5
	0002	.56	.64	.72	.79	.85	.91	.97	1.0	1.07	1.1	1.2	1.3	1.4	1.8
	00025	.7	.81	.9	.99	1.0	1.1	1.2	1.3	1.34	1.4	1.5	1.6	1.8	2.2
	00032	.89	1.0	1.2	1.3	1.4	1.5	1.55	1.6	1.7	1.8	1.9	2.1	2.3	2.8
	00043	1.2	1.4	1.5	1.7	1.8	2.0	2.1	2.2	2.3	2.4	2.6	2.8	3.1	3.8
	0005	1.4	1.6	1.8	2.0	2.1	2.3	2.4	2.5	2.7	2.8	3.0	3.2	3.6	4.4
	0006	1.7	1.9	2.2	2.4	2.6	2.7	2.9	3.1	3.2	3.3	3.6	3.9	4.3	5.3
0008	2.2	2.6	2.9	3.2	3.4	3.6	3.9	4.1	4.3	4.5	4.8	5.2	5.8	7.1	
0010	2.8	3.2	3.6	3.9	4.3	4.6	4.8	5.1	5.3	5.6	6.0	6.4	7.2	8.8	

Highlighted column shows the rated pressure.

ORDERING INFORMATION

Call your local spray expert for application assistance or to place an order.

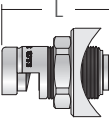
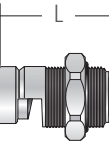
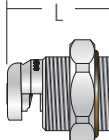
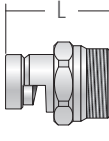
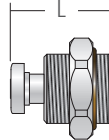

DIMENSIONS

Nozzle	Nozzle Type	Conn. Thread Size (in.)	Length (mm)	D (Dia.) (mm)	Hex. (mm)
	20210	1-1/8"-20 UN	41.4	42.2	38.1
	20235	3/4"-20 UNEF	35.6	31.8	25.4
	26225	3/4"-20 UNEF	35.6	27.7	25.4
	26411	3/4" BSPP	35.6	42.2	38.1
	36090	M28 x 1.5	41.4	42.2	38.1
	38332	3/4"	39.1	29.7	27.0
	38490	1-1/8"-20 UN	41.4	42.2	38.1

METRIC UNITS



METRIC UNITS

DIMENSIONS

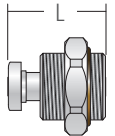
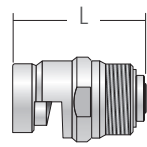
Nozzle	Nozzle Type	Conn. Thread Size (in.)	Length (mm)	D (Dia.) (mm)	Hex. (mm)
	49905	1-1/8"-20 UN	41.4	42.2	38.1
	49905-1	M28" x 1.5	41.4	42.2	38.1
	72370	1/2"	35.3	22.2	20.9 flats

ORDERING INFORMATION

Call your local spray expert for application assistance or to place an order.

PERFORMANCE DATA
SOLID STREAM SPRAY: 38170, 38171, 48461, 72242, 39610

Nozzle Type/ Conn. Size (in.)					Capacity Size	Equiv. Orifice Dia. (mm)	Capacity (liters per minute)					
38170	38171	48461	72242	39610			7 bar	10 bar	30 bar	50 bar	60 bar	70 bar
3/8	1/8	1/8	1/8	M10								
				•	10	.25	.07	.09	.15	.19	.21	.22
•	•	•	•	•	15	.38	.17	.21	.36	.46	.50	.54
•	•	•	•	•	20	.51	.31	.36	.63	.82	.89	.96
•	•	•	•	•	25	.64	.48	.57	.99	1.3	1.4	1.5
				•	27.5	.69	.57	.67	1.1	1.5	1.6	1.7
•	•	•	•	•	30	.76	.69	.82	1.4	1.8	2.0	2.2
				•	32	.81	.78	.92	1.5	2.0	2.2	2.3
•	•	•	•	•	35	.89	.93	1.1	1.9	2.5	2.7	3.0
•	•	•	•	•	40	1.0	1.2	1.5	2.5	3.3	3.6	3.9
•	•	•	•	•	45	1.1	1.5	1.9	3.2	4.1	4.5	4.9
•	•				50	1.3	1.9	2.3	4.0	5.1	5.6	6.0
•	•				60	1.5	2.8	3.3	5.7	7.3	8.0	8.7

48461 and 72242 are only available with ruby orifice.

PERFORMANCE DATA
SOLID STREAM SPRAY: 58035-2, 56795-2

Conn. Size (in.)	Nozzle Type		Capacity Size	Equiv. Orifice Dia. (mm)	Flow Rate Capacity (liters per minute)					
	58035-2	56795-2			7 bar	10 bar	20 bar	30 bar	50 bar	70 bar
1/8	•	•	10	.25	.15	.18	.25	.31	.39	.46
	•	•	15	.38	.35	.41	.59	.72	.93	1.1
	•	•	20	.51	.62	.74	1.1	1.3	1.7	2.0
	•	•	25	.64	.92	1.1	1.5	1.9	2.5	2.9
	•	•	30	.76	1.4	1.6	2.3	2.8	3.7	4.3
	•	•	35	.89	1.8	2.2	3.1	3.8	4.9	5.8

DIMENSIONS AND WEIGHTS

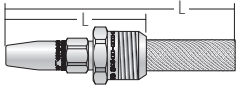
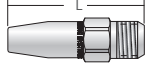
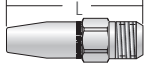
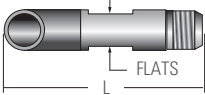
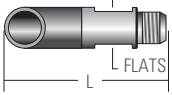
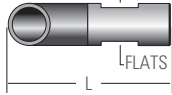
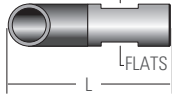
Nozzle	Nozzle Type	Conn. Size/Type (in.)	L (mm)	D (Dia.) (mm)	Hex./Flats (mm)
	38170	3/8 male	39.0 with strainer 85.9	21.0	19.1
	38171	1/8 male	39.0	12.2	11.0
	48461	1/8 male	39.0	12.2	11.0
	72242	1/8 male	53.2	10.7	8.4
	39610	M10 x 0.75 male	62.2	14.0	10.2
	56795-2	1/8 male/female	53.1	13.4	10.8
	58035-2	1/8 male/female	51.3	13.4	10.8

ADAPTER DIMENSIONS AND WEIGHTS

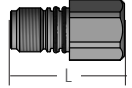
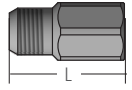
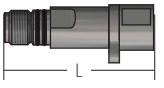
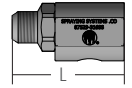
Nozzle	Nozzle Type	Conn. Size/Type (in.)	Outlet Conn. (in.)	L (mm)	D (Dia.) (mm)	Hex./Flats (mm)
	115425	M10	1/8 female	26.0	–	12.7
	115427	1/8 male	M10 female	25.4	–	12.7
	39290	M10 x 0.75 male	1/8 female	43.5	13.2	10.0, 12.0 Flats
	87529	1/8, 1/4 M10 x 0.75	1/8, 1/4 M10 x 0.75	49.0	0.98 25.0	21.0 Flats 19.0 Hex

**PERFORMANCE DATA
STANDARD ANGLE SPRAY: H-VV, H-VVL AND H-DT**

Spray Angle at 3 bar	Nozzle Type/ Conn. Size (in.)						Capacity Size	Equiv. Orifice Dia. (mm)	Flow Rate Capacity (liters per minute)								Spray Angle (°)				
	H-VV		H-VVL		H-DT				0.4 bar	0.7 bar	1.5 bar	3 bar	6 bar	7 bar	15 bar	20 bar	35 bar	1.5 bar	3 bar	6 bar	15 bar
	1/8	1/4	1/8	1/4	1/8	1/4															
110°	•	•	•	•			01	.66	.14	.19	.28	.39	.56	.60	.88	1.0	1.3	94	110	121	124
	•	•	•	•			015	.81	.22	.29	.42	.59	.84	.90	1.3	1.5	2.0	97	110	121	124
	•	•	•	•		•	02	.89	.29	.38	.56	.79	1.1	1.2	1.8	2.0	2.7	98	110	120	123
	•	•	•	•		•	03	1.1	.43	.57	.84	1.2	1.7	1.8	2.6	3.1	4.0	99	110	120	123
	•	•	•	•	•	•	04	1.3	.58	.76	1.1	1.6	2.2	2.4	3.5	4.1	5.4	100	110	119	122
	•	•	•	•		•	05	1.4	.72	.95	1.4	2.0	2.8	3.0	4.4	5.1	6.7	100	110	118	122
	•	•	•	•	•	•	06	1.5	.86	1.1	1.7	2.4	3.4	3.6	5.3	6.1	8.1	101	110	117	122
	•	•	•	•		•	08	1.8	1.2	1.5	2.2	3.2	4.5	4.8	7.1	8.2	10.8	102	110	117	121
	•	•	•	•	•	•	10	2.0	1.4	1.9	2.8	3.9	5.6	6.0	8.8	10.2	13.5	103	110	117	119
	•	•	•	•		•	15	2.4	2.2	2.9	4.2	5.9	8.4	9.0	13.2	15.3	20	104	110	117	118
95°	•		•		•		0050	.46	–	–	.14	.20	.28	.30	.44	.51	.67	81	95	105	113
	•	•	•	•			01	.66	.14	.19	.28	.39	.56	.60	.88	1.0	1.3	81	95	105	113
	•		•	•			015	.81	.22	.29	.42	.59	.84	.90	1.3	1.5	2.0	82	95	105	113
	•	•	•	•	•	•	02	.89	.29	.38	.56	.79	1.1	1.2	1.8	2.0	2.7	82	95	105	113
	•	•	•	•		•	03	1.1	.43	.57	.84	1.2	1.7	1.8	2.6	3.1	4.0	83	95	104	111
	•	•	•	•	•	•	04	1.3	.58	.76	1.1	1.6	2.2	2.4	3.5	4.1	5.4	84	95	103	108
	•	•	•	•	•		05	1.4	.72	.95	1.4	2.0	2.8	3.0	4.4	5.1	6.7	84	95	102	107
	•	•	•	•	•	•	06	1.5	.86	1.1	1.7	2.4	3.4	3.6	5.3	6.1	8.1	86	95	101	106
	•				•		065	1.6	.94	1.2	1.8	2.6	3.6	3.9	5.7	6.6	8.8	86	95	101	106
•	•	•	•	•	•	08	1.8	1.2	1.5	2.2	3.2	4.5	4.8	7.1	8.2	10.8	87	95	100	105	
80°	•	•	•	•			0050	.46	–	–	.14	.20	.28	.30	.44	.51	.67	61	80	95	101
	•	•	•	•			0067	.53	–	.13	.19	.26	.37	.40	.59	.68	.90	67	80	94	99
	•	•	•	•	•	•	01	.66	–	.19	.28	.39	.56	.60	.88	1.0	1.3	68	80	89	92
		•	•	•		•	015	.81	–	.29	.42	.59	.84	.90	1.3	1.5	2.0	68	80	89	92
	•	•	•	•	•	•	02	.89	.29	.38	.56	.79	1.1	1.2	1.8	2.0	2.7	69	80	88	91
	•	•	•	•	•	•	03	1.1	.43	.57	.84	1.2	1.7	1.8	2.6	3.1	4.0	70	80	87	90
	•	•	•	•	•	•	04	1.3	.58	.76	1.1	1.6	2.2	2.4	3.5	4.1	5.4	71	80	86	89
	•	•	•	•	•	•	05	1.4	.72	.95	1.4	2.0	2.8	3.0	4.4	5.1	6.7	71	80	86	89
	•	•	•	•	•	•	06	1.5	.86	1.1	1.7	2.4	3.4	3.6	5.3	6.1	8.1	72	80	85	88
	•				•	•	07	1.7	1.0	1.3	2.0	2.8	3.9	4.2	6.2	7.1	9.4	72	80	85	88
	•	•	•	•	•	•	08	1.8	1.2	1.5	2.2	3.2	4.5	4.8	7.1	8.2	10.8	72	80	84	87
	•	•	•	•	•	09	1.9	1.3	1.7	2.5	3.6	5.0	5.4	7.9	9.2	12.1	73	80	84	87	

Highlighted column shows the rated pressure.



PERFORMANCE DATA
STANDARD ANGLE SPRAY: H-VV, H-VVL AND H-DT

Spray Angle at 3 bar	Nozzle Type/ Conn. Size (in.)						Capacity Size	Equiv. Orifice Dia. (mm)	Flow Rate Capacity (liters per minute)										Spray Angle (°)			
	H-VV		H-VVL		H-DT				0.4 bar	0.7 bar	1.5 bar	3 bar	6 bar	7 bar	15 bar	20 bar	35 bar	1.5 bar	3 bar	6 bar	15 bar	
	1/8	1/4	1/8	1/4	1/8	1/4																
73°	•	•	•	•	•		0077	.58	–	.15	.21	.30	.43	.46	.68	.78	1.0	53	73	86	92	
	•	•	•	•			0154	.81	.22	.29	.43	.61	.86	.93	1.4	1.6	2.1	55	73	84	88	
		•		•			0231	.97	.33	.44	.64	.91	1.3	1.4	2.0	2.4	3.1	56	73	83	87	
	•	•	•	•			0308	1.2	.44	.59	.86	1.2	1.7	1.9	2.7	3.1	4.2	58	73	82	86	
		•		•			0462	1.4	.67	.88	1.3	1.8	2.6	2.8	4.1	4.7	6.2	60	73	80	84	
	•		•				0770	1.8	1.1	1.5	2.1	3.0	4.3	4.6	6.8	7.8	10.4	64	73	77	82	
65°	•		•				0017	.28	–	–	.047	.067	.095	.10	.15	.17	.23	44	65	77	86	
	•		•				0033	.38	–	–	.092	.13	.18	.20	.29	.34	.45	47	65	76	83	
	•	•	•	•	•		0067	.53	–	.13	.19	.26	.37	.40	.59	.68	.90	50	65	75	81	
	•	•	•	•	•	•	01	.66	–	.19	.28	.39	.56	.60	.88	1.0	1.3	51	65	74	80	
	•	•	•	•			015	.81	–	.29	.42	.59	.84	.90	1.3	1.5	2.0	51	65	74	80	
	•	•	•	•	•	•	02	.89	.29	.38	.56	.79	1.1	1.2	1.8	2.0	2.7	52	65	73	79	
	•		•				025	.99	.36	.48	.70	.99	1.4	1.5	2.2	2.5	3.4	52	65	73	79	
	•	•	•	•	•	•	03	1.1	.43	.57	.84	1.2	1.7	1.8	2.6	3.1	4.0	53	65	72	78	
	•	•	•	•	•	•	04	1.3	.58	.76	1.1	1.6	2.2	2.4	3.5	4.1	5.4	53	65	72	76	
	•	•	•	•	•	•	05	1.4	.72	.95	1.4	2.0	2.8	3.0	4.4	5.1	6.7	53	65	72	76	
		•			•	•	055	1.5	.79	1.0	1.5	2.2	3.1	3.3	4.9	5.6	7.4	53	65	72	76	
	•	•		•	•	•	06	1.5	.86	1.1	1.7	2.4	3.4	3.6	5.3	6.1	8.1	54	65	72	75	
		•			•	•	07	1.7	1.0	1.3	2.0	2.8	3.9	4.2	6.2	7.1	9.4	54	65	71	75	
	•	•	•	•	•	•	08	1.8	1.2	1.5	2.2	3.2	4.5	4.8	7.1	8.2	10.8	55	65	71	74	
•				•	•	09	1.9	1.3	1.7	2.5	3.6	5.0	5.4	7.9	9.2	12.1	55	65	71	74		
50°	•	•	•	•			01	.66	–	.19	.28	.39	.56	.60	.88	1.0	1.3	37	50	59	65	
	•	•	•	•			02	.89	–	.38	.56	.79	1.1	1.2	1.8	2.0	2.7	39	50	57	63	
	•	•	•	•		•	03	1.1	.43	.57	.84	1.2	1.7	1.8	2.6	3.1	4.0	40	50	56	62	
	•	•	•	•		•	04	1.3	.58	.76	1.1	1.6	2.2	2.4	3.5	4.1	5.4	42	50	56	61	
	•	•	•	•		•	05	1.4	.72	.95	1.4	2.0	2.8	3.0	4.4	5.1	6.7	44	50	56	61	
	•					•	055	1.5	.79	1.0	1.5	2.2	3.1	3.3	4.9	5.6	7.4	44	50	56	61	
	•	•	•	•		•	06	1.5	.86	1.1	1.7	2.4	3.4	3.6	5.3	6.1	8.1	45	50	56	60	
	•	•				•	07	1.7	1.0	1.3	2.0	2.8	3.9	4.2	6.2	7.1	9.4	45	50	56	60	
	•	•	•	•		•	08	1.8	1.2	1.5	2.2	3.2	4.5	4.8	7.1	8.2	10.8	45	50	55	60	
		•			•	•	09	1.9	1.3	1.7	2.5	3.6	5.0	5.4	7.9	9.2	12.1	45	50	55	59	
40°	•	•	•	•	•		01	.66	–	–	.28	.39	.56	.60	.88	1.0	1.3	26	40	52	59	
	•	•	•	•	•		015	.81	–	–	.42	.59	.84	.90	1.3	1.5	2.0	27	40	52	59	
	•	•	•	•	•	•	02	.89	–	.38	.56	.79	1.1	1.2	1.8	2.0	2.7	29	40	51	58	
	•	•	•	•	•	•	03	1.1	–	.57	.84	1.2	1.7	1.8	2.6	3.1	4.0	30	40	50	57	
	•	•	•	•	•	•	04	1.3	–	.76	1.1	1.6	2.2	2.4	3.5	4.1	5.4	30	40	50	56	

Highlighted column shows the rated pressure.



**PERFORMANCE DATA
STANDARD ANGLE SPRAY: H-VV, H-VVL AND H-DT**

Spray Angle at 3 bar	Nozzle Type/ Conn. Size (in.)						Capacity Size	Equiv. Orifice Dia. (mm)	Flow Rate Capacity (liters per minute)										Spray Angle (°)			
	H-VV		H-VVL		H-DT				0.4 bar	0.7 bar	1.5 bar	3 bar	6 bar	7 bar	15 bar	20 bar	35 bar	1.5 bar	3 bar	6 bar	15 bar	
	1/8	1/4	1/8	1/4	1/8	1/4																
40°	•	•	•	•	•	•	05	1.4	–	.95	1.4	2.0	2.8	3.0	4.4	5.1	6.7	31	40	49	55	
	•	•			•	•	055	1.5	–	1.0	1.5	2.2	3.1	3.3	4.9	5.6	7.4	31	40	49	55	
	•	•	•	•	•	•	06	1.5	–	1.1	1.7	2.4	3.4	3.6	5.3	6.1	8.1	31	40	49	55	
	•	•			•	•	065	1.6	–	1.2	1.8	2.6	3.6	3.9	5.7	6.6	8.8	31	40	48	54	
	•	•			•	•	07	1.7	–	1.3	2.0	2.8	3.9	4.2	6.2	7.1	9.4	31	40	48	54	
	•	•	•	•	•	•	08	1.8	1.2	1.5	2.2	3.2	4.5	4.8	7.1	8.2	10.8	31	40	47	53	
	•						085	1.8	1.2	1.6	2.4	3.4	4.7	5.1	7.5	8.7	11.5	32	40	46	50	
	•	•			•	•	09	1.9	1.3	1.7	2.5	3.6	5.0	5.4	7.9	9.2	12.1	32	40	46	50	
25°	•	•	•	•	•		01	.66	–	–	.28	.39	.56	.60	.88	1.0	1.3	14	25	34	42	
	•	•	•	•	•	•	02	.89	–	–	.56	.79	1.1	1.2	1.8	2.0	2.7	15	25	33	40	
	•	•	•	•	•	•	03	1.1	–	–	.84	1.2	1.7	1.8	2.6	3.1	4.0	15	25	33	40	
	•	•	•	•	•	•	04	1.3	–	.76	1.1	1.6	2.2	2.4	3.5	4.1	5.4	16	25	32	39	
				•	•	•	045	1.3	–	.86	1.3	1.8	2.5	2.7	4.0	4.6	6.1	16	25	32	39	
	•	•	•	•	•	•	05	1.4	–	.95	1.4	2.0	2.8	3.0	4.4	5.1	6.7	16	25	32	39	
	•	•			•	•	055	1.5	–	1.0	1.5	2.2	3.1	3.3	4.9	5.6	7.4	16	25	31	38	
	•	•	•	•	•	•	06	1.5	–	1.1	1.7	2.4	3.4	3.6	5.3	6.1	8.1	17	25	31	38	
	•	•			•	•	065	1.6	–	1.2	1.8	2.6	3.6	3.9	5.7	6.6	8.8	17	25	31	38	
	•	•	•		•	•	07	1.7	–	1.3	2.0	2.8	3.9	4.2	6.2	7.1	9.4	17	25	31	38	
	•	•					075	1.7	–	1.4	2.1	3.0	4.2	4.5	6.6	7.6	10.1	17	25	31	38	
	•	•	•	•	•	•	08	1.8	–	1.5	2.2	3.2	4.5	4.8	7.1	8.2	10.8	17	25	31	38	
	•						085	1.8	–	1.6	2.4	3.4	4.7	5.1	7.5	8.7	11.5	18	25	31	37	
•	•			•	•	09	1.9	–	1.7	2.5	3.6	5.0	5.4	7.9	9.2	12.1	17	25	31	37		
				•		15	2.4	–	2.9	4.2	5.9	8.4	9.0	13.2	15.3	20	18	25	31	37		
15°	•	•		•			01	.66	–	–	–	.39	.56	.60	.88	1.0	1.3	–	15	24	28	
	•		•		•	•	02	.89	–	–	.56	.79	1.1	1.2	1.8	2.0	2.7	6	15	22	27	
	•	•	•	•	•	•	03	1.1	–	–	.84	1.2	1.7	1.8	2.6	3.1	4.0	6	15	22	27	
	•	•	•	•	•	•	04	1.3	–	–	1.1	1.6	2.2	2.4	3.5	4.1	5.4	7	15	21	26	
	•	•	•	•	•	•	05	1.4	–	–	1.4	2.0	2.8	3.0	4.4	5.1	6.7	7	15	21	26	
	•	•			•	•	055	1.5	–	1.0	1.5	2.2	3.1	3.3	4.9	5.6	7.4	7	15	21	26	
	•	•	•	•	•	•	06	1.5	–	1.1	1.7	2.4	3.4	3.6	5.3	6.1	8.1	8	15	21	26	
	•	•			•	•	065	1.6	–	1.2	1.8	2.6	3.6	3.9	5.7	6.6	8.8	8	15	20	25	
		•			•	•	07	1.7	–	1.3	2.0	2.8	3.9	4.2	6.2	7.1	9.4	8	15	20	25	
	•	•	•	•	•	•	08	1.8	–	1.5	2.2	3.2	4.5	4.8	7.1	8.2	10.8	9	15	20	25	
	•	•			•	•	085	1.8	–	1.6	2.4	3.4	4.7	5.1	7.5	8.7	11.5	9	15	19	24	
	•	•			•	•	09	1.9	–	1.7	2.5	3.6	5.0	5.4	7.9	9.2	12.1	9	15	19	24	

Highlighted column shows the rated pressure.



PERFORMANCE DATA
STANDARD ANGLE SPRAY: H-DU AND U

Spray Angle at 3 bar	Nozzle Type/ Conn. Size (in.)					Capacity Size	Equiv. Orifice Dia. (mm)	Flow Rate Capacity (liters per minute)										Spray Angle (°)			
	H-DU		U					0.4 bar	0.7 bar	1.5 bar	3 bar	6 bar	7 bar	15 bar	20 bar	35 bar	1.5 bar	3 bar	6 bar	15 bar	
	1/8	1/4	1	1-1/4	2																
95°	•	•				10	2.0	1.4	1.9	2.8	3.9	5.6	6.0	8.8	10.2	13.5	89	95	100	105	
	•	•				15	2.4	2.2	2.9	4.2	5.9	8.4	9.0	13.2	15.3	20	90	95	100	105	
		•				20	2.8	2.9	3.8	5.6	7.9	11.2	12.1	17.7	20	27	90	95	100	105	
	•	•				30	3.4	4.3	5.7	8.4	11.8	16.8	18.1	26	31	40	91	95	101	105	
		•				40	3.9	5.8	7.6	11.2	15.8	22	24	35	41	54	92	95	100	105	
		•				50	4.4	7.2	9.5	14.0	19.7	28	30	44	51	67	93	95	99	103	
		•				60	4.8	8.6	11.4	16.8	24	34	36	53	61	81	93	95	99	103	
80°		•				70	5.2	10.1	13.3	19.5	28	39	42	62	71	94	93	95	99	103	
	•	•				10	2.0	1.4	1.9	2.8	3.9	5.6	6.0	8.8	10.2	13.5	73	80	84	87	
	•	•				15	2.4	2.2	2.9	4.2	5.9	8.4	9.0	13.2	15.3	20	74	80	83	86	
	•	•				20	2.8	2.9	3.8	5.6	7.9	11.2	12.1	17.7	20	27	74	80	83	86	
	•	•				30	3.4	4.3	5.7	8.4	11.8	16.8	18.1	26	31	40	74	80	83	86	
	•	•				40	3.9	5.8	7.6	11.2	15.8	22	24	35	41	54	74	80	83	86	
		•				50	4.4	7.2	9.5	14.0	19.7	28	30	44	51	67	74	80	83	85	
		•				60	4.8	8.6	11.4	16.8	24	34	36	53	61	81	75	80	83	85	
		•				70	5.2	10.1	13.3	19.5	28	39	42	62	71	94	75	80	83	86	
65°			•			500	13.4	72	95	140	197	279	302	441	510	674	78	80	81	83	
			•			580	14.5	84	111	162	229	324	350	512	591	782	78	80	81	83	
	•	•				10	2.0	1.4	1.9	2.8	3.9	5.6	6.0	8.8	10.2	13.5	56	65	71	74	
	•	•				15	2.4	2.2	2.9	4.2	5.9	8.4	9.0	13.2	15.3	20	56	65	70	73	
	•	•				20	2.8	2.9	3.8	5.6	7.9	11.2	12.1	17.7	20	27	57	65	70	73	
	•	•				30	3.4	4.3	5.7	8.4	11.8	16.8	18.1	26	31	40	58	65	69	72	
	•	•				40	3.9	5.8	7.6	11.2	15.8	22	24	35	41	54	59	65	68	72	
		•				50	4.4	7.2	9.5	14.0	19.7	28	30	44	51	67	60	65	68	71	
		•				60	4.8	8.6	11.4	16.8	24	34	36	53	61	81	60	65	68	71	
	•	•				70	5.2	10.1	13.3	19.5	28	39	42	62	71	94	60	65	68	71	
50°			•	•		500	13.4	72	95	140	197	279	302	441	510	674	60	65	66	68	
			•			580	14.5	84	111	162	229	324	350	512	591	782	61	65	66	68	
	•					02	.89	.29	.38	.56	.79	1.1	1.2	1.8	2.0	2.7	39	50	57	63	
	•					03	1.1	.43	.57	.84	1.2	1.7	1.8	2.6	3.1	4.0	40	50	56	62	
	•					04	1.3	.58	.76	1.1	1.6	2.2	2.4	3.5	4.1	5.4	42	50	56	61	
	•					05	1.4	.72	.95	1.4	2.0	2.8	3.0	4.4	5.1	6.7	44	50	56	61	
•					055	1.5	.79	1.0	1.5	2.2	3.1	3.3	4.9	5.6	7.4	44	50	56	61		
•					06	1.5	.86	1.1	1.7	2.4	3.4	3.6	5.3	6.1	8.1	45	50	56	60		

**PERFORMANCE DATA
STANDARD ANGLE SPRAY: H-DU AND U**

Spray Angle at 3 bar	Nozzle Type/ Conn. Size (in.)					Capacity Size	Equiv. Orifice Dia. (mm)	Flow Rate Capacity (liters per minute)									Spray Angle (°)			
	H-DU		U					0.4 bar	0.7 bar	1.5 bar	3 bar	6 bar	7 bar	15 bar	20 bar	35 bar	1.5 bar	3 bar	6 bar	15 bar
	1/8	1/4	1	1-1/4	2															
50°	•					07	1.7	1.0	1.3	2.0	2.8	3.9	4.2	6.2	7.1	9.4	45	50	56	60
	•					08	1.8	1.2	1.5	2.2	3.2	4.5	4.8	7.1	8.2	10.8	45	50	55	60
	•	•				10	2.0	1.4	1.9	2.8	3.9	5.6	6.0	8.8	10.2	13.5	45	50	55	59
	•	•				15	2.4	2.2	2.9	4.2	5.9	8.4	9.0	13.2	15.3	20	45	50	55	59
		•				20	2.8	2.9	3.8	5.6	7.9	11.2	12.1	17.7	20	27	45	50	55	59
		•				30	3.4	4.3	5.7	8.4	11.8	16.8	18.1	26	31	40	45	50	55	59
	•	•				40	3.9	5.8	7.6	11.2	15.8	22	24	35	41	54	46	50	54	59
		•				50	4.4	7.2	9.5	14.0	19.7	28	30	44	51	67	46	50	54	59
		•				60	4.8	8.6	11.4	16.8	24	34	36	53	61	81	46	50	54	59
		•				70	5.1	10.1	13.3	19.5	28	39	42	62	71	94	46	50	54	59
				•	•	500	13.4	72	95	140	197	279	302	441	510	674	49	50	51	54
				•		580	14.5	84	111	162	229	324	350	512	591	782	49	50	51	53
					•	750	16.4	108	143	209	296	419	452	662	765	1011	49	50	51	53
					•	1000	19.0	144	191	279	395	558	603	883	1019	1349	49	50	51	53
				•	1500	23.2	216	286	419	592	838	905	1324	1529	2023	49	50	51	52	
				•	2000	26.8	288	381	558	790	1117	1206	1766	2039	2697	49	50	51	52	
40°	•	•				10	2.0	1.4	1.9	2.8	3.9	5.6	6.0	8.8	10.2	13.5	32	40	45	48
	•	•				15	2.4	2.2	2.9	4.2	5.9	8.4	9.0	13.2	15.3	20	32	40	45	48
	•	•				20	2.8	2.9	3.8	5.6	7.9	11.2	12.1	17.7	20	27	32	40	45	48
	•	•				30	3.4	4.3	5.7	8.4	11.8	16.8	18.1	26	31	40	33	40	45	48
	•	•				40	3.9	5.8	7.6	11.2	15.8	22	24	35	41	54	34	40	45	48
		•				50	4.4	7.2	9.5	14.0	19.7	28	30	44	51	67	35	40	45	48
		•				60	4.8	8.6	11.4	16.8	24	34	36	53	61	81	35	40	45	48
		•				70	5.2	10.1	13.3	19.5	28	39	42	62	71	94	35	40	45	48
25°					•	500	13.4	72	95	140	197	279	302	441	510	674	38	40	41	45
	•	•				10	2.0	1.4	1.9	2.8	3.9	5.6	6.0	8.8	10.2	13.5	18	25	31	37
	•	•				15	2.4	2.2	2.9	4.2	5.9	8.4	9.0	13.2	15.3	20	18	25	31	37
	•	•				20	2.8	2.9	3.8	5.6	7.9	11.2	12.1	17.7	20	27	19	25	31	37
	•	•				30	3.4	4.3	5.7	8.4	11.8	16.8	18.1	26	31	40	20	25	30	36
	•	•				40	3.9	5.8	7.6	11.2	15.8	22	24	35	41	54	21	25	29	35
		•				50	4.4	7.2	9.5	14.0	19.7	28	30	44	51	67	21	25	29	35
		•				60	4.8	8.6	11.4	16.8	24	34	36	53	61	81	22	25	29	35
		•				70	5.2	10.1	13.3	19.5	28	39	42	62	71	94	22	25	29	35
				•	•	500	13.4	72	95	140	197	279	302	441	510	674	24	25	26	29
					•	750	16.4	108	143	209	296	419	452	662	765	1011	24	25	26	28
				•	1000	19.0	144	191	279	395	558	603	883	1019	1349	24	25	26	28	

Highlighted column shows the rated pressure.



PERFORMANCE DATA
STANDARD ANGLE SPRAY: H-DU AND U

Spray Angle at 3 bar	Nozzle Type/ Conn. Size (in.)					Capacity Size	Equiv. Orifice Dia. (mm)	Flow Rate Capacity (liters per minute)									Spray Angle (°)			
	H-DU		U					0.4 bar	0.7 bar	1.5 bar	3 bar	6 bar	7 bar	15 bar	20 bar	35 bar	1.5 bar	3 bar	6 bar	15 bar
	1/8	1/4	1	1-1/4	2															
15°	•	•				10	2.0	1.4	1.9	2.8	3.9	5.6	6.0	8.8	10.2	13.5	10	15	19	24
	•	•				15	2.4	2.2	2.9	4.2	5.9	8.4	9.0	13.2	15.3	20	10	15	19	24
	•	•				20	2.8	2.9	3.8	5.6	7.9	11.2	12.1	17.7	20	27	10	15	19	23
	•	•				30	3.4	4.3	5.7	8.4	11.8	16.8	18.1	26	31	40	10	15	19	21
	•	•				40	3.9	5.8	7.6	11.2	15.8	22	24	35	41	54	10	15	18	21
		•				50	4.4	7.2	9.5	14.0	19.7	28	30	44	51	67	11	15	18	21
		•				60	4.8	8.6	11.4	16.8	24	34	36	53	61	81	11	15	18	21
		•				70	5.2	10.1	13.3	19.5	28	39	42	62	71	94	11	15	18	21
				•		500	13.4	72	95	140	197	279	302	441	510	674	14	15	16	17
				•		1000	19.0	144	191	279	395	558	603	883	1019	1349	14	15	16	17
0°		•				03	1.0	.43	.57	.84	1.2	1.7	1.8	2.6	3.1	4.0	0 (solid stream)			
	•	•				04	1.2	.58	.76	1.1	1.6	2.2	2.4	3.5	4.1	5.4				
	•	•				05	1.3	.72	.95	1.4	2.0	2.8	3.0	4.4	5.1	6.7				
	•	•				055	1.4	.79	1.0	1.5	2.2	3.1	3.3	4.9	5.6	7.4				
	•	•				06	1.5	.86	1.1	1.7	2.4	3.4	3.6	5.3	6.1	8.1				
	•	•				065	1.5	.94	1.2	1.8	2.6	3.6	3.9	5.7	6.6	8.8				
	•	•				07	1.6	1.0	1.3	2.0	2.8	3.9	4.2	6.2	7.1	9.4				
	•	•				08	1.7	1.2	1.5	2.2	3.2	4.5	4.8	7.1	8.2	10.8				
	•	•				09	1.8	1.2	1.6	2.4	3.4	4.7	5.1	7.5	8.7	11.5				
	•	•				10	1.8	1.3	1.7	2.5	3.6	5.0	5.4	7.9	9.2	12.1				
		•				12	1.9	1.4	1.9	2.8	3.9	5.6	6.0	8.8	10.2	13.5				
	•	•				15	2.1	1.7	2.3	3.4	4.7	6.7	7.2	10.6	12.2	16.2				
	•	•				20	2.3	2.2	2.9	4.2	5.9	8.4	9.0	13.2	15.3	20				
	•	•				30	2.7	2.9	3.8	5.6	7.9	11.2	12.1	17.7	20	27				
	•	•				40	3.3	4.3	5.7	8.4	11.8	16.8	18.1	26	31	40				
		•				50	3.8	5.8	7.6	11.2	15.8	22	24	35	41	54				
		•				60	4.2	7.2	9.5	14.0	19.7	28	30	44	51	67				
		•				70	4.6	8.6	11.4	16.8	24	34	36	53	61	81				
				•	•	570	14.2	82	109	159	225	318	344	503	581	769				
				•		1000	18.8	144	191	279	395	558	603	883	1019	1349				
			•		1100	19.7	159	210	307	434	614	663	971	1121	1483					
				•	1400	22.2	202	267	391	553	782	844	1236	1427	1888					
				•	1800	25.2	259	343	503	711	1005	1086	1589	1835	2427					
				•	2000	26.5	288	381	558	790	1117	1206	1766	2039	2697					
				•	3500	35.1	505	667	977	1382	1954	2111	3090	3568	4720					

Highlighted column shows the rated pressure.

DIMENSIONS AND WEIGHTS

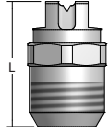
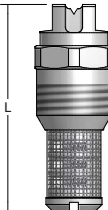
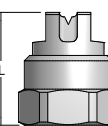
Nozzle	Nozzle Type	Conn. Size/Type (in.)	L (mm)	Hex. (in.)	D (Dia.) (mm)	Net Weight (kg)
	H-VV	1/8 male	19.1	1/2	–	0.01
		1/4 male	19.8	5/8	–	0.02
	H-VVL	1/8 male	28.6	1/2	–	0.02
		1/4 male	28.6	5/8	–	0.04
	H-DT	1/8 female	25.4	9/16	–	0.01
		1/4 female	25.4	9/16	–	0.02

Based on the largest/heaviest version of each type.

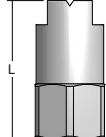
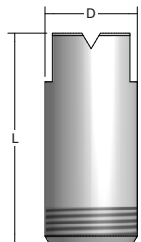
Nozzle	Nozzle Type	Conn. Size/Type (in.)	L (mm)	Hex. (in.)	D (Dia.) (mm)	Net Weight (kg)
	H-DU	1/8 female	38.9	1/2	–	0.02
		1/4 female	31.8	9/16	–	0.03
	U	1 male	58.8	–	33.3	0.26
		1-1/4 male	95.3	–	42.9	0.57
		2 male	136.5	–	60.3	1.93

Based on the largest/heaviest version of each type.

METRIC UNITS

PLACING YOUR ORDER

Call your local spray expert for application assistance or to place an order.

PERFORMANCE DATA
STANDARD ANGLE SPRAY TIPS: QUA, QVVA AND 58106

Spray Angle at 3 bar	Quick VeeJet Tip Type			Capacity Size	Equiv. Orifice Dia. (mm)	Flow Rate Capacity (liters per minute)										Spray Angle (°)			
	QUA	QVVA	58106			0.4 bar	0.7 bar	1.5 bar	3 bar	6 bar	7 bar	12 bar	15 bar	20 bar	1.5 bar	3 bar	6 bar	15 bar	
110°		●	●	01	.66	.14	.19	.28	.39	.56	.60	.79	.88	1.0	94	110	121	124	
		●	●	015	.81	.22	.29	.42	.59	.84	.90	1.2	1.3	1.5	97	110	121	124	
		●	●	02	.91	.29	.38	.56	.79	1.1	1.2	1.6	1.8	2.0	98	110	120	123	
		●	●	03	1.1	.43	.57	.84	1.2	1.7	1.8	2.4	2.6	3.1	99	110	120	123	
		●	●	04	1.3	.58	.76	1.1	1.6	2.2	2.4	3.2	3.5	4.1	100	110	119	122	
		●	●	05	1.4	.72	.95	1.4	2.0	2.8	3.0	3.9	4.4	5.1	100	110	118	122	
		●	●	06	1.5	.86	1.1	1.7	2.4	3.4	3.6	4.7	5.3	6.1	101	110	117	122	
		●	●	08	1.8	1.2	1.5	2.2	3.2	4.5	4.8	6.3	7.1	8.2	102	110	117	121	
		●	●	10	2.0	1.4	1.9	2.8	3.9	5.6	6.0	7.9	8.8	10.2	103	110	117	119	
		●	●	15	2.4	2.2	2.9	4.2	5.9	8.4	9.0	11.8	13.2	15.3	104	110	117	118	
	●	●	20	2.8	2.9	3.8	5.6	7.9	11.2	12.1	15.8	17.7	20	105	110	117	118		
95°		●	●	01	.66	.14	.19	.28	.39	.56	.60	.79	.88	1.0	81	95	105	113	
		●	●	015	.81	.22	.29	.42	.59	.84	.90	1.2	1.3	1.5	82	95	105	113	
		●	●	02	.91	.29	.38	.56	.79	1.1	1.2	1.6	1.8	2.0	82	95	105	113	
		●	●	03	1.1	.43	.57	.84	1.2	1.7	1.8	2.4	2.6	3.1	83	95	104	111	
		●	●	04	1.3	.58	.76	1.1	1.6	2.2	2.4	3.2	3.5	4.1	84	95	103	108	
		●	●	05	1.4	.72	.95	1.4	2.0	2.8	3.0	3.9	4.4	5.1	84	95	102	107	
		●	●	06	1.5	.86	1.1	1.7	2.4	3.4	3.6	4.7	5.3	6.1	86	95	101	106	
		●	●	08	1.8	1.2	1.5	2.2	3.2	4.5	4.8	6.3	7.1	8.2	87	95	100	105	
		●		10	2.0	1.4	1.9	2.8	3.9	5.6	6.0	7.9	8.8	10.2	89	95	100	105	
		●		15	2.4	2.2	2.9	4.2	5.9	8.4	9.0	11.8	13.2	15.3	90	95	100	105	
		●		20	2.8	2.9	3.8	5.6	7.9	11.2	12.1	15.8	17.7	20	90	95	100	105	
		●		30	3.4	4.3	5.7	8.4	11.8	16.8	18.1	24	26	31	91	95	101	105	
		●		40	3.8	5.8	7.6	11.2	15.8	22	24	32	35	41	92	95	100	105	
		●		50	4.4	7.2	9.5	14.0	19.7	28	30	39	44	51	93	95	99	103	
	●		60	4.8	8.6	11.4	16.8	24	34	36	47	53	61	93	95	99	103		
	●		70	5.2	10.1	13.3	19.5	28	39	42	55	62	71	93	95	99	103		
	●	●	150	6.2	14.4	19.1	28	39	56	60	79	88	102	93	95	99	102		
80°		●	●	0050	.46	–	–	.14	.20	.28	.30	.39	.44	.51	61	80	95	101	
		●	●	0067	.53	–	.13	.19	.26	.37	.40	.53	.59	.68	67	80	94	99	
		●	●	01	.66	–	.19	.28	.39	.56	.60	.79	.88	1.0	68	80	89	92	
		●	●	015	.81	.22	.29	.42	.59	.84	.90	1.2	1.3	1.5	68	80	89	92	
		●	●	02	.91	.29	.38	.56	.79	1.1	1.2	1.6	1.8	2.0	69	80	88	91	
	●	●	03	1.1	.43	.57	.84	1.2	1.7	1.8	2.4	2.6	3.1	70	80	87	90		

Highlighted column shows the rated pressure.

FLAT SPRAY
QUICK-CHANGE NOZZLES: QUICKJET® AND UNIJET®

PERFORMANCE
DATA

METRIC UNITS

PERFORMANCE DATA
STANDARD ANGLE SPRAY TIPS: QUA, QVVA AND 58106

Spray Angle at 3 bar	Quick VeeJet Tip Type			Capacity Size	Equiv. Orifice Dia. (mm)	Flow Rate Capacity (liters per minute)										Spray Angle (°)			
	QUA	QVVA	58106			0.4 bar	0.7 bar	1.5 bar	3 bar	6 bar	7 bar	12 bar	15 bar	20 bar	1.5 bar	3 bar	6 bar	15 bar	
80°		●	●	04	1.3	.58	.76	1.1	1.6	2.2	2.4	3.2	3.5	4.1	71	80	86	89	
		●	●	05	1.4	.72	.95	1.4	2.0	2.8	3.0	3.9	4.4	5.1	71	80	86	89	
		●	●	06	1.5	.86	1.1	1.7	2.4	3.4	3.6	4.7	5.3	6.1	72	80	85	88	
		●	●	08	1.8	1.2	1.5	2.2	3.2	4.5	4.8	6.3	7.1	8.2	72	80	84	87	
	●			10	2.0	1.4	1.9	2.8	3.9	5.6	6.0	7.9	8.8	10.2	73	80	84	87	
	●			15	2.4	2.2	2.9	4.2	5.9	8.4	9.0	11.8	13.2	15.3	74	80	83	86	
	●			20	2.8	2.9	3.8	5.6	7.9	11.2	12.1	15.8	17.7	20	74	80	83	86	
	●			30	3.4	4.3	5.7	8.4	11.8	16.8	18.1	24	26	31	74	80	83	86	
	●			40	3.9	5.8	7.6	11.2	15.8	22	24	32	35	41	74	80	83	86	
	●			50	4.4	7.2	9.5	14.0	19.7	28	30	39	44	51	74	80	83	85	
	●			60	4.8	8.6	11.4	16.8	24	34	36	47	53	61	75	80	83	85	
	●			70	5.2	10.1	13.3	19.5	28	39	42	55	62	71	75	80	83	86	
73°		●	●	0023	.30	–	–	.064	.091	.13	.14	.18	.20	.23	50	73	89	97	
		●	●	0039	.41	–	.074	.11	.15	.22	.24	.31	.34	.40	53	73	87	93	
		●	●	0077	.58	–	.15	.21	.30	.43	.46	.61	.68	.78	53	73	86	92	
		●	●	0116	.71	.17	.22	.32	.46	.65	.70	.92	1.0	1.2	54	73	85	90	
		●	●	0154	.81	.22	.29	.43	.61	.86	.93	1.2	1.4	1.6	55	73	84	88	
		●	●	0231	.96	.33	.44	.64	.91	1.3	1.4	1.8	2.0	2.4	56	73	83	87	
		●	●	0308	1.1	.44	.59	.86	1.2	1.7	1.9	2.4	2.7	3.1	58	73	82	86	
		●	●	0385	1.2	.56	.73	1.1	1.5	2.1	2.3	3.0	3.4	3.9	59	73	81	85	
		●	●	0462	1.4	.67	.88	1.3	1.8	2.6	2.8	3.6	4.1	4.7	60	73	80	84	
		●	●	0616	1.6	.89	1.2	1.7	2.4	3.4	3.7	4.9	5.4	6.3	63	73	79	83	
		●	●	0770	1.7	1.1	1.5	2.1	3.0	4.3	4.6	6.1	6.8	7.8	64	73	77	82	
		●	●	0924	1.9	1.3	1.8	2.6	3.6	5.2	5.6	7.3	8.2	9.4	65	73	77	80	
65°		●	●	0017	.28	–	–	.047	.067	.095	.10	.13	.15	.17	44	65	77	86	
		●	●	0025	.33	–	–	.070	.099	.14	.15	.20	.22	.25	45	65	77	84	
		●	●	0033	.38	–	–	.092	.13	.18	.20	.26	.29	.34	47	65	76	83	
		●	●	0050	.46	–	–	.14	.20	.28	.30	.39	.44	.51	48	65	75	82	
		●	●	0067	.53	–	.13	.19	.26	.37	.40	.53	.59	.68	50	65	75	81	
		●	●	01	.66	–	.19	.28	.39	.56	.60	.79	.88	1.0	51	65	74	80	
		●	●	015	.81	–	.29	.42	.59	.84	.90	1.2	1.3	1.5	51	65	74	80	
		●	●	02	.91	.29	.38	.56	.79	1.1	1.2	1.6	1.8	2.0	52	65	73	79	
		●	●	03	1.1	.43	.57	.84	1.2	1.7	1.8	2.4	2.6	3.1	53	65	72	78	
		●	●	04	1.3	.58	.76	1.1	1.6	2.2	2.4	3.2	3.5	4.1	53	65	72	76	
		●	●	05	1.4	.72	.95	1.4	2.0	2.8	3.0	3.9	4.4	5.1	53	65	72	76	

Highlighted column shows the rated pressure.



PERFORMANCE DATA

FLAT SPRAY
QUICK-CHANGE NOZZLES: QUICKJET® AND UNIJET®

METRIC UNITS

PERFORMANCE DATA
STANDARD ANGLE SPRAY TIPS: QUA, QVVA AND 58106

Spray Angle at 3 bar	Quick VeeJet Tip Type			Capacity Size	Equiv. Orifice Dia. (mm)	Flow Rate Capacity (liters per minute)										Spray Angle (°)			
	QUA	QVVA	58106			0.4 bar	0.7 bar	1.5 bar	3 bar	6 bar	7 bar	12 bar	15 bar	20 bar	1.5 bar	3 bar	6 bar	15 bar	
65°		●	●	06	1.5	.86	1.1	1.7	2.4	3.4	3.6	4.7	5.3	6.1	54	65	72	75	
		●	●	08	1.8	1.2	1.5	2.2	3.2	4.5	4.8	6.3	7.1	8.2	55	65	71	74	
	●			10	2.0	1.4	1.9	2.8	3.9	5.6	6.0	7.9	8.8	10.2	56	65	71	74	
	●			15	2.4	2.2	2.9	4.2	5.9	8.4	9.0	11.8	13.2	15.3	56	65	70	73	
	●			20	2.8	2.9	3.8	5.6	7.9	11.2	12.1	15.8	17.7	20	57	65	70	73	
	●			30	3.4	4.3	5.7	8.4	11.8	16.8	18.1	24	26	31	58	65	69	72	
	●			40	3.9	5.8	7.6	11.2	15.8	22	24	32	35	41	59	65	68	72	
	●			50	4.4	7.2	9.5	14.0	19.7	28	30	39	44	51	60	65	68	71	
	●			60	4.8	8.6	11.4	16.8	24	34	36	47	53	61	60	65	68	71	
	●			70	5.2	10.1	13.3	19.5	28	39	42	55	62	71	60	65	68	71	
50°		●	●	0017	.28	–	–	.047	.067	.095	.10	.13	.15	.17	27	50	65	74	
		●	●	0025	.33	–	–	.070	.099	.14	.15	.20	.22	.25	29	50	64	71	
		●	●	0033	.38	–	–	.092	.13	.18	.20	.26	.29	.34	30	50	62	68	
		●	●	0050	.46	–	–	.14	.20	.28	.30	.39	.44	.51	32	50	60	66	
		●	●	0067	.53	–	–	.19	.26	.37	.40	.53	.59	.68	35	50	60	66	
		●	●	01	.66	–	.19	.28	.39	.56	.60	.79	.88	1.0	37	50	59	65	
		●	●	015	.81	–	.29	.42	.59	.84	.90	1.2	1.3	1.5	38	50	58	64	
		●	●	02	.91	–	.38	.56	.79	1.1	1.2	1.6	1.8	2.0	39	50	57	63	
		●	●	03	1.1	.43	.57	.84	1.2	1.7	1.8	2.4	2.6	3.1	40	50	56	62	
		●	●	04	1.3	.58	.76	1.1	1.6	2.2	2.4	3.2	3.5	4.1	42	50	56	61	
		●	●	05	1.4	.72	.95	1.4	2.0	2.8	3.0	3.9	4.4	5.1	44	50	56	61	
		●	●	06	1.5	.86	1.1	1.7	2.4	3.4	3.6	4.7	5.3	6.1	45	50	56	60	
		●	●	08	1.8	1.2	1.5	2.2	3.2	4.5	4.8	6.3	7.1	8.2	45	50	55	60	
	●			10	2.0	1.4	1.9	2.8	3.9	5.6	6.0	7.9	8.8	10.2	45	50	55	59	
	●			15	2.4	2.2	2.9	4.2	5.9	8.4	9.0	11.8	13.2	15.3	45	50	55	59	
	●			20	2.8	2.9	3.8	5.6	7.9	11.2	12.1	15.8	17.7	20	45	50	55	59	
	●			30	3.4	4.3	5.7	8.4	11.8	16.8	18.1	24	26	31	45	50	55	59	
	●			40	3.9	5.8	7.6	11.2	15.8	22	24	32	35	41	46	50	54	59	
	●			50	4.4	7.2	9.5	14.0	19.7	28	30	39	44	51	46	50	54	59	
	●			60	4.8	8.6	11.4	16.8	24	34	36	47	53	61	46	50	54	59	
●			70	5.2	10.1	13.3	19.5	28	39	42	55	62	71	46	50	54	59		
40°		●	●	0017	.28	–	–	.047	.067	.095	.10	.13	.15	.17	21	40	54	61	
		●	●	0025	.33	–	–	.070	.099	.14	.15	.20	.22	.25	22	40	53	60	
		●	●	0033	.38	–	–	.092	.13	.18	.20	.26	.29	.34	22	40	53	60	
		●	●	0050	.46	–	–	.14	.20	.28	.30	.39	.44	.51	22	40	53	60	

Highlighted column shows the rated pressure.

FLAT SPRAY
QUICK-CHANGE NOZZLES: QUICKJET® AND UNIJET®

PERFORMANCE
DATA

METRIC UNITS

PERFORMANCE DATA
STANDARD ANGLE SPRAY TIPS: QUA, QVVA AND 58106

Spray Angle at 3 bar	Quick VeeJet Tip Type			Capacity Size	Equiv. Orifice Dia. (mm)	Flow Rate Capacity (liters per minute)										Spray Angle (°)			
	QUA	QVVA	58106			0.4 bar	0.7 bar	1.5 bar	3 bar	6 bar	7 bar	12 bar	15 bar	20 bar	1.5 bar	3 bar	6 bar	15 bar	
40°		●	●	0067	.53	–	–	.19	.26	.37	.40	.53	.59	.68	24	40	53	60	
		●	●	01	.66	–	–	.28	.39	.56	.60	.79	.88	1.0	26	40	52	59	
		●	●	015	.81	–	–	.42	.59	.84	.90	1.2	1.3	1.5	27	40	52	59	
		●	●	02	.91	–	.38	.56	.79	1.1	1.2	1.6	1.8	2.0	29	40	51	58	
		●	●	03	1.1	–	.57	.84	1.2	1.7	1.8	2.4	2.6	3.1	30	40	50	57	
		●	●	04	1.3	–	.76	1.1	1.6	2.2	2.4	3.2	3.5	4.1	30	40	50	56	
		●	●	05	1.4	–	.95	1.4	2.0	2.8	3.0	3.9	4.4	5.1	31	40	49	55	
		●	●	06	1.5	–	1.1	1.7	2.4	3.4	3.6	4.7	5.3	6.1	31	40	49	55	
		●	●	08	1.8	1.2	1.5	2.2	3.2	4.5	4.8	6.3	7.1	8.2	31	40	47	53	
		●		10	2.0	1.4	1.9	2.8	3.9	5.6	6.0	7.9	8.8	10.2	32	40	45	48	
		●		15	2.4	2.2	2.9	4.2	5.9	8.4	9.0	11.8	13.2	15.3	32	40	45	48	
		●		20	2.8	2.9	3.8	5.6	7.9	11.2	12.1	15.8	17.7	20	32	40	45	48	
		●		30	3.4	4.3	5.7	8.4	11.8	16.8	18.1	24	26	31	33	40	45	48	
		●		40	3.9	5.8	7.6	11.2	15.8	22	24	32	35	41	34	40	45	48	
		●		50	4.4	7.2	9.5	14.0	19.7	28	30	39	44	51	35	40	45	48	
		●		60	4.8	8.6	11.4	16.8	24	34	36	47	53	61	35	40	45	48	
		●		70	5.2	10.1	13.3	19.5	28	39	42	55	62	71	35	40	45	48	
25°		●	●	0017	.28	–	–	–	.067	.095	.10	.13	.15	.17	–	25	35	47	
		●	●	0025	.33	–	–	–	.099	.14	.15	.20	.22	.25	–	25	35	45	
		●	●	0033	.38	–	–	–	.13	.18	.20	.26	.29	.34	–	25	34	44	
		●	●	0050	.46	–	–	–	.20	.28	.30	.39	.44	.51	–	25	34	43	
		●	●	0067	.53	–	–	–	.26	.37	.40	.53	.59	.68	–	25	34	42	
		●	●	01	.66	–	–	.28	.39	.56	.60	.79	.88	1.0	14	25	34	42	
		●	●	015	.81	–	–	.42	.59	.84	.90	1.2	1.3	1.5	15	25	34	41	
		●	●	02	.91	–	–	.56	.79	1.1	1.2	1.6	1.8	2.0	15	25	33	40	
		●	●	03	1.1	–	–	.84	1.2	1.7	1.8	2.4	2.6	3.1	15	25	33	40	
		●	●	04	1.3	–	.76	1.1	1.6	2.2	2.4	3.2	3.5	4.1	16	25	32	39	
		●	●	05	1.4	–	.95	1.4	2.0	2.8	3.0	3.9	4.4	5.1	16	25	32	39	
		●	●	06	1.5	–	1.1	1.7	2.4	3.4	3.6	4.7	5.3	6.1	17	25	31	38	
		●	●	08	1.8	–	1.5	2.2	3.2	4.5	4.8	6.3	7.1	8.2	17	25	31	38	
		●		10	2.0	–	1.9	2.8	3.9	5.6	6.0	7.9	8.8	10.2	18	25	31	37	
		●		15	2.4	–	2.9	4.2	5.9	8.4	9.0	11.8	13.2	15.3	18	25	31	37	
		●		20	2.8	–	3.8	5.6	7.9	11.2	12.1	15.8	17.7	20	19	25	31	37	
		●		30	3.4	4.3	5.7	8.4	11.8	16.8	18.1	24	26	31	20	25	30	36	
	●		40	3.9	5.8	7.6	11.2	15.8	22	24	32	35	41	21	25	29	35		

Highlighted column shows the rated pressure.



PERFORMANCE DATA

FLAT SPRAY
QUICK-CHANGE NOZZLES: QUICKJET® AND UNIJET®

METRIC UNITS

PERFORMANCE DATA
STANDARD ANGLE SPRAY TIPS: QUA, QVVA AND 58106

Spray Angle at 3 bar	Quick VeeJet Tip Type			Capacity Size	Equiv. Orifice Dia. (mm)	Flow Rate Capacity (liters per minute)										Spray Angle (°)			
	QUA	QVVA	58106			0.4 bar	0.7 bar	1.5 bar	3 bar	6 bar	7 bar	12 bar	15 bar	20 bar	1.5 bar	3 bar	6 bar	15 bar	
25°	●			50	4.4	7.2	9.5	14.0	19.7	28	30	39	44	51	21	25	29	35	
	●			60	4.8	8.6	11.4	16.8	24	34	36	47	53	61	22	25	29	35	
	●			70	5.2	10.1	13.3	19.5	28	39	42	55	62	71	22	25	29	35	
15°		●	●	0017	.28	-	-	-	.067	.095	.10	.13	.15	.17	-	15	30	37	
		●	●	0025	.33	-	-	-	.099	.14	.15	.20	.22	.25	-	15	28	34	
		●	●	0033	.38	-	-	-	.13	.18	.20	.26	.29	.34	-	15	27	32	
		●	●	0050	.46	-	-	-	.20	.28	.30	.39	.44	.51	-	15	26	30	
		●	●	0067	.53	-	-	-	.26	.37	.40	.53	.59	.68	-	15	25	29	
		●	●	01	.66	-	-	-	.39	.56	.60	.79	.88	1.0	-	15	24	28	
		●	●	015	.81	-	-	-	.59	.84	.90	1.2	1.3	1.5	-	15	23	27	
		●	●	02	.91	-	-	.56	.79	1.1	1.2	1.6	1.8	2.0	6	15	22	27	
		●	●	03	1.1	-	-	.84	1.2	1.7	1.8	2.4	2.6	3.1	6	15	22	27	
		●	●	04	1.3	-	-	1.1	1.6	2.2	2.4	3.2	3.5	4.1	7	15	21	26	
		●	●	05	1.4	-	-	1.4	2.0	2.8	3.0	3.9	4.4	5.1	7	15	21	26	
		●	●	06	1.5	-	-	1.7	2.4	3.4	3.6	4.7	5.3	6.1	8	15	21	26	
		●	●	08	1.8	-	-	2.2	3.2	4.5	4.8	6.3	7.1	8.2	9	15	20	25	
		●			10	2.0	1.4	1.9	2.8	3.9	5.6	6.0	7.9	8.8	10.2	10	15	19	24
		●			15	2.4	2.2	2.9	4.2	5.9	8.4	9.0	11.8	13.2	15.3	10	15	19	24
		●			20	2.8	2.9	3.8	5.6	7.9	11.2	12.1	15.8	17.7	20	10	15	19	23
		●			30	3.4	4.3	5.7	8.4	11.8	16.8	18.1	24	26	31	10	15	19	21
		●			40	3.9	5.8	7.6	11.2	15.8	22	24	32	35	41	10	15	18	21
		●			50	4.4	7.2	9.5	14.0	19.7	28	30	39	44	51	11	15	18	21
		●			60	4.8	8.6	11.4	16.8	24	34	36	47	53	61	11	15	18	21
	●			70	5.2	10.1	13.3	19.5	28	39	42	55	62	71	11	15	18	21	
0°		●	●	0009	.20	.013	.017	.025	.036	.050	.054	.071	.079	.092	0 (solid stream)				
		●	●	0012	.25	.017	.023	.034	.047	.067	.072	.095	.11	.12					
		●	●	0019	.30	.027	.036	.053	.075	.11	.11	.15	.17	.19					
		●	●	0021	.33	.030	.040	.059	.083	.12	.13	.17	.19	.21					
		●	●	0050	.48	.072	.095	.14	.20	.28	.30	.39	.44	.51					
		●	●	0067	.58	.097	.13	.19	.26	.37	.40	.53	.59	.68					
		●	●	01	.71	.14	.19	.28	.39	.56	.60	.79	.88	1.0					
		●	●	015	.86	.22	.29	.42	.59	.84	.90	1.2	1.3	1.5					
		●	●	02	.99	.29	.38	.56	.79	1.1	1.2	1.6	1.8	2.0					
		●	●	03	1.2	.43	.57	.84	1.2	1.7	1.8	2.4	2.6	3.1					
		●	●	04	1.4	.58	.76	1.1	1.6	2.2	2.4	3.2	3.5	4.1					

Highlighted column shows the rated pressure.

**PERFORMANCE DATA
 STANDARD ANGLE SPRAY TIPS: QUA, QVVA AND 58106**

Spray Angle at 3 bar	Quick VeeJet Tip Type			Capacity Size	Equiv. Orifice Dia. (mm)	Flow Rate Capacity (liters per minute)										Spray Angle (°)			
	QUA	QVVA	58106			0.4 bar	0.7 bar	1.5 bar	3 bar	6 bar	7 bar	12 bar	15 bar	20 bar	1.5 bar	3 bar	6 bar	15 bar	
0°	●	●	●	05	1.6	.72	.95	1.4	2.0	2.8	3.0	3.9	4.4	5.1	0 (solid stream)				
	●	●	●	06	1.7	.86	1.1	1.7	2.4	3.4	3.6	4.7	5.3	6.1					
	●	●	●	08	2.0	1.2	1.5	2.2	3.2	4.5	4.8	6.3	7.1	8.2					
	●			10	2.2	1.4	1.9	2.8	3.9	5.6	6.0	7.9	8.8	10.2					
	●			15	2.7	2.2	2.9	4.2	5.9	8.4	9.0	11.8	13.2	15.3					
	●			20	3.1	2.9	3.8	5.6	7.9	11.2	12.1	15.8	17.7	20					
	●			30	3.6	4.3	5.7	8.4	11.8	16.8	18.1	24	26	31					
	●			40	4.1	5.8	7.6	11.2	15.8	22	24	32	35	41					
	●			50	4.2	7.2	9.5	14.0	19.7	28	30	39	44	51					
	●			60	4.6	8.6	11.4	16.8	24	34	36	47	53	61					
	●			70	5.0	10.1	13.3	19.5	28	39	42	55	62	71					
	●			80	5.3	11.5	15.3	22	32	45	48	63	71	82					

Highlighted column shows the rated pressure.

ASSEMBLY DIMENSIONS AND WEIGHTS

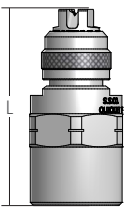
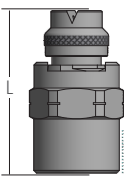
Nozzle	Tip/Body Type	Conn. Size (in.)	L (mm)	Hex. (in.)	Net Weight (kg)
	QVVA + QJA	1/8, 1/4, 3/8, 1/2 female	54.8	1	0.06
	QVVA + QJJA	1/8, 1/4, 3/8, 1/2 male	53.0	1	0.08
	QUA + QJA	1/8, 1/4, 3/8, 1/2 female	50.8	1	0.11
	QUA + QJJA	1/8, 1/4, 3/8, 1/2 male	48.4	1	0.11

Based on the largest/heaviest version of each type.

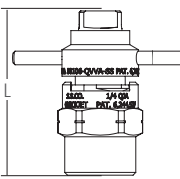
Nozzle	Tip/Body Type	Conn. Size/Type (in.)	L (mm)	Hex. (in.)	Net Weight (kg)
	58106 - QVVA + QJA	1/8, 1/4, 3/8, 1/2 female	54.5	2	0.06

Based on the largest/heaviest version of each type.

SPRAY TIP DIMENSIONS

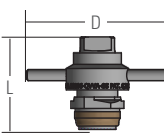
Nozzle	Nozzle Type	L (mm)	D (Dia.) (mm)
	58106*	31.8	50.8

*58106 fits on any QuickJet body.

PERFORMANCE DATA

FLAT SPRAY
QUICK-CHANGE NOZZLES: UNIJET® VEEJET®

METRIC UNITS

PERFORMANCE DATA
STANDARD ANGLE SPRAY TIPS: 13802, TPU, 58102 AND 49803

Spray Angle at 3 bar	UniJet Tip Type				Capacity Size	Equiv. Orifice Dia. (mm)	Flow Rate Capacity (liters per minute)										Spray Angle (°)			
	13802	TPU	58102	49803			0.4 bar	0.7 bar	1.5 bar	3 bar	6 bar	7 bar	15 bar	20 bar	35 bar	1.5 bar	3 bar	6 bar	15 bar	
110°	•	•	•		0033	.38	-	-	.092	.13	.18	.20	.29	.34	.45	91	110	116	121	
	•	•	•		0050	.46	-	-	.14	.20	.28	.30	.44	.51	.67	91	110	118	124	
	•	•	•		0067	.53	-	-	.19	.26	.37	.40	.59	.68	.90	92	110	118	124	
	•	•	•		01	.66	.14	.19	.28	.39	.56	.60	.88	1.0	1.3	94	110	121	124	
	•	•	•		015	.81	.22	.29	.42	.59	.84	.90	1.3	1.5	2.0	97	110	121	124	
	•	•	•		02	.89	.29	.38	.56	.79	1.1	1.2	1.8	2.0	2.7	98	110	120	123	
	•	•	•		03	1.1	.43	.57	.84	1.2	1.7	1.8	2.6	3.1	4.0	99	110	120	123	
	•	•	•		04	1.3	.58	.76	1.1	1.6	2.2	2.4	3.5	4.1	5.4	100	110	119	122	
	•	•	•		05	1.4	.72	.95	1.4	2.0	2.8	3.0	4.4	5.1	6.7	100	110	118	122	
	•	•	•		06	1.6	.86	1.1	1.7	2.4	3.4	3.6	5.3	6.1	8.1	101	110	117	122	
	•	•	•		07	1.7	1.0	1.3	2.0	2.8	3.9	4.2	6.2	7.1	9.4	102	110	117	121	
	•	•	•		08	1.8	1.2	1.5	2.2	3.2	4.5	4.8	7.1	8.2	10.8	102	110	117	121	
	•	•		•	10	2.0	1.4	1.9	2.8	3.9	5.6	6.0	8.8	10.2	13.5	103	110	117	119	
	•	•		•	12	2.2	1.7	2.3	3.4	4.7	6.7	7.2	10.6	12.2	16.2	103	110	117	119	
	•	•		•	15	2.5	2.2	2.9	4.2	5.9	8.4	9.0	13.2	15.3	20	104	110	117	118	
	•	•		•	20	2.8	2.9	3.8	5.6	7.9	11.2	12.1	17.7	20	27	105	110	117	118	
	•	•		•	30	2.9	4.3	5.7	8.4	11.8	16.8	18.1	26	31	40	105	110	117	118	
95°	•	•	•		01	.66	.14	.19	.28	.39	.56	.60	.88	1.0	1.3	81	95	105	113	
	•	•	•		015	.81	.22	.29	.42	.59	.84	.90	1.3	1.5	2.0	82	95	105	113	
	•	•	•		02	.89	.29	.38	.56	.79	1.1	1.2	1.8	2.0	2.7	82	95	105	113	
	•	•	•		03	1.1	.43	.57	.84	1.2	1.7	1.8	2.6	3.1	4.0	83	95	104	111	
	•	•	•		04	1.3	.58	.76	1.1	1.6	2.2	2.4	3.5	4.1	5.4	84	95	103	108	
	•	•	•		05	1.4	.72	.95	1.4	2.0	2.8	3.0	4.4	5.1	6.7	84	95	102	107	
	•	•	•		06	1.5	.86	1.1	1.7	2.4	3.4	3.6	5.3	6.1	8.1	86	95	101	106	
	•	•	•		07	1.7	1.0	1.3	2.0	2.8	3.9	4.2	6.2	7.1	9.4	86	95	101	106	
	•	•	•		08	1.8	1.2	1.5	2.2	3.2	4.5	4.8	7.1	8.2	10.8	87	95	100	105	
	•	•	•		09	1.9	1.3	1.7	2.5	3.6	5.0	5.4	7.9	9.2	12.1	89	95	100	105	
	•	•		•	10	2.0	1.4	1.9	2.8	3.9	5.6	6.0	8.8	10.2	13.5	89	95	100	105	
	•	•		•	11	2.1	1.6	2.1	3.1	4.3	6.1	6.6	9.7	11.2	14.8	89	95	100	105	
	•	•		•	12	2.2	1.7	2.3	3.4	4.7	6.7	7.2	10.6	12.2	16.2	89	95	100	105	
	•	•	•		13	2.3	1.9	2.5	3.6	5.1	7.3	7.8	11.5	13.3	17.5	89	95	100	105	
	•	•	•		14	2.4	2.0	2.7	3.9	5.5	7.8	8.4	12.4	14.3	18.9	89	95	100	105	
	•	•		•	15	2.5	2.2	2.9	4.2	5.9	8.4	9.0	13.2	15.3	20	90	95	100	105	
	•	•		•	16	2.5	2.3	3.1	4.5	6.3	8.9	9.6	14.1	16.3	22	90	95	100	105	
	•	•		•	18	2.7	2.6	3.4	5.0	7.1	10.1	10.9	15.9	18.3	24	90	95	100	105	
	•	•		•	20	2.8	2.9	3.8	5.6	7.9	11.2	12.1	17.7	20	27	90	95	100	105	
	•	•		•	30	3.4	4.3	5.7	8.4	11.8	16.8	18.1	26	31	40	91	95	101	105	
•	•		•	40	3.9	5.8	7.6	11.2	15.8	22	24	35	41	54	92	95	100	105		
•	•		•	50	4.4	7.2	9.5	14.0	19.7	28	30	44	51	67	93	95	99	103		
•	•		•	60	4.8	8.6	11.4	16.8	24	34	36	53	61	81	93	95	99	103		
•	•		•	70	5.2	10.1	13.3	19.5	28	39	42	62	71	94	93	95	99	103		

Other body types may be available. Contact your sales engineer for further information.

Highlighted column shows the rated pressure.



**PERFORMANCE DATA
STANDARD ANGLE SPRAY TIPS: 13802, TPU, 58102 AND 49803**

Spray Angle at 3 bar	UniJet Tip Type				Capacity Size	Equiv. Orifice Dia. (mm)	Flow Rate Capacity (liters per minute)										Spray Angle (°)			
	13802	TPU	58102	49803			0.4 bar	0.7 bar	1.5 bar	3 bar	6 bar	7 bar	15 bar	20 bar	35 bar	1.5 bar	3 bar	6 bar	15 bar	
80°	•	•	•		0050	.46	-	-	.14	.20	.28	.30	.44	.51	.67	61	80	95	101	
	•	•	•		0067	.53	-	.13	.19	.26	.37	.40	.59	.68	.90	67	80	94	99	
	•	•	•		01	.66	-	.19	.28	.39	.56	.60	.88	1.0	1.3	68	80	89	92	
	•	•	•		015	.81	-	.29	.42	.59	.84	.90	1.3	1.5	2.0	68	80	89	92	
	•	•	•		02	.89	.29	.38	.56	.79	1.1	1.2	1.8	2.0	2.7	69	80	88	91	
	•	•	•		03	1.1	.43	.57	.84	1.2	1.7	1.8	2.6	3.1	4.0	70	80	87	90	
	•	•	•		04	1.3	.58	.76	1.1	1.6	2.2	2.4	3.5	4.1	5.4	71	80	86	89	
	•	•	•		045	1.4	.65	.86	1.3	1.8	2.5	2.7	4.0	4.6	6.1	71	80	86	89	
	•	•	•		05	1.4	.72	.95	1.4	2.0	2.8	3.0	4.4	5.1	6.7	71	80	86	89	
	•	•	•		06	1.6	.86	1.1	1.7	2.4	3.4	3.6	5.3	6.1	8.1	72	80	85	88	
	•	•	•		07	1.7	1.0	1.3	2.0	2.8	3.9	4.2	6.2	7.1	9.4	72	80	85	88	
	•	•	•		08	1.8	1.2	1.5	2.2	3.2	4.5	4.8	7.1	8.2	10.8	72	80	84	87	
	•	•	•		09	1.9	1.3	1.7	2.5	3.6	5.0	5.4	7.9	9.2	12.1	73	80	84	87	
	•	•		•	10	2.0	1.4	1.9	2.8	3.9	5.6	6.0	8.8	10.2	13.5	73	80	84	87	
	•	•		•	11	2.1	1.6	2.1	3.1	4.3	6.1	6.6	9.7	11.2	14.8	73	80	83	86	
	•	•		•	12	2.2	1.7	2.3	3.4	4.7	6.7	7.2	10.6	12.2	16.2	73	80	83	86	
	•	•		•	13	2.3	1.9	2.5	3.6	5.1	7.3	7.8	11.5	13.3	17.5	73	80	83	86	
	•	•		•	14	2.4	2.0	2.7	3.9	5.5	7.8	8.4	12.4	14.3	18.9	73	80	83	86	
	•	•		•	15	2.5	2.2	2.9	4.2	5.9	8.4	9.0	13.2	15.3	20	74	80	83	86	
	•	•		•	16	2.5	2.3	3.1	4.5	6.3	8.9	9.6	14.1	16.3	22	74	80	83	86	
•	•		•	17	2.6	2.5	3.2	4.7	6.7	9.5	10.3	15.0	17.3	23	74	80	83	86		
•	•		•	20	2.8	2.9	3.8	5.6	7.9	11.2	12.1	17.7	20	27	74	80	83	86		
•	•		•	25	3.1	3.6	4.8	7.0	9.9	14.0	15.1	22	25	34	74	80	83	86		
•	•		•	30	3.4	4.3	5.7	8.4	11.8	16.8	18.1	26	31	40	74	80	83	86		
•	•		•	40	3.9	5.8	7.6	11.2	15.8	22	24	35	41	54	74	80	83	86		
•	•		•	50	4.4	7.2	9.5	14.0	19.7	28	30	44	51	67	74	80	83	85		
•	•		•	60	4.8	8.6	11.4	16.8	24	34	36	53	61	81	75	80	83	85		
•	•		•	70	5.2	10.1	13.3	19.5	28	39	42	62	71	94	75	80	83	86		
73°	•	•	•		0023	.30	-	-	.064	.091	.13	.14	.20	.23	.31	50	73	89	97	
	•	•	•		0039	.41	-	.074	.11	.15	.22	.24	.34	.40	.53	53	73	87	93	
	•	•	•		0077	.58	-	.15	.21	.30	.43	.46	.68	.78	1.0	53	73	86	92	
	•	•	•		0116	.71	.17	.22	.32	.46	.65	.70	1.0	1.2	1.6	54	73	85	90	
	•	•	•		0154	.81	.22	.29	.43	.61	.86	.93	1.4	1.6	2.1	55	73	84	88	
	•	•	•		0231	.96	.33	.44	.64	.91	1.3	1.4	2.0	2.4	3.1	56	73	83	87	
	•	•	•		0308	1.1	.44	.59	.86	1.2	1.7	1.9	2.7	3.1	4.2	58	73	82	86	
	•	•	•		0385	1.2	.56	.73	1.1	1.5	2.1	2.3	3.4	3.9	5.2	59	73	81	85	
	•	•	•		0462	1.4	.67	.88	1.3	1.8	2.6	2.8	4.1	4.7	6.2	60	73	80	84	
	•	•	•		0616	1.6	.89	1.2	1.7	2.4	3.4	3.7	5.4	6.3	8.3	63	73	79	83	
	•	•	•		0770	1.8	1.1	1.5	2.1	3.0	4.3	4.6	6.8	7.8	10.4	64	73	77	82	
	•	•	•		0924	1.9	1.3	1.8	2.6	3.6	5.2	5.6	8.2	9.4	12.5	65	73	77	80	

Other body types may be available. Contact your sales engineer for further information.

Highlighted column shows the rated pressure.

PERFORMANCE DATA

FLAT SPRAY
QUICK-CHANGE NOZZLES: UNIJET® VEEJET®

METRIC UNITS

PERFORMANCE DATA
STANDARD ANGLE SPRAY TIPS: 13802, TPU, 58102 AND 49803

Spray Angle at 3 bar	UniJet Tip Type				Capacity Size	Equiv. Orifice Dia. (mm)	Flow Rate Capacity (liters per minute)										Spray Angle (°)			
	13802	TPU	58102	49803			0.4 bar	0.7 bar	1.5 bar	3 bar	6 bar	7 bar	15 bar	20 bar	35 bar	1.5 bar	3 bar	6 bar	15 bar	
65°	•	•	•		0017	.28	-	-	.047	.067	.095	.10	.15	.17	.23	44	65	77	86	
	•	•	•		0025	.33	-	-	.070	.099	.14	.15	.22	.25	.34	45	65	77	84	
	•	•	•		0033	.38	-	-	.092	.13	.18	.20	.29	.34	.45	47	65	76	83	
	•	•	•		0050	.46	-	-	.14	.20	.28	.30	.44	.51	.67	48	65	75	82	
	•	•	•		0067	.53	-	.13	.19	.26	.37	.40	.59	.68	.90	50	65	75	81	
	•	•	•		01	.66	-	.19	.28	.39	.56	.60	.88	1.0	1.3	51	65	74	80	
	•	•	•		015	.81	-	.29	.42	.59	.84	.90	1.3	1.5	2.0	51	65	74	80	
	•	•	•		02	.89	.29	.38	.56	.79	1.1	1.2	1.8	2.0	2.7	52	65	73	79	
	•	•	•		025	.99	.36	.48	.70	.99	1.4	1.5	2.2	2.5	3.4	52	65	73	79	
	•	•	•		03	1.1	.43	.57	.84	1.2	1.7	1.8	2.6	3.1	4.0	53	65	72	78	
	•	•	•		035	1.2	.50	.67	.98	1.4	2.0	2.1	3.1	3.6	4.7	53	65	72	78	
	•	•	•		04	1.3	.58	.76	1.1	1.6	2.2	2.4	3.5	4.1	5.4	53	65	72	76	
	•	•	•		05	1.4	.72	.95	1.4	2.0	2.8	3.0	4.4	5.1	6.7	53	65	72	76	
	•	•	•		055	1.5	.79	1.0	1.5	2.2	3.1	3.3	4.9	5.6	7.4	53	65	72	76	
	•	•	•		06	1.6	.86	1.1	1.7	2.4	3.4	3.6	5.3	6.1	8.1	54	65	72	75	
	•	•	•		07	1.7	1.0	1.3	2.0	2.8	3.9	4.2	6.2	7.1	9.4	54	65	72	75	
	•	•	•		08	1.8	1.2	1.5	2.2	3.2	4.5	4.8	7.1	8.2	10.8	55	65	71	74	
	•	•	•		09	1.9	1.3	1.7	2.5	3.6	5.0	5.4	7.9	9.2	12.1	55	65	71	74	
	•	•		•	10	2.0	1.4	1.9	2.8	3.9	5.6	6.0	8.8	10.2	13.5	56	65	71	74	
	•	•		•	11	2.1	1.6	2.1	3.1	4.3	6.1	6.6	9.7	11.2	14.8	56	65	71	74	
•	•		•	12	2.2	1.7	2.3	3.4	4.7	6.7	7.2	10.6	12.2	16.2	56	65	71	74		
•	•		•	13	2.3	1.9	2.5	3.6	5.1	7.3	7.8	11.5	13.3	17.5	56	65	71	74		
•	•		•	14	2.4	2.0	2.7	3.9	5.5	7.8	8.4	12.4	14.3	18.9	56	65	71	74		
•	•		•	15	2.5	2.2	2.9	4.2	5.9	8.4	9.0	13.2	15.3	20	56	65	70	73		
•	•		•	20	2.8	2.9	3.8	5.6	7.9	11.2	12.1	17.7	20	27	57	65	70	73		
•	•		•	30	3.4	4.3	5.7	8.4	11.8	16.8	18.1	26	31	40	58	65	69	72		
•	•		•	40	3.8	5.8	7.6	11.2	15.8	22	24	35	41	54	59	65	68	72		
•	•		•	50	4.4	7.2	9.5	14.0	19.7	28	30	44	51	67	60	65	68	71		
•	•		•	60	4.8	8.6	11.4	16.8	24	34	36	53	61	81	60	65	68	71		
•	•		•	70	5.2	10.1	13.3	19.5	28	39	42	62	71	94	60	65	68	71		
50°	•	•	•		0017	.28	-	-	.047	.067	.095	.10	.15	.17	.23	27	50	65	74	
	•	•	•		0025	.33	-	-	.070	.099	.14	.15	.22	.25	.34	29	50	64	71	
	•	•	•		0033	.38	-	-	.092	.13	.18	.20	.29	.34	.45	30	50	62	68	
	•	•	•		0050	.46	-	-	.14	.20	.28	.30	.44	.51	.67	32	50	60	66	
	•	•	•		0067	.53	-	-	.19	.26	.37	.40	.59	.68	.90	35	50	60	66	
	•	•	•		01	.66	-	.19	.28	.39	.56	.60	.88	1.0	1.3	37	50	59	65	
	•	•	•		015	.81	-	.29	.42	.59	.84	.90	1.3	1.5	2.0	38	50	58	64	
	•	•	•		02	.89	-	.38	.56	.79	1.1	1.2	1.8	2.0	2.7	39	50	57	63	

Other body types may be available. Contact your sales engineer for further information.

Highlighted column shows the rated pressure.



QUICK-CHANGE NOZZLES: UNIJET® VEEJET®

FLAT SPRAY

PERFORMANCE DATA

METRIC UNITS

PERFORMANCE DATA
STANDARD ANGLE SPRAY TIPS: 13802, TPU, 58102 AND 49803

Spray Angle at 3 bar	UniJet Tip Type				Capacity Size	Equiv. Orifice Dia. (mm)	Flow Rate Capacity (liters per minute)										Spray Angle (°)			
	13802	TPU	58102	49803			0.4 bar	0.7 bar	1.5 bar	3 bar	6 bar	7 bar	15 bar	20 bar	35 bar	1.5 bar	3 bar	6 bar	15 bar	
50°	•	•	•		025	.99	.36	.48	.70	.99	1.4	1.5	2.2	2.5	3.4	40	50	57	63	
	•	•	•		03	1.1	.43	.57	.84	1.2	1.7	1.8	2.6	3.1	4.0	40	50	56	62	
	•	•	•		035	1.2	.50	.67	.98	1.4	2.0	2.1	3.1	3.6	4.7	40	50	56	61	
	•	•	•		04	1.3	.58	.76	1.1	1.6	2.2	2.4	3.5	4.1	5.4	42	50	56	61	
	•	•	•		05	1.4	.72	.95	1.4	2.0	2.8	3.0	4.4	5.1	6.7	44	50	56	61	
	•	•	•		06	1.5	.86	1.1	1.7	2.4	3.4	3.6	5.3	6.1	8.1	45	50	56	60	
	•	•	•		07	1.7	1.0	1.3	2.0	2.8	3.9	4.2	6.2	7.1	9.4	45	50	56	60	
	•	•	•		075	1.7	1.1	1.4	2.1	3.0	4.2	4.5	6.6	7.6	10.1	45	50	55	60	
	•	•	•		08	1.8	1.2	1.5	2.2	3.2	4.5	4.8	7.1	8.2	10.8	45	50	55	60	
	•	•	•		09	1.9	1.3	1.7	2.5	3.6	5.0	5.4	7.9	9.2	12.1	45	50	55	59	
	•	•		•	10	2.0	1.4	1.9	2.8	3.9	5.6	6.0	8.8	10.2	13.5	45	50	55	59	
	•	•		•	13	2.3	1.9	2.5	3.6	5.1	7.3	7.8	11.5	13.3	17.5	45	50	55	59	
	•	•		•	15	2.5	2.2	2.9	4.2	5.9	8.4	9.0	13.2	15.3	20	45	50	55	59	
	•	•		•	20	2.8	2.9	3.8	5.6	7.9	11.2	12.1	17.7	20	27	45	50	55	59	
	•	•		•	30	3.4	4.3	5.7	8.4	11.8	16.8	18.1	26	31	40	45	50	55	59	
	•	•		•	40	3.8	5.8	7.6	11.2	15.8	22	24	35	41	54	46	50	54	59	
	•	•		•	50	4.4	7.2	9.5	14.0	19.7	28	30	44	51	67	46	50	54	59	
	•	•		•	60	4.8	8.6	11.4	16.8	24	34	36	53	61	81	46	50	54	59	
	•	•		•	70	5.2	10.1	13.3	19.5	28	39	42	62	71	94	46	50	54	59	
	40°	•	•	•		0017	.28	-	-	.047	.067	.095	.10	.15	.17	.23	21	40	54	61
•		•	•		0025	.33	-	-	.070	.099	.14	.15	.22	.25	.34	22	40	53	60	
•		•	•		0033	.38	-	-	.092	.13	.18	.20	.29	.34	.45	22	40	53	60	
•		•	•		0050	.46	-	-	.14	.20	.28	.30	.44	.51	.67	22	40	53	60	
•		•	•		0067	.53	-	-	.19	.26	.37	.40	.59	.68	.90	24	40	53	60	
•		•	•		01	.66	-	-	.28	.39	.56	.60	.88	1.0	1.3	26	40	52	59	
•		•	•		015	.81	-	-	.42	.59	.84	.90	1.3	1.5	2.0	27	40	52	59	
•		•	•		02	.89	-	.38	.56	.79	1.1	1.2	1.8	2.0	2.7	29	40	51	58	
•		•	•		025	.99	-	.48	.70	.99	1.4	1.5	2.2	2.5	3.4	29	40	51	58	
•		•	•		03	1.1	-	.57	.84	1.2	1.7	1.8	2.6	3.1	4.0	30	40	50	57	
•		•	•		04	1.3	-	.76	1.1	1.6	2.2	2.4	3.5	4.1	5.4	30	40	50	56	
•		•	•		05	1.4	-	.95	1.4	2.0	2.8	3.0	4.4	5.1	6.7	31	40	49	55	
•		•	•		055	1.5	-	1.0	1.5	2.2	3.1	3.3	4.9	5.6	7.4	31	40	49	55	
•		•	•		06	1.6	-	1.1	1.7	2.4	3.4	3.6	5.3	6.1	8.1	31	40	49	55	
•		•	•		07	1.7	1.0	1.3	2.0	2.8	3.9	4.2	6.2	7.1	9.4	31	40	49	55	
•		•	•		08	1.8	1.2	1.5	2.2	3.2	4.5	4.8	7.1	8.2	10.8	31	40	47	53	
•		•	•		09	1.9	1.3	1.7	2.5	3.6	5.0	5.4	7.9	9.2	12.1	32	40	45	48	
•		•		•	10	2.0	1.4	1.9	2.8	3.9	5.6	6.0	8.8	10.2	13.5	32	40	45	48	
•		•		•	11	2.1	1.6	2.1	3.1	4.3	6.1	6.6	9.7	11.2	14.8	32	40	45	48	
•		•		•	12	2.2	1.7	2.3	3.4	4.7	6.7	7.2	10.6	12.2	16.2	32	40	45	48	
•	•		•	13	2.3	1.9	2.5	3.6	5.1	7.3	7.8	11.5	13.3	17.5	32	40	45	48		
•	•		•	15	2.5	2.2	2.9	4.2	5.9	8.4	9.0	13.2	15.3	20	32	40	45	48		
•	•		•	20	2.8	2.9	3.8	5.6	7.9	11.2	12.1	17.7	20	27	32	40	45	48		

Other body types may be available. Contact your sales engineer for further information.

Highlighted column shows the rated pressure.



METRIC UNITS

PERFORMANCE DATA
STANDARD ANGLE SPRAY TIPS: 13802, TPU, 58102 AND 49803

Spray Angle at 3 bar	UniJet Tip Type				Capacity Size	Equiv. Orifice Dia. (mm)	Flow Rate Capacity (liters per minute)										Spray Angle (°)			
	13802	TPU	58102	49803			0.4 bar	0.7 bar	1.5 bar	3 bar	6 bar	7 bar	15 bar	20 bar	35 bar	1.5 bar	3 bar	6 bar	15 bar	
40°	●	●		●	25	3.1	3.6	4.8	7.0	9.9	14.0	15.1	22	25	34	32	40	45	48	
	●	●		●	30	3.4	4.3	5.7	8.4	11.8	16.8	18.1	26	31	40	33	40	45	48	
	●	●		●	40	3.9	5.8	7.6	11.2	15.8	22	24	35	41	54	34	40	45	48	
	●	●		●	50	4.4	7.2	9.5	14.0	19.7	28	30	44	51	67	35	40	45	48	
	●	●		●	60	4.8	8.6	11.4	16.8	24	34	36	53	61	81	35	40	45	48	
	●	●		●	70	5.2	10.1	13.3	19.5	28	39	42	62	71	94	35	40	45	48	
25°	●	●	●		0017	.28	-	-	-	.067	.095	.10	.15	.17	.23	-	25	35	47	
	●	●	●		0025	.33	-	-	-	.099	.14	.15	.22	.25	.34	-	25	35	45	
	●	●	●		0033	.38	-	-	-	.13	.18	.20	.29	.34	.45	-	25	34	44	
	●	●	●		0050	.46	-	-	-	.20	.28	.30	.44	.51	.67	-	25	34	43	
	●	●	●		0067	.53	-	-	-	.26	.37	.40	.59	.68	.90	-	25	34	42	
	●	●	●		01	.66	-	-	.28	.39	.56	.60	.88	1.0	1.3	14	25	34	42	
	●	●	●		015	.81	-	-	.42	.59	.84	.90	1.3	1.5	2.0	15	25	34	41	
	●	●	●		02	.89	-	-	.56	.79	1.1	1.2	1.8	2.0	2.7	15	25	33	40	
	●	●	●		03	1.1	-	-	.84	1.2	1.7	1.8	2.6	3.1	4.0	15	25	33	40	
	●	●	●		04	1.3	-	.76	1.1	1.6	2.2	2.4	3.5	4.1	5.4	16	25	32	39	
	●	●	●		05	1.4	-	.95	1.4	2.0	2.8	3.0	4.4	5.1	6.7	16	25	32	39	
	●	●	●		055	1.5	-	1.0	1.5	2.2	3.1	3.3	4.9	5.6	7.4	16	25	32	39	
	●	●	●		06	1.6	-	1.1	1.7	2.4	3.4	3.6	5.3	6.1	8.1	17	25	31	38	
	●	●	●		07	1.7	-	1.3	2.0	2.8	3.9	4.2	6.2	7.1	9.4	17	25	31	38	
	●	●	●		08	1.8	-	1.5	2.2	3.2	4.5	4.8	7.1	8.2	10.8	17	25	31	38	
	●	●	●		09	1.9	-	1.7	2.5	3.6	5.0	5.4	7.9	9.2	12.1	17	25	31	38	
	●	●		●	10	2.0	-	1.9	2.8	3.9	5.6	6.0	8.8	10.2	13.5	18	25	31	37	
	●	●		●	13	2.3	-	2.5	3.6	5.1	7.3	7.8	11.5	13.3	17.5	18	25	31	37	
	●	●		●	15	2.5	-	2.9	4.2	5.9	8.4	9.0	13.2	15.3	20	18	25	31	37	
	●	●		●	20	2.8	-	3.8	5.6	7.9	11.2	12.1	17.7	20	27	19	25	31	37	
●	●		●	30	3.4	4.3	5.7	8.4	11.8	16.8	18.1	26	31	40	20	25	30	36		
●	●		●	40	3.9	5.8	7.6	11.2	15.8	22	24	35	41	54	21	25	29	35		
●	●		●	50	4.4	7.2	9.5	14.0	19.7	28	30	44	51	67	21	25	29	35		
●	●		●	60	4.8	8.6	11.4	16.8	24	34	36	53	61	81	22	25	29	35		
●	●		●	70	5.2	10.1	13.3	19.5	28	39	42	62	71	94	22	25	29	35		
15°	●	●	●		0017	.28	-	-	-	.067	.095	.10	.15	.17	.23	-	15	30	37	
	●	●	●		0025	.33	-	-	-	.099	.14	.15	.22	.25	.34	-	15	28	34	
	●	●	●		0033	.38	-	-	-	.13	.18	.20	.29	.34	.45	-	15	27	32	
	●	●	●		0050	.46	-	-	-	.20	.28	.30	.44	.51	.67	-	15	26	30	
	●	●	●		0067	.53	-	-	-	.26	.37	.40	.59	.68	.90	-	15	25	29	
	●	●	●		01	.66	-	-	-	.39	.56	.60	.88	1.0	1.3	-	15	24	28	
	●	●	●		015	.81	-	-	-	.59	.84	.90	1.3	1.5	2.0	-	15	23	27	
	●	●	●		02	.89	-	-	.56	.79	1.1	1.2	1.8	2.0	2.7	6	15	22	27	
	●	●	●		03	1.1	-	-	.84	1.2	1.7	1.8	2.6	3.1	4.0	6	15	22	27	
	●	●	●		04	1.3	-	-	1.1	1.6	2.2	2.4	3.5	4.1	5.4	7	15	21	26	
	●	●	●		05	1.4	-	-	1.4	2.0	2.8	3.0	4.4	5.1	6.7	7	15	21	26	
	●	●	●		055	1.5	-	-	1.5	2.2	3.1	3.3	4.9	5.6	7.4	7	15	21	26	

Other body types may be available. Contact your sales engineer for further information.
Highlighted column shows the rated pressure.



QUICK-CHANGE NOZZLES: UNIJET® VEEJET®

FLAT SPRAY

PERFORMANCE DATA

METRIC UNITS

PERFORMANCE DATA
STANDARD ANGLE SPRAY TIPS: 13802, TPU, 58102 AND 49803

Spray Angle at 3 bar	UniJet Tip Type				Capacity Size	Equiv. Orifice Dia. (mm)	Flow Rate Capacity (liters per minute)										Spray Angle (°)			
	13802	TPU	58102	49803			0.4 bar	0.7 bar	1.5 bar	3 bar	6 bar	7 bar	15 bar	20 bar	35 bar	1.5 bar	3 bar	6 bar	15 bar	
15°	•	•	•		06	1.6	-	-	1.7	2.4	3.4	3.6	5.3	6.1	8.1	8	15	21	26	
	•	•	•		07	1.7	-	-	2.0	2.8	3.9	4.2	6.2	7.1	9.4	8	15	21	26	
	•	•	•		08	1.8	-	-	2.2	3.2	4.5	4.8	7.1	8.2	10.8	9	15	20	25	
	•	•	•		09	1.9	-	-	2.5	3.6	5.0	5.4	7.9	9.2	12.1	9	15	20	25	
	•	•		•	10	2.0	-	-	2.8	3.9	5.6	6.0	8.8	10.2	13.5	10	15	19	24	
	•	•		•	11	2.1	-	2.1	3.1	4.3	6.1	6.6	9.7	11.2	14.8	10	15	19	24	
	•	•		•	12	2.2	1.7	2.3	3.4	4.7	6.7	7.2	10.6	12.2	16.2	10	15	19	24	
	•	•		•	15	2.5	2.2	2.9	4.2	5.9	8.4	9.0	13.2	15.3	20	10	15	19	24	
	•	•		•	20	2.8	2.9	3.8	5.6	7.9	11.2	12.1	17.7	20	27	10	15	19	23	
	•	•		•	30	3.4	4.3	5.7	8.4	11.8	16.8	18.1	26	31	40	10	15	19	21	
	•	•		•	40	3.9	5.8	7.6	11.2	15.8	22	24	35	41	54	10	15	18	21	
	•	•		•	50	4.4	7.2	9.5	14.0	19.7	28	30	44	51	67	11	15	18	21	
	•	•		•	60	4.8	8.6	11.4	16.8	24	34	36	53	61	81	11	15	18	21	
•	•		•	70	5.2	10.1	13.3	19.5	28	39	42	62	71	94	11	15	18	21		
0°	•	•			0009	.20	.013	.017	.025	.036	.050	.054	.079	.092	.12	0 (solid stream)				
	•	•			0012	.25	.017	.023	.034	.047	.067	.072	.11	.12	.16					
	•	•			0019	.30	.027	.036	.053	.075	.11	.11	.17	.19	.26					
	•	•			0021	.33	.030	.040	.059	.083	.12	.13	.19	.21	.28					
	•	•			0033	.41	.048	.063	.092	.13	.18	.20	.29	.34	.45					
	•	•			0050	.48	.072	.095	.14	.20	.28	.30	.44	.51	.67					
	•	•			0067	.58	.097	.13	.19	.26	.37	.40	.59	.68	.90					
	•	•			01	.71	.14	.19	.28	.39	.56	.60	.88	1.0	1.3					
	•	•			015	.86	.22	.29	.42	.59	.84	.90	1.3	1.5	2.0					
	•	•			02	.99	.29	.38	.56	.79	1.1	1.2	1.8	2.0	2.7					
	•	•			03	1.2	.43	.57	.84	1.2	1.7	1.8	2.6	3.1	4.0					
	•	•			04	1.4	.58	.76	1.1	1.6	2.2	2.4	3.5	4.1	5.4					
	•	•			045	1.5	.65	.86	1.3	1.8	2.5	2.7	4.0	4.6	6.1					
	•	•			05	1.6	.72	.95	1.4	2.0	2.8	3.0	4.4	5.1	6.7					
	•	•			055	1.7	.79	1.0	1.5	2.2	3.1	3.3	4.9	5.6	7.4					
	•	•			06	1.7	.86	1.1	1.7	2.4	3.4	3.6	5.3	6.1	8.1					
	•	•			065	1.8	.94	1.2	1.8	2.6	3.6	3.9	5.7	6.6	8.8					
	•	•			07	1.9	1.0	1.3	2.0	2.8	3.9	4.2	6.2	7.1	9.4					
	•	•			08	2.0	1.2	1.5	2.2	3.2	4.5	4.8	7.1	8.2	10.8					
	•	•			09	2.1	1.3	1.7	2.5	3.6	5.0	5.4	7.9	9.2	12.1					
•	•			10	2.2	1.4	1.9	2.8	3.9	5.6	6.0	8.8	10.2	13.5						
•	•			11	2.3	1.6	2.1	3.1	4.3	6.1	6.6	9.7	11.2	14.8						
•	•			12	2.4	1.7	2.3	3.4	4.7	6.7	7.2	10.6	12.2	16.2						
•	•			15	2.7	2.2	2.9	4.2	5.9	8.4	9.0	13.2	15.3	20						
•	•			20	3.1	2.9	3.8	5.6	7.9	11.2	12.1	17.7	20	27						
•	•			30	3.6	4.3	5.7	8.4	11.8	16.8	18.1	26	31	40						
•	•			40	4.1	5.8	7.6	11.2	15.8	22	24	35	41	54						

Other body types may be available. Contact your sales engineer for further information.
Highlighted column shows the rated pressure.

ASSEMBLY DIMENSIONS AND WEIGHTS:

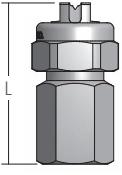
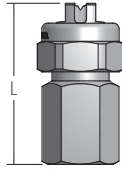
Nozzle	Tip/Body Type	Conn. Size (in.)	L (mm)	Hex. (in.)	Net Weight (kg)
	TPU + T (female) TPU + TT (male)	1/8, 1/4, 3/8, 1/2	40.9	13/16	0.06
	13802 + T (female) 13802 TT (male) +	1/8, 1/4, 3/8, 1/2	48.0	13/16	0.06

Based on the largest/heaviest version of each type.

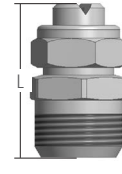
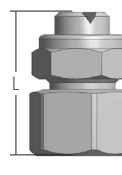
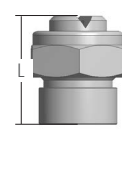
Nozzle	Tip/Body Type	Conn. Size/Type (in.)	L (mm)	Hex. (in.)	Net Weight (kg)
	49803/58102 + 50868	1/4	37.6	3/4	0.07
	49803/58102 + 50869	1/4	37.3	3/4	0.06
	49803/58102 + 49801	Butt Weld	32.5	-	0.06

SPRAY TIP DIMENSIONS:

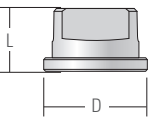
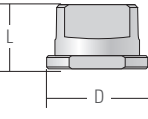
Spray Tip	Spray Tip Type	L (mm)	D (Dia.) (mm)	Wrench Flats (mm)	Dovetail Flats (mm)
	TPU	9.5	15.1	7.9	-
	13802	9.5	15.1	7.9	12.6

Based on the largest/heaviest version of each type.

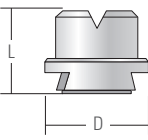
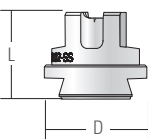
Spray Tip	Spray Tip Type	L (mm)	D (Dia.) (mm)	Wrench Flats (mm)	Dovetail Flats (mm)
	49803	11.7	14.7	-	10.4
	58102	12.5	14.7	7.9	10.4

Based on the largest/heaviest version of each type.
 Dovetail spray tips can be used on a variety of body types.

**PERFORMANCE DATA
STANDARD ANGLE SPRAY TIPS: 45824**

Nozzle Type/ Conn. Size (in.)		Orifice Dia. Nom. (mm)	Capacity Size	Flow Rate Capacity (liters per minute)*
45824				7 bar
1-1/4	1-1/2			
●	●	19.1	750	227
●	●	22.3	875	303
●	●	25.4	1000	378
●	●	28.6	1125	492
●	●	31.8	1250	568

*Reference flow rates measured at 7 bar using water. Field studies indicate black liquor flow rates are approximately 50% of water flow rates. Spray angle 130°
Highlighted column shows the rated pressure.

**PERFORMANCE DATA
STANDARD ANGLE SPRAY: U**

Spray Angle at 40 psi	Nozzle Type/ Conn. Size (in.)	Capacity Size	Equiv. Orifice Dia. (mm)	Flow Rate Capacity (liters per minute)									Spray Angle (°)			
	U			0.4 bar	0.7 bar	1.5 bar	3 bar	6 bar	7 bar	15 bar	20 bar	35 bar	1.5 bar	3 bar	6 bar	15 bar
	1-1/4															
65°	●	500	13.4	72	95	140	197	279	302	441	510	674	60	65	66	68
	●	500	13.4	72	95	140	197	279	302	441	510	674	49	50	51	54
50°	●	750	16.4	108	143	209	296	419	452	662	765	1011	49	50	51	53
	●	1000	19.0	144	191	279	395	558	603	883	1019	1349	49	50	51	53
25°	●	500	13.4	72	95	140	197	279	302	441	510	674	24	25	26	29
	●	750	16.4	108	143	209	296	419	452	662	765	1011	24	25	26	28
	●	1000	19.0	144	191	279	395	558	603	883	1019	1349	24	25	26	28
15°	●	500	13.4	72	95	140	197	279	302	441	510	674	14	15	16	17
	●	1000	19.0	144	191	279	395	558	603	883	1019	1349	14	15	16	17

Highlighted column shows the rated pressure.

DIMENSIONS AND WEIGHTS

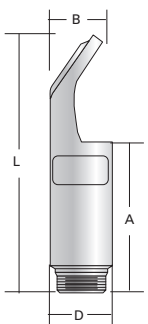
Nozzle	Nozzle Type	Conn. Size (in.)	L (mm)	A (mm)	B (mm)	D (Dia.) (mm)	Net Weight (kg)
	45824	1-1/4	210	123	35.3	50.8	2.1

Based on the largest/heaviest version of each type.

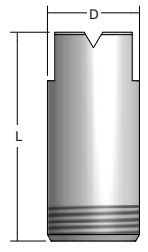
Nozzle	Nozzle Type	Conn. Size (in.)	L (mm)	D (Dia.) (mm)	Net Weight (kg)
	U	1-1/4	95.3	42.9	0.57

Based on the largest/heaviest version of each type.

PERFORMANCE DATA

FLAT SPRAY

QUICK-CHANGE NOZZLES: QUICKJET® AND UNIJET®

METRIC UNITS

PERFORMANCE DATA
WIDE ANGLE SPRAY: QSTK, QTKA

Conn. Size (in.)	Quick FloodJet Tip Type		Capacity Size	Equiv. Orifice Dia. (mm)	Flow Rate Capacity (liters per minute)						Spray Angle (°)			
	QSTK	QTKA			0.2 bar	0.5 bar	0.7 bar	1.5 bar	2 bar	3 bar	4 bar	0.5 bar	1.5 bar	4 bar
1/8, 1/4, 3/8, 1/2	●		.25	.43	–	–	–	.14	.16	.20	.23	–	83	117
	●	●	.50	.58	–	–	–	.28	.32	.39	.46	–	89	122
	●	●	.75	.74	–	–	.29	.42	.48	.59	.68	–	106	125
	●	●	1	.84	–	–	.38	.56	.64	.79	.91	–	109	128
	●	●	1.5	1.0	–	.48	.57	.84	.97	1.2	1.4	73	108	125
	●	●	2	1.2	–	.64	.76	1.1	1.3	1.6	1.8	83	113	129
	●	●	2.5	1.3	–	.81	.95	1.4	1.6	2.0	2.3	98	122	133
	●	●	3	1.4	–	.97	1.1	1.7	1.9	2.4	2.7	86	112	126
	●	●	4	1.7	–	1.3	1.5	2.2	2.6	3.2	3.6	97	123	132
	●	●	5	1.9	1.0	1.6	1.9	2.8	3.2	3.9	4.6	114	128	142
		●	7.5	2.3	1.5	2.4	2.9	4.2	4.8	5.9	6.8	101	119	134
		●	10	2.7	2.0	3.2	3.8	5.6	6.4	7.9	9.1	115	133	145
		●	12	2.9	2.4	3.9	4.6	6.7	7.7	9.5	10.9	128	139	153
		●	15	3.3	3.1	4.8	5.7	8.4	9.7	11.8	13.7	98	113	123
		●	18	3.6	3.7	5.8	6.9	10.1	11.6	14.2	16.4	106	120	131
	●	20	3.8	4.1	6.4	7.6	11.2	12.9	15.8	18.2	110	122	133	
3/8, 1/2		●	30	4.6	6.1	9.7	11.4	16.8	19.3	24	27	100	110	121
		●	40	5.3	8.2	12.9	15.3	22	26	32	36	111	126	136
		●	45	5.6	9.2	14.5	17.2	25	29	36	41	115	130	140
		●	60	6.5	12.2	19.3	23	34	39	47	55	120	134	142

Highlighted column shows the rated pressure.

PERFORMANCE DATA
WIDE ANGLE SPRAY: TK

Conn. Size (in.)	UniJet® FloodJet Tip Type	Capacity Size	Equiv. Orifice Dia. (mm)	Flow Rate Capacity (liters per minute)						Spray Angle (°)			
	TK			0.2 bar	0.5 bar	0.7 bar	1.5 bar	2 bar	3 bar	4 bar	0.5 bar	1.5 bar	4 bar
1/4	●	.50	.58	–	–	–	.28	.32	.39	.46	–	89	122
	●	.75	.74	–	–	.29	.42	.48	.59	.68	–	106	125
	●	1	.84	–	–	.38	.56	.64	.79	.91	–	109	128
	●	1.5	1.0	–	.48	.57	.84	.97	1.2	1.4	73	108	125
	●	2	1.2	–	.64	.76	1.1	1.3	1.6	1.8	83	113	129
	●	2.5	1.3	–	.81	.95	1.4	1.6	2.0	2.3	98	122	133
	●	3	1.4	–	.97	1.1	1.7	1.9	2.4	2.7	86	112	126
	●	4	1.7	–	1.3	1.5	2.2	2.6	3.2	3.6	97	123	132
	●	5	1.9	1.0	1.6	1.9	2.8	3.2	3.9	4.6	114	128	142

Other body types may be available. Contact your sales engineer for further information.

Highlighted column shows the rated pressure.



FLAT SPRAY
QUICK-CHANGE NOZZLES: QUICKJET® AND UNIJET®

PERFORMANCE DATA

METRIC UNITS

PERFORMANCE DATA
WIDE ANGLE SPRAY: TK

Conn. Size (in.)	UniJet® FloodJet Tip Type	Capacity Size	Equiv. Orifice Dia. (mm)	Flow Rate Capacity (liters per minute)							Spray Angle (°)		
	TK			0.2 bar	0.5 bar	0.7 bar	1.5 bar	2 bar	3 bar	4 bar	0.5 bar	1.5 bar	4 bar
1/4	●	7.5	2.3	1.5	2.4	2.9	4.2	4.8	5.9	6.8	101	119	134
	●	10	2.7	2.0	3.2	3.8	5.6	6.4	7.9	9.1	115	133	145
	●	12	2.9	2.4	3.9	4.6	6.7	7.7	9.5	10.9	128	139	153
	●	15	3.3	3.1	4.8	5.7	8.4	9.7	11.8	13.7	98	113	123
	●	18	3.6	3.7	5.8	6.9	10.1	11.6	14.2	16.4	106	120	131
	●	20	3.8	4.1	6.4	7.6	11.2	12.9	15.8	18.2	110	122	133
	●	24	4.1	4.9	7.7	9.2	13.4	15.5	19.0	22	115	131	144
	●	30	4.6	6.1	9.7	11.4	16.8	19.3	24	27	100	110	121
	●	40	5.3	8.2	12.9	15.3	22	26	32	36	111	126	136
	●	50	5.9	10.2	16.1	19.1	28	32	39	46	117	131	140

Other body types may be available. Contact your sales engineer for further information.

Highlighted column shows the rated pressure.

DIMENSIONS AND WEIGHTS

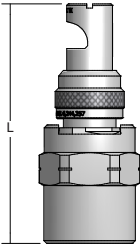
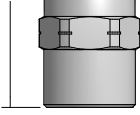
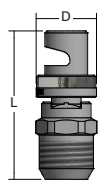
Nozzle	Nozzle Type	Conn. Size/Type (in.)	L (mm)	Hex. (in.)	D (Dia.) (mm)	Net Weight (kg)
	QJA + QTKA	1/8, 1/4, 3/8, 1/2 female	64.3	1	—	0.14
	QJJA + QTKA	1/8, 1/4, 3/8, 1/2 male	61.9	7/8	—	0.13
	QJJS + QSTK	1/8, 1/4, 3/8, 1/2 male	37.3	9/16	15.1	0.04

Based on the largest/heaviest version of each type.

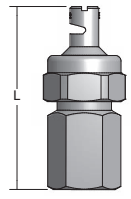
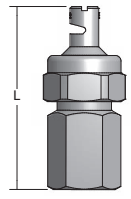
Nozzle	Nozzle Type	Conn. Size/Type (in.)	L (mm)	Hex. (in.)	D (Dia.) (mm)	Net Weight (kg)
	T + TK	1/4 female	50.8	13/16	—	0.07
	TT + TK	1/4 male	50.8	13/16	—	0.06

Based on the largest/heaviest version of each type.

PERFORMANCE DATA
WIDE ANGLE SPRAY: K, 11499, 13063

Nozzle Type			Conn. Size (in.)						Capacity Size	Equiv. Orifice Dia. (mm)	Flow Rate Capacity (liters per minute)							Spray Angle (°)		
K	11499	13063	1/8	1/4	3/8	1/2	3/4	1			0.2 bar	0.5 bar	0.7 bar	1.5 bar	2 bar	3 bar	4 bar	0.5 bar	1.5 bar	4 bar
•			•						.25	.43	-	-	.14	.16	.20	.23	-	83	117	
•			•						.50	.58	-	-	.28	.32	.39	.46	-	89	122	
•			•						.75	.74	-	-	.29	.42	.48	.59	.68	-	106	125
•			•						1	.84	-	-	.38	.56	.64	.79	.91	-	103	128
•			•						1.5	1.0	-	.48	.57	.84	.97	1.2	1.4	73	103	125
•	•		•	•					2	1.2	-	.64	.76	1.1	1.3	1.6	1.8	83	113	129
•	•		•	•					2.5	1.3	-	.81	.95	1.4	1.6	2.0	2.3	98	122	133
•	•		•	•					3	1.4	-	.97	1.1	1.7	1.9	2.4	2.7	86	112	126
•	•	•	•						4	1.7	-	1.3	1.5	2.2	2.6	3.2	3.6	97	123	132
•	•	•	•	•					5	1.9	1.0	1.6	1.9	2.8	3.2	3.9	4.6	114	128	142
•	•	•	•	•					7.5	2.3	1.5	2.4	2.9	4.2	4.8	5.9	6.8	101	119	134
•	•	•	•	•					10	2.7	2.0	3.2	3.8	5.6	6.4	7.9	9.1	115	133	145
•			•	•					12	2.9	2.4	3.9	4.6	6.7	7.7	9.5	10.9	128	139	153
•	•		•	•					15	3.3	3.1	4.8	5.7	8.4	9.7	11.8	13.7	98	113	123
•	•		•	•					18	3.6	3.7	5.8	6.9	10.1	11.6	14.2	16.4	106	120	131
•			•	•					20	3.8	4.1	6.4	7.6	11.2	12.9	15.8	18.2	110	122	133
•			•						22	3.9	4.5	7.1	8.4	12.3	14.2	17.4	20	113	125	136
•			•						24	4.1	4.9	7.7	9.2	13.4	15.5	19.0	22	115	131	144
•			•						27	4.4	5.5	8.7	10.3	15.1	17.4	21	25	119	135	148
•				•					30	4.6	6.1	9.7	11.4	16.8	19.3	24	27	100	110	121
•				•					35	5.0	7.1	11.3	13.3	19.5	23	28	32	105	118	128
•				•	•				40	5.3	8.2	12.9	15.3	22	26	32	36	111	126	136
•				•					45	5.6	9.2	14.5	17.2	25	29	36	41	115	130	140
•					•				50	5.9	10.2	16.1	19.1	28	32	39	46	117	131	140
•					•				60	6.5	12.2	19.3	23	34	39	47	55	120	134	142
•					•				70	7.0	14.3	23	27	39	45	55	64	123	137	146
•					•				80	7.5	16.3	26	31	45	52	63	73	127	138	149
•						•			90	8.1	18.3	29	34	50	58	71	82	120	133	140
•						•			100	8.5	20	32	38	56	64	79	91	123	136	145
•						•			110	8.9	22	35	42	61	71	87	100	125	138	148
•						•			120	9.3	24	39	46	67	77	95	109	129	143	150
•						•			140	10.0	29	45	53	78	90	111	128	118	127	135
•						•			160	10.7	33	52	61	89	103	126	146	121	130	137
•						•			180	11.4	37	58	69	101	116	142	164	124	133	139
•						•			210	12.3	43	68	80	117	135	166	191	128	139	145
•							•		300	14.8	61	97	114	168	193	237	274	110	128	135
•							•		450	18.0	92	145	172	251	290	355	410	118	132	138

Highlighted column shows the rated pressure.

DIMENSIONS AND WEIGHTS

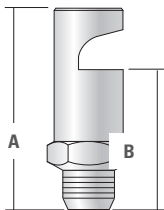

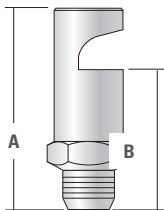
Nozzle	Nozzle Type	Conn. Size/Type (in.)	A (mm)	B (mm)	Hex. (in.)	Net Weight (kg)	
	K	1/8 male	32.5	18.6	7/16	.01	
		1/4 male	34.1	21.8	9/16	.03	
		3/8 male	44.5	25.4	11/16	.06	
		1/2 male	50.8	30.2	7/8	.11	
		3/4 male	65.1	39.7	1-1/2	.40	
		1 male	90.1	55.6	1-7/8	.91	
	11499		1/8 male	40.5	28.2	9/16	.01
	13063		1/8 male	40.5	31.8	7/16	.01

Based on the largest/heaviest version of each type.

METRIC UNITS

PLACING YOUR ORDER

Call your local spray expert for application assistance or to place an order.



PERFORMANCE DATA

FLAT SPRAY
FLATJET® NOZZLES

METRIC UNITS

PERFORMANCE DATA
NARROW ANGLE SPRAY: P

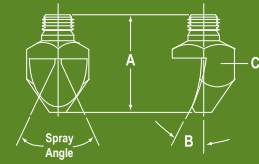

Spray Angle at 3 bar	Nozzle Type P	Conn. Size (in.)					Capacity Size	Equiv. Orifice Dia. (mm)	Flow Rate Capacity (liters per minute)						Spray Angle (°)			Dimensions			
		1/8	1/4	3/8	1/2	3/4			1 bar	1.5 bar	3 bar	6 bar	7 bar	10 bar	1 bar	3 bar	7 bar	A Length (mm)	B Deflection Angle (°)	C Bar Size (mm sq.)	Net Weight (kg)
50°	•		•				05	1.3	1.1	1.4	2.0	2.8	3.0	3.6	33	50	60	31	60	15.9	.03
	•		•				10	1.9	2.3	2.8	3.9	5.6	6.0	7.2	34	50	60	31	60	15.9	.03
	•		•	•			25	3.0	5.7	7.0	9.9	14.0	15.1	18.0	42	50	59	41.5	42	19.1	.09
	•		•	•			40	3.8	9.1	11.2	15.8	22	24	29	39	50	60	47	45	19.1	.09
	•			•			60	4.6	13.7	16.8	24	34	36	43	42	50	53	55	37	25.4	.14
	•			•			100	5.9	23	28	39	56	60	72	43	50	55	72	40	31.8	.33
	•			•			125	6.6	28	35	49	70	75	90	38	50	59	72	38	31.8	.31
	•			•			160	7.5	36	45	63	89	96	115	44	50	55	72	37	31.8	.31
	•			•			200	8.4	46	56	79	112	121	144	46	50	53	72	32	31.8	.31
40°	•			•			40	3.8	9.1	11.2	15.8	22	24	29	31	40	50	60.5	35	22.2	.14
	•			•			50	4.2	11.4	14.0	19.7	28	30	36	31	40	49	63.5	33	25.4	.20
	•			•			60	4.6	13.7	16.8	24	34	36	43	32	40	49	72	33	25.4	.23
	•			•			70	5.0	16.0	19.5	28	39	42	50	32	40	49	75.5	29	25.4	.26
	•			•			80	5.3	18.2	22	32	45	48	58	32	40	48	77	26	25.4	.26
	•			•			90	5.6	21	25	36	50	54	65	34	40	44	77	28	25.4	.23
	•			•			100	5.9	23	28	39	56	60	72	35	40	44	86.5	28	25.4	.26
35°	•	•					04	1.2	.91	1.1	1.6	2.2	2.4	2.9	20	35	41	23	40	11.1	.01
	•		•				10	1.9	2.3	2.8	3.9	5.6	6.0	7.2	18	35	39	36.5	36	15.9	.06
	•		•	•			20	2.7	4.6	5.6	7.9	11.2	12.1	14.4	24	35	40	42	30	19.1	.06
	•			•			25	3.0	5.7	7.0	9.9	14.0	15.1	18.0	24	35	39	49	28	19.1	.09
	•			•			30	3.3	6.8	8.4	11.8	16.8	18.1	22	26	35	41	52.5	28	19.1	.09
	•			•			40	3.8	9.1	11.2	15.8	22	24	29	28	35	38	58	26	22.2	.11
	•			•			50	4.2	11.4	14.0	19.7	28	30	36	31	35	38	63.5	23	22.2	.14
	•				•		60	4.6	13.7	16.8	24	34	36	43	29	35	39	73	27	25.4	.23
	•				•		80	5.3	18.2	22	32	45	48	58	26	35	40	81	24	25.4	.26
	•				•		100	5.9	23	28	39	56	60	72	26	35	40	89	19	25.4	.26
	•					•	160	7.5	36	45	63	89	96	115	26	35	40	114	23	31.8	.57
	•					•	200	8.4	46	56	79	112	121	144	25	35	40	122	22	31.8	.57

Highlighted column shows the rated pressure.



**PERFORMANCE DATA
NARROW ANGLE SPRAY: P**

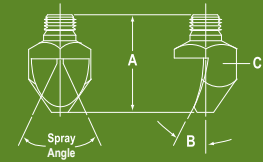

Spray Angle at 3 bar	Nozzle Type	Conn. Size (in.)					Capacity Size	Equiv. Orifice Dia. (mm)	Flow Rate Capacity (liters per minute)						Spray Angle (°)			Dimensions			
		1/8	1/4	3/8	1/2	3/4			1 bar	1.5 bar	3 bar	6 bar	7 bar	10 bar	1 bar	3 bar	7 bar	A Length (mm)	B Deflection Angle (°)	C Bar Size (mm sq.)	Net Weight (kg)
25°	●		●				40	3.8	9.1	11.2	15.8	22	24	29	15	25	34	65	25	19.1	.11
	●		●				10	1.9	–	2.8	3.9	5.6	6.0	7.2	–	15	23	47.5	22	15.9	.06
15°	●		●				20	2.7	–	5.6	7.9	11.2	12.1	14.4	–	15	19	54	19	15.9	.06
	●			●			30	3.3	6.8	8.4	11.8	16.8	18.1	22	6	15	24	72	25	19.1	.11
	●			●			40	3.8	9.1	11.2	15.8	22	24	29	8	15	21	92	18	22.2	.23
	●			●			50	4.2	11.4	14.0	19.7	28	30	36	9	15	20	90.5	15	22.2	.17
	●				●		60	4.6	13.7	16.8	24	34	36	43	10	15	19	125	14	25.4	.34
	●				●		80	5.3	18.2	22	32	45	48	58	11	15	18	130	14	25.4	.34
	●					●	100	5.9	23	28	39	56	60	72	11	15	18	131	14	25.4	.40
	●						200	8.4	46	56	79	112	121	144	12	15	18	165	14	31.8	.73

Highlighted column shows the rated pressure.

**PERFORMANCE DATA
NARROW ANGLE SPRAY: 115220**

Spray Angle at 3 bar	Nozzle Type	Conn. Size (in.)	Capacity Size	Equiv. Orifice Dia. (mm)	Flow Rate Capacity (liters per minute)						Spray Angle (°)			Dimensions		
					1 bar	1.5 bar	3 bar	5.5 bar	7 bar	10 bar	15 bar	40 bar	100 bar	A Length (mm)	B Deflection Angle (°)	C Bar Size (mm sq.)
35°	●	●	20	2.7	4.6	5.6	7.9	10.7	12.1	14.4	42	50	59	62	45	22.2
	●	●	30	3.3	6.8	8.4	11.8	16.0	18.1	22	42	50	59	62	45	22.2
	●	●	40	3.8	9.1	11.2	15.8	21	24	29	39	50	60	62	45	22.2
50°	●	●	20	2.7	4.6	5.6	7.9	10.7	12.1	14.4	24	35	40	73	28	22.2
	●	●	30	3.3	6.8	8.4	11.8	16.0	18.1	22	26	35	41	73	28	22.2
	●	●	40	3.8	9.1	11.2	15.8	21.0	24	29	28	35	38	73	28	22.2

Highlighted column shows the rated pressure.

PERFORMANCE DATA
NARROW ANGLE SPRAY: QLPA

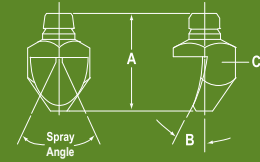

Spray Angle at 3 bar	Nozzle Type	Conn. Size (in.)		Capacity Size	Equiv. Orifice Dia. (mm)	Capacity (liters per minute)										Spray Angle (°)			Dimensions			
		3/8	1/2			1 bar	1.5 bar	2 bar	3 bar	4 bar	6 bar	7 bar	10 bar	15 psi	40 psi	100 psi	A Length (mm)	B Deflection Angle (°)	C Bar Size (mm sq.)	Net Weight (kg)		
50°	●	●	●	60	4.6	13.7	16.8	19.3	24	27	34	36	43	42	50	53	81	37	25.4	.23		
				125	6.6	28	35	40	49	57	70	75	90	38	50	59	98	38	32	.24		
35°	●	●	●	60	4.6	13.7	16.8	19.3	24	27	34	36	43	29	35	39	98	27	25.4	.23		
				80	5.3	18.2	22	26	32	36	45	48	58	26	35	40	106	24	32	.24		

Highlighted column shows the rated pressure.

DIMENSIONS

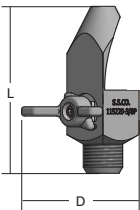
Nozzle	Nozzle Type	Conn. Size/Type (in.)	L (mm)	D (Dia.) (mm)
	115220	3/8	72.6	51.1

Based on the largest/heaviest version of each type.

PERFORMANCE DATA
STANDARD ANGLE SPRAY: AX, BX

Conn. Size (in.)	Nozzle Type		Capacity Size	Inlet Dia. Nom. (mm)	Orifice Dia. Nom. (mm)	Flow Rate Capacity (liters per minute)										Spray Angle (°)		
	AX	BX				0.2 bar	0.4 bar	0.7 bar	1 bar	1.5 bar	2 bar	3 bar	4 bar	6 bar	7 bar	0.7 bar	1.5 bar	6 bar
1/8	●	●	.5	.79	1.2	-	-	.19	.23	.28	.32	.39	.46	.56	.60	39	58	69
	●	●	1	1.6	1.6	-	-	.38	.46	.56	.64	.79	.91	1.1	1.2	41	64	76
	●	●	2	2.0	2.0	-	.58	.76	.91	1.1	1.3	1.6	1.8	2.2	2.4	52	61	69
	●	●	3	2.4	2.4	-	.86	1.1	1.4	1.7	1.9	2.4	2.7	3.4	3.6	52	64	77
	●	●	5	3.2	3.2	1.0	1.4	1.9	2.3	2.8	3.2	3.9	4.6	5.6	6.0	56	67	76
	●	●	8	4.0	4.0	1.6	2.3	3.1	3.6	4.5	5.2	6.3	7.3	8.9	9.6	56	65	70
	●	●	10	4.4	4.4	2.0	2.9	3.8	4.6	5.6	6.4	7.9	9.1	11.2	12.1	55	65	72
1/4	●	●	1	1.6	1.6	-	-	.38	.46	.56	.64	.79	.91	1.1	1.2	47	53	67
	●	●	2	2.0	2.0	-	-	.76	.91	1.1	1.3	1.6	1.8	2.2	2.4	56	62	71
	●	●	3	2.4	2.4	-	.86	1.1	1.4	1.7	1.9	2.4	2.7	3.4	3.6	51	65	78
	●	●	5	3.6	3.6	1.0	1.4	1.9	2.3	2.8	3.2	3.9	4.6	5.6	6.0	63	73	79
	●	●	8	4.0	4.0	1.6	2.3	3.1	3.6	4.5	5.2	6.3	7.3	8.9	9.6	61	69	73
	●	●	10	4.8	4.4	2.0	2.9	3.8	4.6	5.6	6.4	7.9	9.1	11.2	12.1	63	70	74
	●	●	15	5.9	5.2	3.1	4.3	5.7	6.8	8.4	9.7	11.8	13.7	16.8	18.1	63	71	72
3/8	●	●	5	3.6	3.2	1.0	1.4	1.9	2.3	2.8	3.2	3.9	4.6	5.6	6.0	64	73	79
	●	●	8	4.4	4.0	1.6	2.3	3.1	3.6	4.5	5.2	6.3	7.3	8.9	9.6	62	70	74
	●	●	10	5.2	4.4	2.0	2.9	3.8	4.6	5.6	6.4	7.9	9.1	11.2	12.1	64	72	75
	●	●	15	5.9	5.6	3.1	4.3	5.7	6.8	8.4	9.7	11.8	13.7	16.8	18.1	64	72	74
	●	●	20	7.1	6.4	4.1	5.8	7.6	9.1	11.2	12.9	15.8	18.2	22	24	63	70	74
	●	●	25	7.5	7.5	5.1	7.2	9.5	11.4	14.0	16.1	19.7	23	28	30	63	70	74
	●	●	30	8.3	7.9	6.1	8.6	11.4	13.7	16.8	19.3	24	27	34	36	63	70	74
1/2	●	●	25	9.5	6.4	5.1	7.2	9.5	11.4	14.0	16.1	19.7	23	28	30	63	66	71
	●	●	30	9.5	7.5	6.1	8.6	11.4	13.7	16.8	19.3	24	27	34	36	67	71	75
	●	●	40	9.5	9.1	8.2	11.5	15.3	18.2	22	26	32	36	45	48	72	76	78
	●	●	50	9.5	11.1	10.2	14.4	19.1	23	28	32	39	46	56	60	74	79	82
	●	●	60	9.5	13.1	12.2	17.3	23	27	34	39	47	55	67	72	77	82	86
3/4	●	●	40	12.7	7.9	8.2	11.5	15.3	18.2	22	26	32	36	45	48	70	73	74
	●	●	50	12.7	9.5	10.2	14.4	19.1	23	28	32	39	46	56	60	72	75	77
	●	●	60	12.7	11.1	12.2	17.3	23	27	34	39	47	55	67	72	74	76	79
	●	●	70	12.7	12.7	14.3	20	27	32	39	45	55	64	78	84	76	79	83
	●	●	80	12.7	14.3	16.3	23	31	36	45	52	63	73	89	96	78	82	84
	●	●	90	12.7	14.7	18.3	26	34	41	50	58	71	82	101	109	81	84	84
	●	●	100	12.7	15.9	20	29	38	46	56	64	79	91	112	121	83	86	86
	●	●	110	12.7	17.1	22	32	42	50	61	71	87	100	123	133	85	88	88
	●	●	120	12.7	18.3	24	35	46	55	67	77	95	109	134	145	87	90	90

Intermediate capacities: Caps are interchangeable for in-between capacities within each pipe size group. Request Data Sheets 3055, 3986 and 3987.
Spray dimension data: Request Data Sheets 15350 and 15362.

Highlighted column shows the rated pressure.



PERFORMANCE DATA
STANDARD ANGLE SPRAY: CX

Conn. Size (in.)	Nozzle Type CX	Capacity Size	Inlet Dia. Nom. (mm)	Orifice Dia. Nom. (mm)	Flow Rate Capacity (liters per minute)												Spray Angle (°)		
					0.2 bar	0.3 bar	0.4 bar	0.5 bar	0.7 bar	1 bar	1.5 bar	2 bar	3 bar	4 bar	6 bar	7 bar	0.5 bar	1.5 bar	4 bar
1	●	7	17.5	11.5	17.1	21	24	27	32	38	47	54	66	76	93	101	64	65	66
	●	8	17.5	12.7	19.5	24	28	31	36	44	53	62	76	87	107	115	65	66	67
	●	9	17.5	14.3	22	27	31	35	41	49	60	69	85	98	120	130	66	67	69
	●	10	17.5	15.5	24	30	34	39	46	54	67	77	94	109	133	144	67	69	71
	●	12	17.5	17.1	29	36	41	46	55	65	80	92	113	131	160	173	70	73	75
	●	15	17.5	20.6	37	45	52	58	68	82	100	116	142	163	200	216	76	79	81
1-1/4	●	10	21.4	14.3	24	30	34	39	46	54	67	77	94	109	133	144	65	67	67
	●	12	21.4	16.3	29	36	41	46	55	65	80	92	113	131	160	173	68	70	71
	●	14	21.4	18.3	34	42	48	54	64	76	93	108	132	153	187	202	71	73	75
	●	16	21.4	20.2	39	48	55	62	73	87	107	123	151	174	214	231	74	75	77
	●	20	21.4	24.2	49	60	69	77	91	109	133	154	189	218	267	288	76	77	79
1-1/2	●	16	27.8	17.5	39	48	55	62	73	87	107	123	151	174	214	231	64	67	69
	●	20	27.8	21.8	49	60	69	77	91	109	133	154	189	218	267	288	69	72	74
	●	25	27.8	25.8	61	75	86	96	114	136	167	193	236	272	334	360	72	74	76
	●	30	27.8	28.6	73	90	103	116	137	163	200	231	283	327	400	432	74	76	78
2	●	30	36.5	23.8	73	90	103	116	137	163	200	231	283	327	400	432	66	67	70
	●	35	36.5	27.0	85	104	121	135	160	191	234	270	330	381	467	505	68	70	73
	●	40	36.5	30.2	97	119	138	154	182	218	267	308	378	436	534	577	70	72	75
	●	45	36.5	32.9	110	134	155	173	205	245	300	347	425	490	601	649	72	74	78
	●	50	36.5	36.1	122	149	172	193	228	272	334	385	472	545	667	721	74	77	82
	●	60	36.5	39.7	146	179	207	231	274	327	400	462	566	654	801	865	77	79	84
2-1/2	●	60	47.6	36.1	146	179	207	231	274	327	400	462	566	654	801	865	67	68	71
	●	70	47.6	40.5	171	209	241	270	319	381	467	539	661	763	934	1009	69	71	74
	●	80	47.6	44.1	195	239	276	308	365	436	534	616	755	872	1068	1153	71	73	77
	●	90	47.6	47.6	219	269	310	347	410	490	601	694	849	981	1201	1297	73	75	80
	●	100	47.6	50.8	244	298	345	385	456	545	667	771	944	1090	1335	1442	77	79	83

Highlighted column shows the rated pressure.

PLACING YOUR ORDER

Call your local spray expert for application assistance or to place an order.



**PERFORMANCE DATA
STANDARD ANGLE SPRAY: CF, CRC**

Conn. Size (in.)	Nozzle Type		Capacity Size	Inlet Dia. Nom. (mm)	Orifice Dia. Nom. (mm)	Flow Rate Capacity (liters per minute)										Spray Angle (°)		
	CF	CRC				0.2 bar	0.4 bar	0.5 bar	0.7 bar	1.5 bar	2 bar	3 bar	4 bar	6 bar	7 bar	0.5 bar	1.5 bar	4 bar
1-1/4	●	●	10-45	21.4	13.1	24	34	39	46	67	77	94	109	133	144	45	49	52
	●	●	12-45	21.4	14.3	29	41	46	55	80	92	113	131	160	173	45	49	51
	●	●	14-45	21.4	16.7	34	48	54	64	93	108	132	153	187	202	45	48	51
	●	●	16-45	21.4	19.1	39	55	62	73	107	123	151	174	214	231	45	48	50
	●	●	20-45	21.4	22.2	49	69	77	91	133	154	189	218	267	288	45	47	49
2	●	●	30-45	36.5	23.8	73	103	116	137	200	231	283	327	400	432	45	49	52
	●	●	35-45	36.5	27.0	85	121	135	160	234	270	330	381	467	505	45	49	51
	●	●	40-45	36.5	30.2	97	138	154	182	267	308	378	436	534	577	45	48	50
	●	●	45-45	36.5	32.1	110	155	173	205	300	347	425	490	601	649	45	48	50
	●	●	50-45	36.5	34.9	122	172	193	228	334	385	472	545	667	721	45	47	49
	●	●	55-45	36.5	36.9	134	190	212	251	367	424	519	599	734	793	45	47	49
3	●	●	70	57.2	34.9	171	241	270	319	467	539	661	763	934	1009	65	66	69
	●	●	85	57.2	40.1	207	293	327	388	567	655	802	926	1134	1225	67	68	71
	●	●	100	57.2	44.5	244	345	385	456	667	771	944	1090	1335	1442	69	72	74
	●	●	120	57.2	52.4	292	414	462	547	801	925	1133	1308	1602	1730	71	73	77
	●	●	140	57.2	58.7	341	482	539	638	934	1079	1321	1526	1869	2018	73	75	80
	●	●	70-45	57.2	34.9	171	241	270	319	467	539	661	763	934	1009	45	49	52
	●	●	85-45	57.2	40.1	207	293	327	388	567	655	802	926	1134	1225	45	49	51
	●	●	100-45	57.2	44.5	244	345	385	456	667	771	944	1090	1335	1442	45	48	51
	●	●	120-45	57.2	51.2	292	414	462	547	801	925	1133	1308	1602	1730	45	48	50
	●	●	140-45	57.2	58.7	341	482	539	638	934	1079	1321	1526	1869	2018	45	47	49
4	●	●	150	79.4	50.8	366	517	578	684	1001	1156	1416	1635	2002	2162	66	67	70
	●	●	175	79.4	59.1	426	603	674	798	1168	1349	1652	1907	2336	2523	68	70	71
	●	●	200	79.4	68.3	487	689	771	912	1335	1541	1888	2180	2669	2883	70	72	74
	●	●	225	79.4	74.6	548	775	867	1026	1502	1734	2123	2452	3003	3244	72	74	77
	●	●	250	79.4	82.6	609	862	963	1140	1668	1926	2359	2724	3337	3604	74	76	81
	●	●	275	79.4	92.1	670	948	1060	1254	1835	2119	2595	2997	3670	3964	78	80	83
	●	●	150-45	79.4	50.8	366	517	578	684	1001	1156	1416	1635	2002	2162	45	49	52
	●	●	175-45	79.4	59.1	426	603	674	798	1168	1349	1652	1907	2336	2523	45	49	51
	●	●	200-45	79.4	68.3	487	689	771	912	1335	1541	1888	2180	2669	2883	45	48	51
	●	●	225-45	79.4	74.6	548	775	867	1026	1502	1734	2123	2452	3003	3244	45	48	50
	●	●	250-45	79.4	82.6	609	862	963	1140	1668	1926	2359	2724	3337	3604	45	47	49
	6	●	●	250	124	62.3	609	862	963	1140	1668	1926	2359	2724	3337	3604	65	67
●		●	300	124	69.9	731	1034	1156	1368	2002	2312	2831	3269	4004	4325	66	68	70
●		●	350	124	76.2	853	1206	1349	1596	2336	2697	3303	3814	4671	5046	68	70	72
●		●	400	124	82.6	975	1378	1541	1824	2669	3082	3775	4359	5339	5767	70	73	75
●		●	450	124	88.1	1097	1551	1734	2051	3003	3468	4247	4904	6006	6487	72	75	77
●		●	500	124	97.2	1218	1723	1926	2279	3337	3853	4719	5449	6673	7208	74	76	79
●		●	550	124	108	1340	1895	2119	2507	3670	4238	5191	5994	7341	7929	76	79	83
●		●	625	124	130	1523	2154	2408	2849	4171	4816	5899	6811	8342	9010	78	81	86
●		●	440-65	124	88.1	1072	1516	1695	2006	2936	3391	4153	4795	5873	6343	60	61	62
●		●	550-65	124	108	1340	1895	2119	2507	3670	4238	5191	5994	7341	7929	64	65	66
●	●	625-65	124	130	1523	2154	2408	2849	4171	4816	5899	6811	8342	9010	65	66	67	



PERFORMANCE DATA

HOLLOW CONE
WHIRLJET® NOZZLES

METRIC UNITS

PERFORMANCE DATA
STANDARD ANGLE SPRAY: D

Conn. Size (in.)	Nozzle Type D	Capacity Size	Inlet Dia. Nom. (mm)	Orifice Dia. Nom. (mm)	Flow Rate Capacity (liters per minute)												Spray Angle (°)		
					0.2 bar	0.3 bar	0.4 bar	0.5 bar	0.7 bar	1 bar	1.5 bar	2 bar	3 bar	4 bar	6 bar	7 bar	0.7 bar	1.5 bar	4 bar
1/2	●	3	11.1	7.9	7.3	9.0	10.3	11.6	13.7	16.3	20	23	28	33	40	43	62	65	67
	●	4	11.1	9.9	9.7	11.9	13.8	15.4	18.2	22	27	31	38	44	53	58	68	71	73
	●	5	11.1	11.9	12.2	14.9	17.2	19.3	23	27	33	39	47	54	67	72	74	77	80
	●	7	11.1	13.9	17.1	21	24	27	32	38	47	54	66	76	93	101	77	80	83
3/4	●	4	14.3	9.1	9.7	11.9	13.8	15.4	18.2	22	27	31	38	44	53	58	63	66	67
	●	5	14.3	10.7	12.2	14.9	17.2	19.3	23	27	33	39	47	54	67	72	67	69	70
	●	6	14.3	12.3	14.6	17.9	21	23	27	33	40	46	57	65	80	86	71	73	77
	●	7	14.3	13.9	17.1	21	24	27	32	38	47	54	66	76	93	101	73	75	80
	●	10	14.3	16.7	24	30	34	39	46	54	67	77	94	109	133	144	77	80	84

Highlighted column shows the rated pressure.

PERFORMANCE DATA
STANDARD ANGLE SPRAY: AP, LAP, LBP

Nozzle Type/ Conn. Size (in.)					Capacity Size	Inlet Dia. Nom. (mm)	Orifice Dia. Nom. (mm)	Flow Rate Capacity (liters per minute)												Spray Angle (°)		
AP		LAP		LBP				0.2 bar	0.4 bar	0.5 bar	0.7 bar	1.5 bar	2 bar	3 bar	4 bar	6 bar	7 bar	0.7 bar	1.5 bar	6 bar		
1/4	3/8	3/8	1/2	3/8																		
●	●				2	2.0	2.0	–	.57	.64	.75	1.1	1.3	1.6	1.8	2.2	2.4	53	70	80		
●	●				2-3	2.0	2.4	–	.69	.77	.89	1.3	1.5	1.9	2.2	2.7	2.9	61	76	83		
●	●				2-5	2.0	2.8	–	.80	.90	1.1	1.6	1.8	2.2	2.6	3.1	3.4	63	81	90		
●	●				2-8	2.0	3.6	–	.98	1.1	1.2	1.8	2.1	2.6	3.0	3.7	4.0	71	87	95		
●	●				2-10	2.0	4.4	–	1.1	1.2	1.4	2.0	2.3	2.8	3.3	4.0	4.3	72	94	104		
●	●				2-15	2.0	5.2	–	1.2	1.3	1.5	2.2	2.5	3.1	3.6	4.4	4.7	77	100	111		
●	●				2-20	2.0	6.0	–	1.3	1.4	1.7	2.5	2.8	3.5	4.0	4.9	5.3	81	103	113		
●	●				3-2	2.4	2.0	–	.75	.84	1.0	1.5	1.7	2.1	2.4	2.9	3.1	58	67	76		
●	●				3	2.4	2.4	–	.87	.97	1.2	1.7	1.9	2.4	2.7	3.3	3.6	55	79	80		
●	●				3-5	2.4	2.8	–	1.1	1.2	1.4	2.0	2.3	2.8	3.3	4.0	4.3	72	82	86		
●	●				3-8	2.4	3.6	–	1.3	1.4	1.7	2.5	2.8	3.5	4.0	4.9	5.3	73	88	92		
●	●				3-10	2.4	4.4	–	1.4	1.5	1.8	2.7	3.1	3.8	4.4	5.4	5.8	81	94	97		
●	●				3-15	2.4	5.2	–	1.6	1.8	2.1	3.1	3.5	4.3	5.0	6.1	6.6	83	93	100		
●	●				3-20	2.4	6.0	–	1.8	2.0	2.4	3.5	4.0	4.9	5.7	6.9	7.5	90	100	107		
●	●				5-2	3.6	2.0	–	–	–	1.4	2.0	2.3	2.8	3.3	4.0	4.3	49	61	67		
●	●				5-3	3.6	2.4	–	–	1.3	1.6	2.3	2.6	3.2	3.7	4.6	4.9	57	68	69		
●	●				5	3.6	2.8	–	1.4	1.6	2.2	2.8	3.2	3.9	4.6	5.6	6.0	70	75	79		
●	●				5-8	3.6	3.6	–	1.7	1.9	2.3	3.3	3.9	4.7	5.5	6.7	7.2	80	78	82		
●	●				5-10	3.6	4.4	–	2.0	2.2	2.5	3.7	4.3	5.3	6.1	7.5	8.1	80	87	89		
●	●				5-15	3.6	5.2	–	2.3	2.6	3.1	4.5	5.2	6.3	7.3	8.9	9.6	83	91	95		
●	●				5-20	3.6	6.0	–	2.5	2.8	3.3	4.8	5.5	6.8	7.8	9.6	10.4	88	98	102		
●	●				8-5	4.4	2.8	–	1.7	1.9	2.2	3.3	3.9	4.7	5.5	6.7	7.2	60	68	71		

Highlighted column shows the rated pressure.



PERFORMANCE DATA
STANDARD ANGLE SPRAY: AP, LAP, LBP

Nozzle Type/ Conn. Size (in.)					Capacity Size	Inlet Dia. Nom. (mm)	Orifice Dia. Nom. (mm)	Flow Rate Capacity (liters per minute)										Spray Angle (°)		
AP		LAP		LBP				0.2 bar	0.4 bar	0.5 bar	0.7 bar	1.5 bar	2 bar	3 bar	4 bar	6 bar	7 bar	0.7 bar	1.5 bar	6 bar
1/4	3/8	3/8	1/2	3/8																
●	●				8	4.4	3.6	1.6	2.3	2.6	3.1	4.5	5.2	6.3	7.3	8.9	9.6	65	72	74
●	●				8-10	4.4	4.4	1.9	2.7	3.0	3.5	5.2	6.1	7.4	8.6	10.5	11.3	73	81	81
●	●				8-15	4.4	5.2	2.2	3.1	3.5	4.1	6.1	7.1	8.7	10.0	12.3	13.3	78	84	87
●	●				8-20	4.4	6.0	2.4	3.4	3.9	4.6	6.7	7.7	9.5	10.9	13.4	14.5	84	89	92
●	●				10-5	4.8	2.8	–	–	2.1	2.5	3.6	4.2	5.1	5.9	7.3	7.8	55	64	67
●	●				10-8	4.8	3.6	–	2.5	2.8	3.3	4.8	5.5	6.8	7.8	9.6	10.4	60	64	66
●	●				10	4.8	4.4	2.0	2.8	3.2	3.8	5.6	6.4	7.9	9.1	11.2	12.1	70	76	75
●	●				10-15	4.8	5.2	2.4	3.4	3.9	4.6	6.7	7.7	9.5	10.9	13.4	14.5	76	81	79
●	●				10-20	4.8	6.0	2.9	4.1	4.5	5.3	7.8	9.0	11.1	12.8	15.6	16.9	78	85	98
●	●				15-5	6.0	2.8	–	–	–	2.9	4.2	4.9	6.0	6.9	8.5	9.2	52	65	60
●	●				15-8	6.0	3.6	–	–	3.2	3.8	5.6	6.4	7.9	9.1	11.2	12.1	55	68	64
●	●				15-10	6.0	4.4	–	3.5	3.9	4.6	6.7	7.7	9.5	10.9	13.4	14.5	65	75	71
●	●				15	6.0	5.2	3.1	4.4	4.8	5.7	8.4	9.7	11.8	13.7	16.7	18.1	70	72	75
●	●				15-20	6.0	6.0	3.5	4.9	5.5	6.5	9.5	11.0	13.4	15.5	19.0	21	78	80	82
		●			20-5	6.4	3.2	–	–	–	3.1	4.6	5.4	6.6	7.6	9.3	10.0	33	40	55
		●			20-8	6.4	4.4	–	–	3.5	4.1	6.1	7.1	8.7	10.0	12.3	13.3	40	47	60
		●			20-10	6.4	4.8	–	4.0	4.5	5.3	7.8	9.0	11.1	12.8	15.6	16.9	39	55	65
		●			20-15	6.4	6.0	3.7	5.2	5.8	6.9	10.0	11.6	14.2	16.4	20	22	55	63	68
		●			20	6.4	6.4	4.1	5.8	6.4	7.6	11.2	12.9	15.8	18.2	22	24	59	66	70
		●			20-25	6.4	7.5	5.1	7.2	8.1	9.6	14.0	16.1	19.7	23	28	30	60	73	77
		●			20-40	6.4	9.1	5.9	8.3	9.3	11.0	16.2	18.7	23	26	32	35	80	82	86
		●			20-50	6.4	11.1	7.1	10.0	11.3	13.4	19.5	23	28	32	39	42	83	90	97
		●			20-60	6.4	13.1	8.2	11.6	12.9	15.3	22	26	32	36	45	48	86	94	99
		●			25-8	7.1	4.4	–	–	–	4.6	6.7	7.7	9.5	10.9	13.4	14.5	27	42	57
		●			25-10	7.1	4.8	3.1	4.4	4.8	5.7	8.4	9.7	11.7	13.7	16.7	18.1	35	50	59
		●			25-15	7.1	6.0	3.9	5.5	6.1	7.2	10.6	12.2	15.0	17.3	21	23	44	57	64
		●			25-20	7.1	6.4	4.5	6.4	7.1	8.4	12.3	14.2	17.4	20	25	27	53	63	68
		●			25	7.1	7.5	5.1	7.2	8.1	9.6	14.0	16.1	19.7	23	28	30	60	70	74
		●			25-40	7.1	9.1	6.5	9.2	10.3	12.2	17.9	21	25	29	36	39	69	73	79
		●			25-50	7.1	11.1	8.0	11.3	12.6	14.9	22	25	31	36	44	47	76	81	85
		●			25-60	7.1	13.1	9.2	13.0	14.5	17.2	25	29	36	41	50	54	83	86	92
		●	●	●	40-8	9.1	4.4	–	–	–	5.7	8.4	9.7	11.8	13.7	16.7	18.1	30	41	48
		●	●	●	40-10	9.1	4.8	–	–	5.8	6.9	10.0	11.6	14.2	16.4	20	22	34	45	53
		●	●	●	40-15	9.1	6.0	4.9	6.9	7.7	9.1	13.4	15.5	18.9	22	27	29	44	48	57
		●	●	●	40-20	9.1	6.4	5.5	7.8	8.7	10.3	15.1	17.4	21	25	30	33	45	52	59
		●	●	●	40-25	9.1	7.5	6.5	9.2	10.3	12.2	17.9	21	25	29	36	39	48	56	61
		●	●	●	40	9.1	9.1	8.2	11.6	12.9	15.3	22	26	32	36	45	48	67	71	73
		●	●	●	40-50	9.1	11.1	10.2	14.4	16.1	19.0	28	32	39	46	56	60	68	80	84
		●	●	●	40-50.1	9.1	10.7	10.2	14.4	16.1	19.0	28	32	39	46	56	60	40	47	50
		●	●	●	40-60	9.1	13.1	12.2	17.3	19.3	23	33	39	47	55	67	72	80	86	90

Highlighted column shows the rated pressure.



PERFORMANCE DATA
STANDARD ANGLE SPRAY: BD

Conn. Size (in.)	Nozzle Type BD	Capacity Size	Inlet Dia. Nom. (mm)	Orifice Dia. Nom. (mm)	Flow Rate Capacity (liters per minute)											Spray Angle (°)		
					0.2 bar	0.4 bar	0.5 bar	0.7 bar	1 bar	1.5 bar	2 bar	3 bar	4 bar	6 bar	7 bar	0.5 bar	1.5 bar	6 bar
3/8	●	2	2.4	2.0	.41	.58	.64	.76	.91	1.1	1.3	1.6	1.8	2.2	2.4	51	60	70
	●	3	2.4	2.4	.61	.86	.97	1.1	1.4	1.7	1.9	2.4	2.7	3.4	3.6	52	64	77
	●	5	2.8	3.2	1.0	1.4	1.6	1.9	2.3	2.8	3.2	3.9	4.6	5.6	6.0	56	67	76
	●	8	4.0	4.0	1.6	2.3	2.6	3.1	3.6	4.5	5.2	6.3	7.3	8.9	9.6	56	65	70
	●	10	4.0	4.4	2.0	2.9	3.2	3.8	4.6	5.6	6.4	7.9	9.1	11.2	12.1	55	65	72
	●	20-10	4.0*	4.4	–	4.0	4.5	5.3	6.4	7.8	9.0	11.1	12.8	15.6	16.9	61	65	67
1/2	●	5	3.2	3.6	1.0	1.4	1.6	1.9	2.3	2.8	3.2	3.9	4.6	5.6	6.0	63	73	79
	●	8	4.0	4.0	1.6	2.3	2.6	3.1	3.6	4.5	5.2	6.3	7.3	8.9	9.6	61	69	73
	●	10	4.4	4.4	2.0	2.9	3.2	3.8	4.6	5.6	6.4	7.9	9.1	11.2	12.1	63	70	74
	●	15	4.4*	5.2	3.1	4.3	4.8	5.7	6.8	8.4	9.7	11.8	13.7	16.8	18.1	60	67	70
	●	20	4.8*	6.0	4.1	5.8	6.4	7.6	9.1	11.2	12.9	15.8	18.2	22	24	63	65	69
	●	25	5.2*	7.1	5.1	7.2	8.1	9.5	11.4	14.0	16.1	19.7	23	28	30	59	63	68
3/4	●	5	3.6	3.2	1.0	1.4	1.6	1.9	2.3	2.8	3.2	3.9	4.6	5.6	6.0	64	73	79
	●	8	4.4	4.0	1.6	2.3	2.6	3.1	3.6	4.5	5.2	6.3	7.3	8.9	9.6	62	70	74
	●	10	5.2	4.4	2.0	2.9	3.2	3.8	4.6	5.6	6.4	7.9	9.1	11.2	12.1	64	72	75
	●	15	6.4	5.6	3.1	4.3	4.8	5.7	6.8	8.4	9.7	11.8	13.7	16.8	18.1	64	72	74
	●	20	7.1	6.4	4.1	5.8	6.4	7.6	9.1	11.2	12.9	15.8	18.2	22	24	63	70	74
	●	25	7.1	7.5	5.1	7.2	8.1	9.5	11.4	14.0	16.1	19.7	23	28	30	63	70	74
	●	50-50.3	7.1*	9.5	10.2	13.3	16.1	19.1	23	28	32	39	46	56	60	70	72	73
1-1/2	●	40	9.5*	7.9	8.2	11.5	12.9	15.3	18.2	22	26	32	36	45	48	70	73	74
	●	50	9.5*	9.5	10.2	13.3	16.1	19.1	23	28	32	39	46	56	60	72	75	77
	●	60	9.5*	11.1	12.2	17.3	19.3	23	27	34	39	47	55	67	72	74	76	79
	●	70	9.5*	12.7	14.3	20	23	27	32	39	45	55	64	78	84	76	79	83
	●	80	9.5*	14.3	16.3	23	26	31	36	45	52	63	73	89	96	78	82	84
	●	90	9.5*	14.7	18.3	26	29	34	41	50	58	71	82	101	109	81	84	84
	●	100	9.5*	15.9	20	29	32	38	46	56	64	79	91	112	121	83	86	86
	●	110	9.5*	17.1	22	32	35	42	50	61	71	87	100	123	133	85	88	88
	●	120	9.5*	18.3	24	35	39	46	55	67	77	95	109	134	145	87	90	90

*Dual inlets, each in diameter specified.

Highlighted column shows the rated pressure.



**PERFORMANCE DATA
STANDARD ANGLE SPRAY: BDM**

Conn. Size (in.)	Nozzle Type BDM	Capacity Size	Orifice Dia. Nom. (mm)	Flow Rate Capacity (liters per minute)								Spray Angle (°)		
				0.7 bar	1.5 bar	3 bar	7 bar	15 bar	20 bar	25 bar	35 bar	1.5 bar	7 bar	35 bar
3/8	●	2-0.5	1.2	–	–	.63	.96	1.4	1.6	1.8	2.2	–	52	45
	●	2-1	1.6	–	.61	.87	1.3	1.9	2.2	2.5	3.0	53	65	50
	●	2	2.0	.76	1.1	1.6	2.4	3.5	4.1	4.6	5.4	60	69	62
	●	3-2	2.0	.84	1.2	1.7	2.7	3.9	4.5	5.0	5.9	57	68	58
	●	3	2.4	1.1	1.7	2.4	3.6	5.3	6.1	6.8	8.1	64	75	64
	●	5	3.2	1.9	2.8	3.9	6.0	8.8	10.2	11.4	13.5	73	78	72
	●	10-2	2.0	1.3	2.0	2.8	4.2	6.2	7.1	8.0	9.4	30	46	40
	●	20-10	4.4	5.3	7.8	11.1	16.9	25	29	32	38	61	60	49

Maximum recommended operating pressure is 500 psi (34.5 bar).
Highlighted column shows the rated pressure.

PLACING YOUR ORDER

Call your local spray expert for application assistance or to place an order.



PERFORMANCE DATA

HOLLOW CONE
WHIRLJET® NOZZLES

METRIC UNITS

PERFORMANCE DATA
WIDE ANGLE SPRAY: AX-W, BX-W

Conn. Size (in.)	Nozzle Type		Capacity Size	Inlet Dia. Nom. (mm)	Orifice Dia. Nom. (mm)	Flow Rate Capacity (liters per minute)										Spray Angle (°)		
	AX-W	BX-W				0.4 bar	0.5 bar	0.7 bar	1 bar	1.5 bar	2 bar	3 bar	4 bar	6 bar	0.7 bar	1.5 bar	6 bar	
1/8	●	●	0.5-0.5W	.79	1.2	–	–	.19	.23	.28	.32	.39	.46	.56	103	117	98	
	●	●	1-1W	1.6	1.6	–	–	.39	.46	.56	.64	.79	.91	1.1	110	125	110	
	●	●	2-3W	2.0	2.8	–	.81	.97	1.1	1.4	1.6	2.0	2.3	2.8	114	114	97	
	●	●	3-3W	2.4	2.8	–	.97	1.2	1.4	1.7	1.9	2.4	2.7	3.3	114	114	97	
	●	●	3-5W	2.4	3.2	–	1.1	1.3	1.5	1.9	2.2	2.7	3.1	3.8	116	110	95	
	●	●	2-10W	2.0	4.4	–	1.3	1.6	1.9	2.3	2.6	3.2	3.7	4.6	130	135	120	
	●	●	5-5W	3.2	3.2	–	1.6	1.9	2.3	2.8	3.2	3.9	4.6	5.5	116	110	92	
	●	●	5-10W	3.2	4.4	1.9	2.1	2.5	3.0	3.6	4.2	5.1	5.9	7.3	126	121	95	
	●	●	8-10W	4.0	4.4	2.6	2.9	3.5	4.1	5.0	5.8	7.1	8.2	10.0	124	112	90	
1/4	●	●	1-1W	1.6	1.6	–	–	.39	.46	.56	.64	.79	.91	1.1	110	117	111	
	●	●	1-5W	1.6	3.2	–	–	.65	.77	.95	1.1	1.3	1.5	1.9	100	123	124	
	●	●	1-10W	1.6	4.4	–	–	.81	.96	1.2	1.4	1.7	1.9	2.3	140	144	139	
	●	●	1-15W	1.6	5.6	–	–	.93	1.1	1.3	1.5	1.9	2.2	2.7	105	128	132	
	●	●	2-5W	2.0	3.2	–	1.1	1.3	1.5	1.9	2.2	2.7	3.1	3.8	118	123	113	
	●	●	2-10W	2.0	4.4	–	1.3	1.6	1.9	2.3	2.6	3.2	3.7	4.6	138	136	126	
	●	●	5-5W	3.6	3.2	–	1.6	1.9	2.3	2.8	3.2	3.9	4.6	5.6	114	113	104	
	●	●	5-10W	3.6	4.4	1.9	2.1	2.5	3.0	3.6	4.2	5.1	5.9	7.3	130	130	119	
	●	●	5-15W	3.6	5.6	2.2	2.5	3.0	3.5	4.3	5.0	6.1	7.0	8.6	130	132	120	
	●	●	8-10W	4.0	4.4	2.6	2.9	3.5	4.1	5.0	5.8	7.1	8.2	10.0	129	122	103	
	●	●	10-10W	4.8	4.4	2.9	3.2	3.8	4.6	5.6	6.4	7.9	9.1	11.2	120	108	95	
	●	●	8-15W	4.0	5.6	3.1	3.5	4.2	5.0	6.1	7.1	8.7	10.0	12.3	129	122	107	
	●	●	10-15W	4.8	5.6	3.5	3.9	4.7	5.5	6.7	7.7	9.5	10.9	13.4	120	108	97	
	●	●	15-15W	6.0	5.6	4.3	4.8	5.7	6.8	8.4	9.7	11.8	13.7	16.7	101	95	88	
3/8	●	●	5-10W	3.6	4.4	1.9	2.1	2.5	3.0	3.6	4.2	5.1	5.9	7.3	130	123	102	
	●	●	5-15W	3.6	5.6	2.2	2.5	3.0	3.5	4.3	5.0	6.1	7.0	8.6	138	131	112	
	●	●	8-10W	4.4	4.4	2.6	2.9	3.5	4.1	5.0	5.8	7.1	8.2	10.0	122	110	96	
	●	●	10-10W	5.2	4.4	2.9	3.2	3.8	4.6	5.6	6.4	7.9	9.1	11.2	116	108	93	
	●	●	8-15W	4.4	5.6	3.1	3.5	4.2	5.0	6.1	7.1	8.7	10.0	12.3	133	120	105	
	●	●	10-15W	5.2	5.6	3.5	3.9	4.7	5.5	6.7	7.7	9.5	10.9	13.4	126	115	100	
	●	●	8-25W	4.4	7.5	3.8	4.2	5.0	5.9	7.3	8.4	10.3	11.9	14.5	122	118	109	
	●	●	10-20W	5.2	6.0	4.0	4.5	5.4	6.4	7.8	9.0	11.1	12.8	15.6	118	112	102	
	●	●	15-15W	6.0	5.6	4.3	4.8	5.7	6.8	8.4	9.7	11.8	13.7	16.7	116	106	95	
	●	●	15-20W	6.0	6.0	4.9	5.5	6.6	7.7	9.5	11.0	13.4	15.5	19.0	113	108	98	
	●	●	20-20W	7.1	6.0	5.7	6.4	7.6	9.1	11.2	12.9	15.8	18.2	22	106	102	95	
	●	●	15-30W	6.0	7.9	6.4	7.1	8.5	10.0	12.3	14.2	17.4	20	25	116	110	102	
	●	●	25-25W	7.5	7.5	7.2	8.1	9.7	11.4	14.0	16.1	19.7	23	28	105	100	93	
	●	●	25-30W	7.5	7.9	8.0	9.0	10.8	12.8	15.6	18.0	22	26	31	105	101	94	
1/2	●	●	50-50W	9.5	11.1	14.4	16.1	19.2	23	28	32	39	46	56	110	102	93	

Intermediate capacities: Caps are interchangeable for in-between capacities within each pipe size group. Request Data Sheets 3055, 3986 and 3987.
Spray dimension data: Request Data Sheets 15350 and 15362.

Highlighted column shows the rated pressure.



PERFORMANCE DATA
WIDE ANGLE SPRAY: LAP-W, LBP-W

Nozzle Type/ Conn. Size (in.)			Capacity Size	Inlet Dia. Nom. (mm)	Orifice Dia. Nom. (mm)	Flow Rate Capacity (liters per minute)										Spray Angle (°)		
LAP-W		LBP-W				0.2 bar	0.4 bar	0.5 bar	0.7 bar	1.5 bar	2 bar	3 bar	4 bar	6 bar	7 bar	0.5 bar	1.5 bar	6 bar
3/8	1/2	3/8																
●			20-8W	6.4	4.4	–	–	3.5	4.1	6.1	7.1	8.7	10.0	12.3	13.3	99	96	86
●			20-10W	6.4	4.8	–	3.2	4.5	5.3	7.8	9.0	11.1	12.8	15.6	16.9	101	98	88
●			20-15W	6.4	5.6	3.7	5.2	5.8	6.9	10.0	11.6	14.2	16.4	20	22	104	100	91
●			20-20W	6.4	6.4	4.1	5.8	6.4	7.6	11.2	12.9	15.8	18.2	22	24	106	101	93
●			20-25W	6.4	7.1	5.1	7.2	8.1	9.6	14.0	16.1	19.7	23	28	30	109	104	95
●			20-40W	6.4	8.7	5.9	8.3	9.3	11.0	16.2	18.7	23	26	32	35	110	107	98
●			20-50W	6.4	10.3	7.1	10.0	11.3	13.4	19.5	23	28	32	39	42	111	108	100
●			25-8W	7.1	4.4	–	–	–	4.6	6.7	7.7	9.5	10.9	13.4	14.5	–	89	78
●			25-10W	7.1	4.8	–	–	4.8	5.7	8.4	9.7	11.8	13.7	16.7	18.1	100	92	81
●			25-15W	7.1	5.6	–	4.3	6.1	7.2	10.6	12.2	15.0	17.3	21	23	102	96	85
●			25-20W	7.1	6.4	4.5	6.4	7.1	8.4	12.3	14.2	17.4	20	25	27	104	99	88
●			25-25W	7.1	7.1	5.1	7.2	8.1	9.6	14.0	16.1	19.7	23	28	30	107	102	91
●			25-40W	7.1	8.7	6.5	9.2	10.3	12.2	17.9	21	25	29	36	39	109	105	94
●			25-50W	7.1	10.3	8.0	11.3	12.6	14.9	22	25	31	36	44	47	110	108	99
●	●	●	40-10W	9.1	4.8	–	–	5.8	6.9	10.0	11.6	14.2	16.4	20	22	95	85	80
●	●	●	40-15W	9.1	5.6	4.9	6.9	7.7	9.1	13.4	15.5	18.9	22	27	29	97	88	82
●	●	●	40-20W	9.1	6.4	5.5	7.8	8.7	10.3	15.1	17.4	21	25	30	33	100	94	88
●	●	●	40-25W	9.1	7.1	6.5	9.2	10.3	12.2	17.9	21	25	29	36	39	103	97	91
●	●	●	40-40W	9.1	8.7	8.1	11.5	12.9	15.3	22	26	32	36	45	48	106	99	93
●	●	●	40-50W	9.1	10.3	10.2	14.4	16.1	19.0	28	32	39	46	56	60	109	101	96

Highlighted column shows the rated pressure.

PLACING YOUR ORDER

Call your local spray expert for application assistance or to place an order.

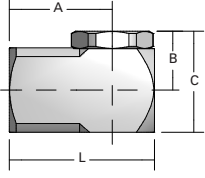
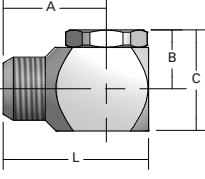
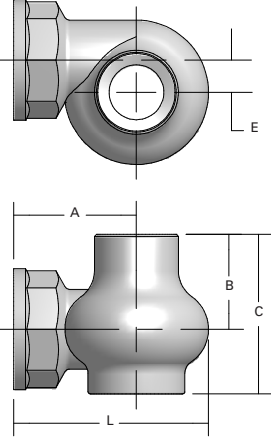
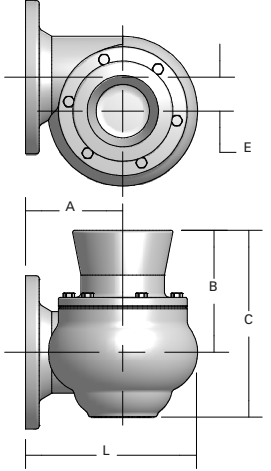

DIMENSIONS AND WEIGHTS

Nozzle	Nozzle Type	Conn. Size/Type (in.)	L (mm)	A (mm)	B (mm)	C (mm)	E (mm)	Net Weight (kg)
	AX AX-W	1/8 female	25.4	17.5	11.9	19.8	–	0.04
		1/4 female	31.8	22.2	13.5	23.0	–	0.08
		3/8 female	37.3	26.2	17.5	28.6	–	0.12
		1/2 female	49.2	34.9	21.4	39.8	–	0.25
		3/4 female	55.6	34.9	39.7	31.8	–	0.31
	BX BX-W	1/8 male	30.2	22.2	16.6	34.9	–	0.04
		1/4 male	34.9	25.4	13.5	39.7	–	0.07
		3/8 male	39.7	28.6	17.5	39.7	–	0.11
		1/2 male	49.2	34.9	21.4	49.2	–	0.20
		3/4 male	57.2	41.3	39.7	31.8	–	0.30
	CX	1 female	66.7	44.5	31.8	46.8	8.7	0.31
		1-1/4 female	77.8	52.4	33.3	55.6	11.1	0.57
		1-1/2 female	93.7	61.9	38.1	73.0	14.3	0.79
		2 female	115.1	93.7	53.6	93.7	18.3	1.36
		2-1/2 female	140.5	88.9	68.0	114.3	11.9	1.93
	CF	4 Flange	209.6	111.9	235.0	314.3	39.7	51.71
		6 Flange	311.2	174.6	220.7	338.1	61.9	57.15

Based on the largest/heaviest version of each type.

DIMENSIONS AND WEIGHTS

METRIC UNITS

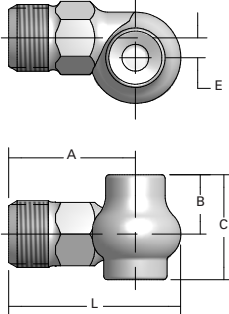
Nozzle	Nozzle Type	Conn. Size/Type (in.)	L (mm)	A (mm)	B (mm)	C (mm)	E (mm)	Net Weight (kg)
	CRC	1-1/4 female	86.5	54.0	53.2	77.8	10.3	1.02
		2 female	123.0	81.0	77.8	118.3	18.3	2.27
		3 female	176.2	112.7	150.8	213.5	28.6	8.62
		4 female	228.6	141.3	231.8	311.2	39.7	18.14
	D	1/2 male	58.7	44.5	18.3	33.3	6.4	0.14
		3/4 male	69.1	50.8	23.8	42.1	7.9	0.21
	AP AP-W	1/4 female	36.5	25.4	22.0	29.4	4.0	0.01
		3/8 female	37.3	27.8	22.0	29.4	4.0	0.01
	LAP LAP-W	3/8 female	48.4	32.5	30.0	40.5	4.9	0.02
		1/2 female	51.6	35.7	30.0	40.5	4.9	0.02

Based on the largest/heaviest version of each type.

DIMENSIONS AND WEIGHTS

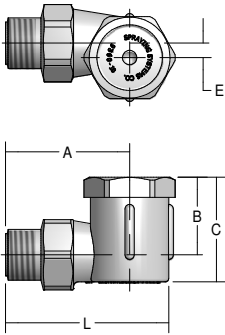
Nozzle	Nozzle Type	Conn. Size/Type (in.)	L (mm)	A (mm)	B (mm)	C (mm)	E (mm)	Net Weight (kg)
	LBP LBP-W	53.2 male	39.7	31.4	40.5	4.9	0.02	0.6

Based on the largest/heaviest version of each type.

DIMENSIONS AND WEIGHTS

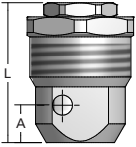
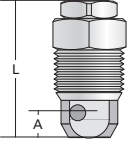
Nozzle	Nozzle Type	Conn. Size/Type (in.)	L (mm)	Hex. (in.)	A (mm)	Net Weight (kg)
	BD	3/8 male	31.8	11/16	6.7	0.03
		1/2 male	37.3	7/8	8.0	0.06
		3/4 male	44.5	1-1/16	9.5	0.11
		1-1/2 male	66.7	2	8.0	0.60
	BDM	3/8 male	32.5	11/16	6.7	0.01

Based on the largest/heaviest version of each type.

PLACING YOUR ORDER

Call your local spray expert for application assistance or to place an order.

PERFORMANCE DATA
STANDARD ANGLE SPRAY

Conn. Size (in.)	Nozzle Type	Spray Angle at 0.7 bar					Capacity Size	Orifice Dia. Nom. (mm)	Max. Free Passage Dia. (mm)	Flow Rate Capacity (liters per minute)					
		BSJ	50°	60°	90°	120°				180°	0.4 bar	0.7 bar	1.5 bar	3 bar	7 bar
1/4	•	•	•	•	•	•	07	2.4	2.4	2.0	2.7	3.9	5.5	8.4	16.0
	•	•	•	•	•	•	13	3.2	3.2	3.7	5.0	7.3	10.3	15.7	30
	•	•	•	•	•	•	20	4.0	3.2	5.8	7.6	11.2	15.8	24	46
3/8	•	•	•	•	•	•	30	4.8	3.2	8.6	11.4	16.8	24	36	68
	•	•	•	•	•	•	40	5.6	3.2	11.5	15.3	22	32	48	91
	•	•	•	•	•	•	53	6.4	3.2	15.3	20	30	42	64	121
1/2	•	•	•	•	•	•	82	7.9	3.2	24	31	46	65	99	187
	•	•	•	•	•	•	120	9.5	4.8	35	46	67	95	145	274
	•	•	•	•	•	•	164	11.1	4.8	47	63	92	129	198	374
3/4	•	•	•	•	•	•	210	12.7	4.8	61	80	117	166	253	479
1	•	•	•	•	•	•	340	15.9	6.4	98	130	190	268	410	775
	•	•	•	•	•	•	470	19.1	6.4	136	179	262	371	567	1071
1-1/2	•	•	•	•	•	•	640	22.2	7.9	185	244	357	505	772	1459
	•	•	•	•	•	•	820	25.4	7.9	236	313	458	647	989	1869
	•	•	•	•	•	•	960	28.6	7.9	277	366	536	758	1158	2188
2	•	•	•	•	•	•	1400	34.9	11.1	404	534	782	1105	1689	3191
	•	•	•	•	•	•	1780	38.1	11.1	513	679	994	1406	2147	4057

Maximum Free Passage Diameter is the maximum diameter as listed of foreign matter that can pass through the nozzle without clogging. For all 1/4" and 3/8" connections, optimum spray angle is achieved at 40 psi (2.8 bar).

*Maximum operating pressure depends on material, size and application. Contact your local sales engineer for specific recommendations.

Highlighted column shows the rated pressure.

DIMENSIONS AND WEIGHTS

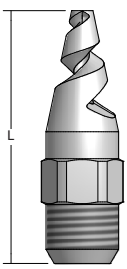
Nozzle	Nozzle Type	Conn. Size/Type (in.)	L (mm)	Hex. / flats (in.)	Net Weight (kg)
	BSJ	1/4 male	49.2	9/16	0.03
		3/8 male	47.6	11/16	0.05
		1/2 male	63.5	7/8	0.09
		3/4 male	69.9	1-1/16	0.14
		1 male	92.1	1-3/8	0.31
		1-1/2 male	111.1	2	0.77
		2 male	174.6	2-1/2	1.36

Based on the largest/heaviest version of each type.

PLACING YOUR ORDER

Call your local spray expert for application assistance or to place an order.

