

SHOWER NOZZLES

TABLE OF CONTENTS

	PAGE
ShowerJet One-piece, High-pressure	C3
ShowerJet Disc-type	C4
Lock Rings	C5
NeedleJet Nozzles	C6
DiscJet® Nozzles	C8
Self-Cleaning Nozzles	C9

QUICK REFERENCE GUIDE

Model Standard (Metric)	Connection/ Type	Connection/ Thread Size in. (mm)	Flow Rate Range gpm (lpm)	Max. Operating Pressure psi (bar)	Spray Angle	Materials
ShowerJet One-piece, High-pressure Nozzles						
73196 (M73196)	M	1-3/16"-18 (M30 x 1.5)	.02 to 1.12 gpm (.08 to 4.24 lpm)	800 psi (55 bar)	0° at 40 psi (3 bar)	316 stainless steel body with synthetic ruby orifice
73327 (M73327)	M	1-1/4"-18 (M32 x 1.5)				
37337 (M37337)	M	1-3/16"-18 (M30 x 1.5)				
38553 (M38553)	M	1-1/4"-18 (M32 x 1.5)				
39468	M	1-3/8"-12				316 stainless steel body and orifice
ShowerJet Disc-type Nozzles						
27149	Disc type	NA	.03 to 55 gpm (.11 to 208 lpm)	800 psi (55 bar)	0° to 75° at 60 psi (4 bar)	316L stainless steel body and orifice
39350	Disc type	NA	.02 to 1.12 gpm (.08 to 4.24 lpm)		0° at 40 psi (3 bar)	316 stainless steel body with ceramic orifice
48546	Disc type	NA				316L stainless steel body with synthetic ruby orifice
50790	Disc type	NA				316L stainless steel body and orifice
39485	Disc type	NA				
ShowerJet Lock Rings						
27044	M	See page C5	NA	NA	NA	316 stainless steel
31250	M	See page C5				
28376	M	See page C5				
NeedleJet Nozzles – Tapered Front						
48460	M	9/16"-24	.032 to 11.0 gpm (.12 to 41.6 lpm)	1000 psi (70 bar)	0° at 40 psi (3 bar)	316 stainless steel body with synthetic ruby orifice
19124	M	9/16"-24				316 stainless steel body and orifice
P36503	M	1/4" BSPP				
NeedleJet Nozzles – Longer Length						
56740	M	1/8" BSPP	.032 to 11.0 gpm (.12 to 41.6 lpm)	1000 psi (70 bar)	0° at 40 psi (3 bar)	316 stainless steel body with synthetic ruby orifice
48277	M	1/8"				316 stainless steel
21280	M	9/16"-24 NEF				316 stainless steel nozzle and extension tube
39458	M	9/16"-24 NEF				316 stainless steel nozzle and extension tube with ceramic orifice
NeedleJet Nozzles – Compact						
22812	M	1/8"	.032 to 11.0 gpm (.12 to 41.6 lpm)	1000 psi (70 bar)	0° at 40 psi (3 bar)	316 stainless steel body and orifice
20094	M	1/4"-28 UNF				
DiscJet® Nozzles						
DK	Disc type	Threadless	.025 to 16.7 gpm (.09 to 63.22 lpm)	150 psi (10 bar)	0° to 90° at 40 psi (3 bar)	303 stainless steel or 316 stainless steel
DJ	M	5/8"-18			25° to 110° at 40 psi (3 bar)	
48284	Disc type	Threadless			316 stainless steel	
25834	Disc type	Threadless				
Self-cleaning Nozzles						
20210	M	1-1/8"-20	.008 to 12.6 gpm (.03 to 47.7 lpm)	250 psi (17 bar)	0° to 130° at 40 psi (3 bar)	316 stainless steel deflector, body, piston, nut and spring
20235	M	3/4"-20				



OVERVIEW: SHOWERJET ONE-PIECE, HIGH-PRESSURE NOZZLES

Ideal for: easy replacement of ShowerJet and most other manufacturer showers

- Consolidated nozzle design eliminates the separate nut and gasket. All-in-one design saves time during installation and removal
- Faster and easier installation into the header using a 3/8" (9.5 mm) hex wrench
- Available in a variety of body lengths
- Powerful solid stream spray from .02 to 1.12 gpm (.08 to 4.24 lpm)
- Operating pressures up to 800 psi (55 bar)

ONE-PIECE, HIGH-PRESSURE NOZZLE OPTIONS



73196 & 73327

Solid stream spray pattern
 Ruby orifice for longer wear life
 Integral lock rings



37337, 38553 & 39468

Solid stream spray pattern
 Stainless steel orifices

QUICK REFERENCE GUIDE

Model Standard (Metric)	Connection Thread Size in. (mm)	Flow Rate Range gpm (lpm)	Materials
73196 (M73196)	1-3/16"-18 (M30 x 1.5)	.02 to 1.12 gpm (.08 to 4.24 lpm)	316 stainless steel body with synthetic ruby orifice
73327 (M73327)	1-1/4"-18 (M32 x 1.5)		
37337 (M37337)	1-3/16"-18 (M30 x 1.5)		316 stainless steel body and orifice
38553 (M38553)	1-1/4"-18 (M32 x 1.5)		
39468	1-3/8"-12		

FOR DETAILED NOZZLE PERFORMANCE DATA, SEE spray.com/papercatalog/performance



OVERVIEW: SHOWERJET DISC-TYPE NOZZLES**Ideal for: use with automatic brush showers**

- Disc-type nozzles fit inside the shower; the internal brushes easily sweep debris away
- Lock ring holds the nozzles in place
- Available in flat and solid stream spray patterns
- Solid stream versions: Choose from ceramic, stainless steel or synthetic ruby orifice material for longer wear life
- Notches on flat spray version allow removal of installed nozzles from the base with a flathead screwdriver – a Spraying Systems Co. exclusive
- All ShowerJet nozzles are installed with a standard gasket which is included, CP28624-001
- 27149 provides uniform spray distribution from .03 to 55 gpm (.11 to 208 lpm)
- 39350, 48546, 50790 & 39485 powerful solid stream spray from .02 to 1.12 gpm (.08 to 4.24 lpm)
- Operating pressures up to 800 psi (55 bar)

DISC-TYPE NOZZLE OPTIONS**27149**

- Notched flats for easy removal
- Flat spray pattern
- 316L stainless steel orifice

**39350**

- Dome shape
- Solid stream spray pattern
- Ceramic orifice

**48546**

- Dome shape
- Solid stream spray pattern
- 316L stainless steel body; synthetic ruby orifice

**50790 & 39485**

- Low profile design
- Solid stream spray pattern
- 50790 has a 316L stainless steel body and synthetic ruby orifice; 39485 has a 316L stainless steel body and orifice
- Order 50790 for Stamm showers; 50790-1 for Spraying Systems Co. showers



FOR DETAILED NOZZLE PERFORMANCE DATA, SEE
spray.com/papercatalog/performance

LOCK RING OPTIONS

27044 and 31250

- 27044 for use with Spraying Systems Co. shower bases
- 31250 for use with shower bases from other manufacturers



Model	Thread Size	For Shower Headers Supplied By
CP27044-001-316SS	1-3/16"-18 UNEF	SSCo. Standard/NASH-CVN
CP27044-002-316SS	1-3/16"-18 UNEF	SSCo. 75° ShowerJet
CP31250-001-316SS	M32 x 1.5	Valmet
CP31250-002-316SS	M30 x 1	Stamm
CP31250-003-316SS	1-1/4"-18 UNEF	Lechler
CP31250-005-316SS	M30 x 1.5	Voith

28376, 29676 and 29677

- Convert existing showers to alternate nozzles as needs change
- Can be used with dome strainer 28900 when on a brush header
- Thread sizes for Spraying System Co and competitive showers

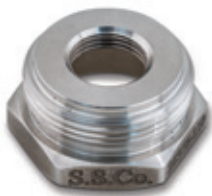

Part Number	"A" Thread	"B" Thread
28376-1/4-316SS	1/4"	1-3/16"-18
28376-3/8-316SS	3/8"	1-3/16"-18
28376-110-316SS	9/16"-24	1-3/16"-18
29676-1/4-316SS	1/4"	1-1/4"-18
29676-3/8 x 1-1/4-316SS	3/8"	1-1/4"-18
29676-1/4 x M30 x 1-316SS	1/4"	M30 x 1.0
29676-103-316SS	9/16"-24	M30 x 1.0
29676-1/4 x M30 x 1.5-316SS	1/4"	M30 x 1.5
29676-1/4 x M32 x 1.5-316SS	1/4"	M32 x 1.5
29676-1/8 x M32 x 1.5-316SS	1/8"	M32 x 1.5
29676-202-316SS	9/16"-24	M32 x 1.5
29677-P x 1-1/8-316SS	PLUG	1-1/8"-20
29677-1/4 x 1-3/4-316SS	1/4"	1-3/4"-8

FOR DETAILED NOZZLE PERFORMANCE DATA, SEE spray.com/papercatalog/performance



OVERVIEW: NEEDLEJET NOZZLES



Ideal for: effectively cleaning and washing of felts, fabric/wire and suction rolls





- High-performance NeedleJet nozzles provide powerful solid stream sprays to effectively clean and wash felts, fabric/wire and suction rolls
- Precision-machined to provide tight flow control
- For use with a wide range of showers, including oscillating
- Versions with tubes or extensions in the back end that protrude higher into the shower. This enables better quality water to be drawn into the nozzle and minimizes turbulence
- Powerful solid stream spray from .032 to 11.0 gpm (.12 to 41.6 lpm)
- Operating pressures up to 1000 psi (70 bar)

NEEDLEJET NOZZLE OPTIONS

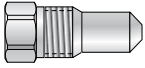

STYLES

Model	Model Type	Description	Connection Thread Size	Hex in. (mm)	Materials
	48460	Tapered front	9/16"-24 NEF	11/16 (17.5)	316 stainless steel body with synthetic ruby orifice
	19124	Tapered front	9/16"-24 NEF	11/16 (17.5)	316 stainless steel
	P36503	Tapered front	1/4" BSPP	11/16 (17.5)	316 stainless steel

Model	Model Type	Description	Connection Thread Size	Hex in. (mm)	Materials
	56740	Longer length design	1/8" BSPP	7/16 (11.1)	316 stainless steel body with synthetic ruby orifice
	48277	Longer length design with extended inlet	1/8"	7/16 (11.1)	316 stainless steel
	21280	Longer length design with extended inlet	9/16"-24 NEF	11/16 (17.5)	316 stainless steel – nozzle and extension tube
	39458	Longer length design with extended inlet	9/16"-24 NEF	11/16 (17.5)	316 stainless steel nozzle and extension tube; ceramic orifice
	22812	Compact design; front of nozzle is flat, not rounded	1/8"	7/16 (11.1)	316 stainless steel
	20094	Compact design	1/4"-28 UNF	5/16 (7.9)	316 stainless steel

FOR DETAILED NOZZLE PERFORMANCE DATA, SEE spray.com/papercatalog/performance

OVERVIEW: DISCJET NOZZLES

Ideal for: fitting into tight spaces

- DiscJet nozzles are ideal for when space is tight; nozzle flush mounts in shower
- Compact design provides uniform coverage
- Provides effective cleaning with minimal water use
- Entrance to orifice designed to prevent clogging
- Offset 5° from shower axis to avoid interference with adjacent sprays
- For use with 46143 retainer cap and 46144 gasket
- Powerful solid stream spray from .025 to 16.7 gpm (.09 to 63.22 lpm)
- Operating pressures up to 150 psi (10 bar)

DISCJET NOZZLE OPTIONS

**DK versions**

Flat spray pattern
Threadless connection
.125 thickness

**DJ versions**

Flat spray pattern
5/8"-18 threaded connection
.125 thickness

**48284**

Solid stream
Threadless connection
.125 thickness

**25834**

Solid stream
Threadless connection
.095 thickness

FOR DETAILED NOZZLE PERFORMANCE DATA, SEE
spray.com/papercatalog/performance

OVERVIEW: SELF-CLEANING NOZZLES

Ideal for: use in environments with suspended solids and showers with high solids content in the water

- For use with white water on save-all and knock-off showers
- Features a piston-type design. When line pressure is low, the nozzle's piston retracts to purge debris from the nozzle orifice
- Available with low or high actuator pressures
- Compact design fits easily inside paper machines
- Fast, easy installation and alignment
- Uniform spray distribution from .008 to 12.6 gpm (.03 to 47.7 lpm)
- Operating pressures up to 250 psi (17 bar)

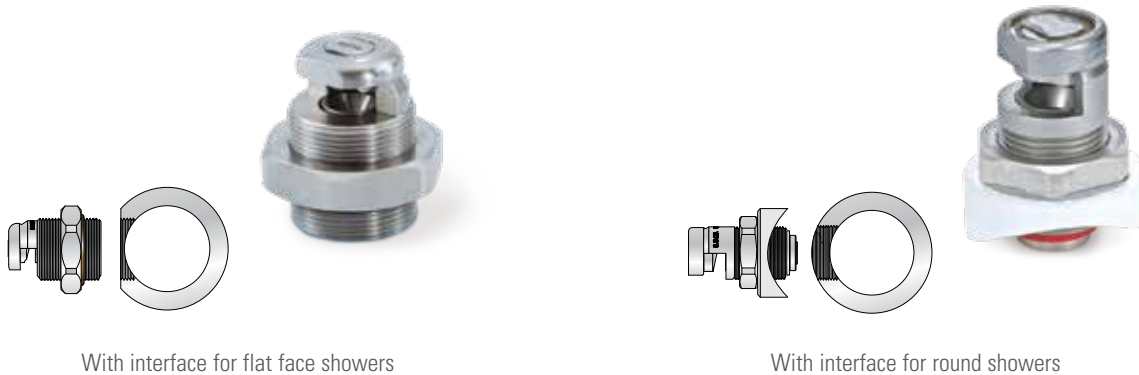

SELF-CLEANING NOZZLE OPTIONS





With interface for flat face showers

With interface for round showers

STYLES

Model	Model Type	Spray Pattern	Description	Connection Thread Size	Hex in. (mm)	Materials
	20210	Flat and solid stream	Hex nut with O-ring for interface with flat face on shower headers	1-1/8"-20 UN	1-1/2 (38.1)	316 stainless steel body with 302 stainless steel spring, Buna-N O-ring and Fairprene® diaphragm
	20235	Flat	Hex nut with polypropylene saddle gasket for interface with round shower headers	3/4"-20 UNEF	1 (25.4)	316 stainless steel body with 302 stainless steel spring, silicone rubber diaphragm and polypropylene saddle gasket
	26225	Flat and solid stream	Hex nut with O-ring interface with flat face on shower	3/4"-20 UNEF	1 (25.4)	316 stainless steel body and spring, Viton® O-ring and silicone rubber diaphragm

STYLES

Model	Model Type	Spray Pattern	Description	Connection Thread Size	Hex in. (mm)	Materials
	26411	Flat	Solid stream pattern: hex nut with O-ring	3/4" BSPP	1-1/2 (38.1)	316 stainless steel body and spring, Viton® O-ring and natural rubber diaphragm
	36090	Flat and solid stream	Hex nut with O-ring interface with flat face on shower	M28 x 1.5	1-1/2 (38.1)	316 stainless steel body with 302 stainless steel spring, Buna-N O-ring and Fairprene® diaphragm
	38332	Flat	Self-sealing design for interface with any shower header	3/4"	1-1/16 (27)	316 stainless steel body and spring, silicone rubber diaphragm
	38490	Double solid stream*	Hex nut with O-ring interface with flat face on shower	1-1/8"-20 UN	1-1/2 (38.1)	316 stainless steel body and spring, Buna-N O-ring and Fairprene diaphragm
	49905	Double flat spray*	Hex nut with O-ring interface with flat face on shower	1-1/8"-20 UN	1-1/2 (38.1)	316 stainless steel body with 302 stainless steel spring, Buna-N O-ring and Fairprene diaphragm
	49905-1			M28 x 1.5		
	72370	Flat	Self-sealing design for interface with any shower header that has 1/2" NPT ports	1/2" NPT (male)	.812 (20.9) flats	316 stainless steel body with 302 stainless steel spring, silicone rubber diaphragm

* Capacity size is for the entire nozzle assembly.

FOR DETAILED NOZZLE PERFORMANCE DATA, SEE
spray.com/papercatalog/performance