



PERFORMANCE MAY  
BE AFFECTED IF GAP  
IS ADJUSTED

CAUTION  
SURFACES  
MAY BE HOT



**Spraying Systems Co.®**  
Experts in aSprayTechnology

# WINDJET®

Air Control & Blow-off Nozzles  
and Accessories

CATALOG 224h



# TABLE OF CONTENTS

<b>BLOWER AIR PRODUCTS</b>	<b>PAGE</b>
Detailed Table of Contents	3
<b>COMPRESSED AIR PRODUCTS</b>	
Detailed Table of Contents	11

## HOW TO OPTIMIZE DRYING AND BLOW-OFF OPERATIONS AND DRAMATICALLY REDUCE OPERATING COSTS

You may not give much thought to your drying and blow-off operations if you aren't experiencing problems. But, new technology makes it possible to dry parts more thoroughly and quickly, improve precision in blow-off and achieve dramatic reductions in compressed air use. In fact, you may be able to save tens of thousands or even hundreds of thousands of dollars annually by using less compressed air or eliminating it completely. In addition to improving operating efficiency and lowering costs, adapting new technology can help reduce noise and improve worker safety.

Many plants use open or drilled pipe for drying and blow-off. These systems are inexpensive to make but very expensive to operate, are noisy and can be dangerous. There are many alternatives to consider.

### WindJet Air Knife packages that use blower air:

- No compressed air required
- Low operating noise

### WindJet air nozzles that use compressed air:

- Low flow air knives that use 89% to 92% less air than open pipe
- Air amplifiers that use 75% to 90% less air than open pipe
- Air nozzles that use compressed air that use 25% to 35% less air than open pipe
- All these nozzles provide perceived noise reductions ranging from 28% to 60% less than open pipe





# AIRKNIVES & BLOWER

PAGE

WindJet® AirKnives	4
WindJet® YLBW Nozzle for Blower	5
Air Cannon	6
WindJet® AirKnife Accessories	7
WindJet® AirKnife Blower Packages	8-9

Advantages of WindJet AirKnife with Blower:

- No compressed air required
- Low operating noise

### WINDJET AIRKNIVES

To ensure air stream integrity, WindJet air knives feature a unique leading edge design that directs the airflow out of the knife in a straight stream. This design uses the Coanda effect and air entrainment to economically produce a uniform and constant air stream. The Coanda effect induces the supplied air to attach itself to the surface of the air knife and helps maintain the integrity of the air stream further downstream. This effect also creates a condition conducive to entraining ambient air to increase the total volume of air. The result of this leading edge design is a uniform, high volume, constant air stream along the entire length of the knife. The spotting and blotching problems associated with many air knives are eliminated. Another advantage of the leading edge design is that it provides a visual guide for positioning the air stream, pointing out the direction of the flow. This allows easy positioning of the knife to ensure maximum target coverage. Extended edge design improves air entrainment and ensures the integrity of the air stream.



Extended edge design improves air entrainment and ensures the integrity of the air stream.

### FEATURES AND BENEFITS

- Superior performance – straight, controlled air stream
- Air slot sizes of .040" and .060" (1 and 1.5 mm)
- Easy-set-up
- Leak-proof end cap gaskets to prevent leakage on aluminum air knives
- Corrosion-resistant finish
- Long wear life
- 3" flanged air inlet
- Also available in 316 stainless steel

### TECHNICAL DATA

Type	Standard Length AirKnife [Zoll – mm]	Length Air Slot [Zoll / mm]	Material
50750-06-040	6" up to 168" (152 - 4267)	0,040" / 1,0	Aluminum
50750-06-060		0,060" / 1,5	
50700-06-040	6" – 152	0,040" / 1,0	Stainless Steel
50700-12-040	12" – 304	0,040" / 1,0	
50700-18-040	18" – 457	0,040" / 1,0	
50700-24-040	24" – 609	0,040" / 1,0	
50700-30-040	30" – 762	0,040" / 1,0	
50700-36-040	36" – 914	0,040" / 1,0	

### DIMENSIONS

Type	A [mm]	B [mm]	C [Zoll]	D [mm]	E* [mm]	E* [Zoll]	F [mm]
50700 or 50750	99	5/16-18 UNC	3"	51	152	6"	123
					304	12"	
					457	18"	
					609	24"	
					762	30"	
914	36"						

\*= Available in 2 types with air slots of 1.0 mm (0.040") or 1.5 mm (0.060").

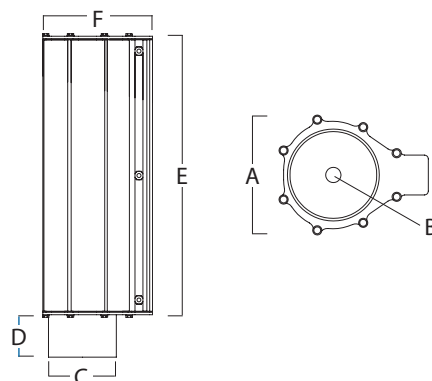
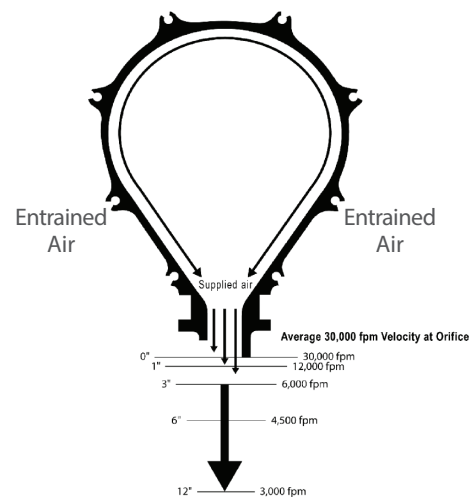

WindJet YLBW - Air Control Nozzle for Blowers

Palm-sized body taking advantages of blower air features and versatile flat air pattern



FEATURES AND BENEFITS

- Designed to enhance air stabilizing flow and to convert low-pressure air into a high-velocity and high impact air stream
- Blowing 53mm width flat air despite the compact body
- Save on energy cost by switching from compressor type
- Recessed orifices offer air escape should the nozzles accidentally be placed against a flat surface
- Spray headers allow to place multiple nozzles in line for sweeping wide areas and adjustable hoses allow to spray uneven surface or complex-shaped target

QUICK REFERENCE GUIDE

	YBLW-B1/2-SS
Max. Operating Pressure	1 bar
Max. Operating Temperature	200 °C
Connection Size	R1/2 (1/2 NPT on request)
Air Capacity	350 l/min under 0.2 bar (20 °C)
Material	Equivalent to SUS304
Weight	63 g

DIMENSIONS

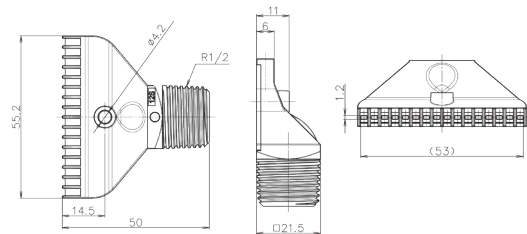

IMPACT

Pressure: 0.2 bar

Size of pressure receiving plate: 10 x 60 mm

Spray Distance: red = 20 mm / blue = 50 mm / green = 100 mm / orange = 200 mm

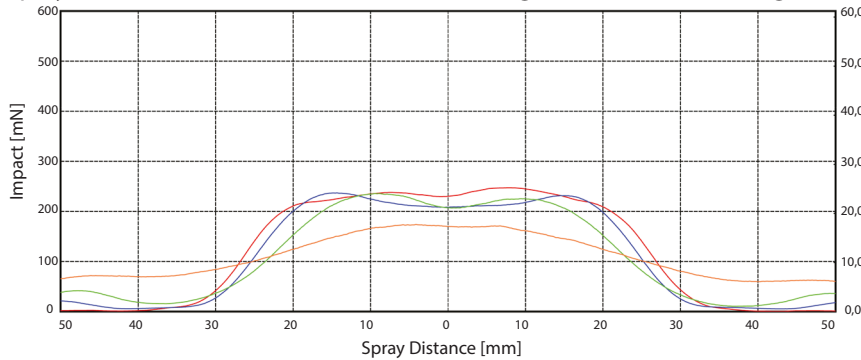

PERFORMANCE CURVE\*

\*Data at 20 °C and 101.3 kPa

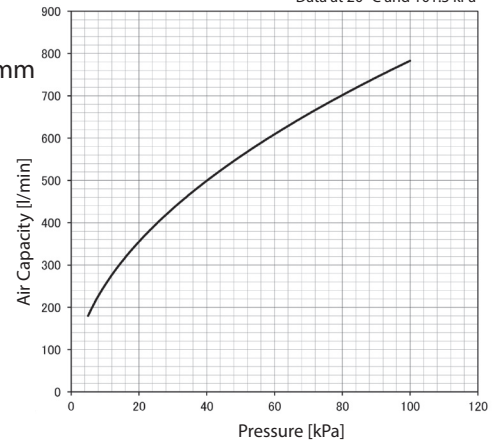

AIR VELOCITY CURVE\*

Spray Direction: Downwards

Spray Distance: light blue = 30 mm / orange = 50 mm / grey = 100 mm / yellow = 200 mm  
red = 300 mm / green = 500 mm / dark blue = 1000 mm

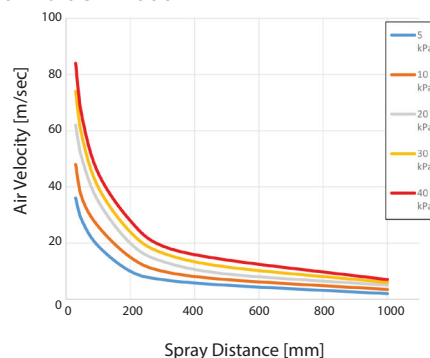
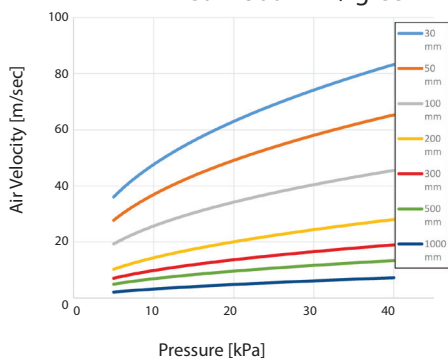

\* Data (actual measured value) collected by spray distance

AIR CANNON

- Used in conjunction with air knife packages for complete drying by providing a high velocity air stream into holes and indentations in irregularly shaped parts
- Built-in mount spacer simplifies positioning in a mount bracket
- Anodized aluminum construction for corrosion-resistance and long wear life. Also available in 316 stainless steel.
- Three orifice sizes: 0.5", 0.75" and 1" (13, 19 and 25 mm)
- Weight: 740 g



TECHNICAL DATA

Type	Size Orifices [mm]	Outlet ODs ["]
55155-500	13	0,50 res. 1/2
55155-750	19	0,75 res. 3/4
55155-1000	25	1,00 res. 1

DIMENSIONS

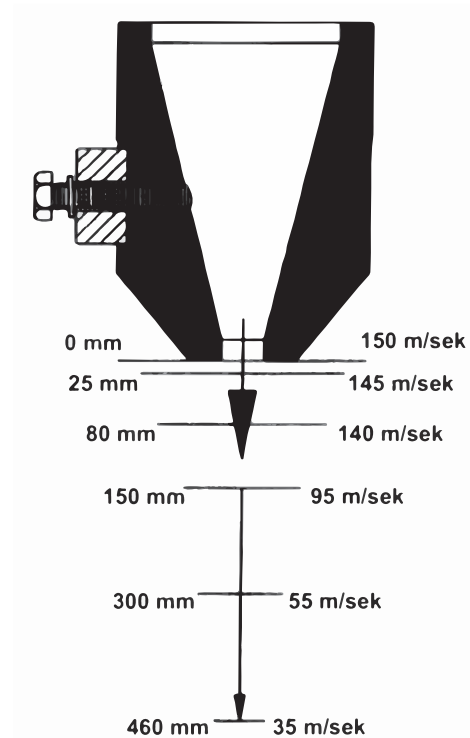
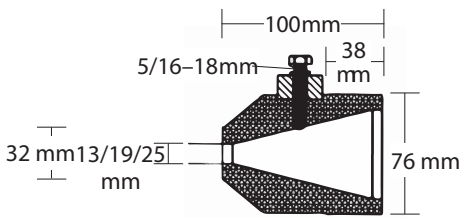

ORDERING INFORMATION

Nozzle Type	-	Material	Example
			55155-500 - AL

## ENSURE EFFICIENT AIR DELIVERY FROM THE BLOWER TO THE KNIVES

All necessary accessories for mounting and implementing the product into your applications are included in the air knife package. Accessories vary by package. All items are rated for a minimum of 107 °C.

<p>Elbows</p> 	<p>To help reduce pressure losses in the system, we offer both 45° and 90° rigid elbows in 3" and 6" (76 and 152 mm) diameters. Request data sheet 50779.</p>
<p>Mounting Brackets</p> 	<p>These 100% stainless steel adjustable brackets are used for conveniently mounting air knives. Two specialized mounting plates connect to each end cap on the air knife. Request data sheets 50040 and 55158 for dimensions.</p>
<p>Flexible Tubing</p> 	<p>High-temperature, steel-reinforced flexible tubing available in 3" and 6" (76 and 152 mm) diameters and comes in lengths of 10' (3 m). High-torque, worm-gear clamps are available to attach the flexible tubing.</p>
<p>Couplings</p> 	<p>Unique, easy to use 3" and 6" (76.2 and 152.4 mm) couplings – stainless steel outside, high temperature silicon rubber inside. The couplings compress for use between any rigid connections to prevent air leakage and to add support for the connections. A single built-in clamp is tightened by hand; no special tools are necessary.</p>
<p>Manifolds</p> 	<p>Constructed from high-strength, high-temperature thermoplastic, manifolds allow a single air outlet on the blower to be divided for multiple knives in various ways.</p> <ul style="list-style-type: none"> <li>• Y-divider: Allows for single inlet to be divided into two outlets. Available in both 3" and 6" (76 and 152 mm) inlet OD, with 3" (76 mm) outlet OD.</li> <li>• 3-port: Allows for single inlet to be divided into three outlets. Available in both 3" and 6" (76 and 152 mm) inlet OD, with 3" (76 mm) outlet OD. Designed with mounting holes for support.</li> <li>• 4-port* (shown): Allows for single inlet to be divided into four outlets. Available in both 3" and 6" (76 and 152 mm) inlet OD, with 3" (76 mm) outlet OD. Designed with mounting holes for support.</li> </ul> <p>*Not available in stainless steel.</p> <p>Request data sheets 50773 and 50774 for additional dimensions of manifolds. Stainless steel manifolds also available.</p>
<p>Noise Reduction Options</p> 	<p>Muffler: Reduces noise by 5 to 8 dBA and removes high frequency sound associated with all blowers. Sound Enclosure (shown): Insulating hoods reduce noise by 10 dBA. Metal construction for easy washdown. Request data sheet 50218.</p>



Using a system powered by blower air can reduce operating costs by 95% or more. In addition to reducing costs, WindJet air knife/blower packages offer:

- Clean, heated air
- Low operating noise – no sound enclosures are typically required
- Easy installation and operation

The following applications are good candidates for air knife/blower systems:

- Velocity rather than impact is required
- The oil in compressed air is causing quality problems
- Large application areas – more than 2' (61 cm)
- Heated air is needed
- Air knives can be placed close to the target surface – 4" (10 cm) or less

REGENERATIVE BLOWERS

Unlike other blower types, regenerative blowers are rugged, reliable and require infrequent, minimal maintenance. These blowers use a dynamic operating principle that recycles a certain amount of air and provide performance comparable to many multi-stage or positive displacement blowers.

In a regenerative blower, the compression space consists of a hollow circular ring between the tips of the impeller blades and the walls of the housing. In operation, the rotating impeller draws air from the inlet port into the compression space and moves it radially outward to the curved housing by centrifugal force. The action is called “regenerative” because a certain amount of air slips past each impeller blade during rotation and returns to the base of a succeeding blade for re-acceleration.

REGENERATIVE BLOWER ASSEMBLIES

- 3 / 7,5 / 9,2 / 11 and 15 kW. Assemblies include pressure relief valve, pressure gauge, air inlet filter, filter monitoring gauge, fittings, mounting adapter for flexible or rigid tubing
- Low maintenance, direct drive operation
- Fan cooling dissipates heat around the bearings to extend wear life
- Continuous, non-pulsating, oil-free air flow
- Low noise
- Rugged cast aluminum construction
- Lightweight
- Tropicalized for corrosion protection
- No heating element; air is warmed by heat generated during operation
- TEFC motors; CE and cURus certified
- Mountable in any position
- Three-phase, dual frequency and multi-voltage motor versions
- Filter monitoring gauge protects blowers from overheating due to clogged filter elements

THE REGENERATIVE PRINCIPLE

In a regenerative blower, the compression space consists of a hollow circular ring between the tips of the impeller blades and the walls of the housing. In operation, the rotating impeller draws air from the inlet port into the compression space and moves it radially outward to the curved housing by centrifugal force. The action is called “regenerative” because a certain amount of air slips past each impeller blade during rotation and returns to the base of a succeeding blade for re-acceleration.

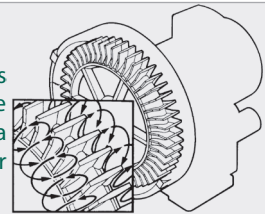

QUICK REFERENCE GUIDE

Type	Weight [kg]	Connection [mm]
3	44.5	76.2 (3")
7,5	71.5	76.2 (3")
9,2	106.0	101.6 (4")
11	117.0	130.0
15	133.0	130.0

SPECIFICATIONS

Type	Hp [kw]	Max. Capacity [m³h]	Max. Pressure [kPa]	Voltage [Volt]	Amps [A]	Blower Sound Levels [dBa]
3	3.0	409	17.5	230/400	11.2 / 6.5	71.5
7,5	7.5	563	30.0	400/690	15.1 / 8.7	75.8
9,2	9.2	1007	21.0	400/690	18.2 / 10.5	80.1
11	11.0	1325	19.0	400/690	23.0 / 13.3	81.0
15	15.0	1539	22.5	400/690	27.3 / 15.8	86.1



DIMENSIONS

Type	A [mm]	B [mm]	C [mm]	D [mm]	E [mm]	F [mm]	G [mm]	H [mm]
3	422	300	634	959	4x13	374	404	637
7,5	450	300	662	987	4x13	374	404	785
9,2	548	500	802	1242	4x13	448	478	828
11	610	500	850	1355	4x13	478	508	892
15	623	500	850	1355	4x13	478	508	892

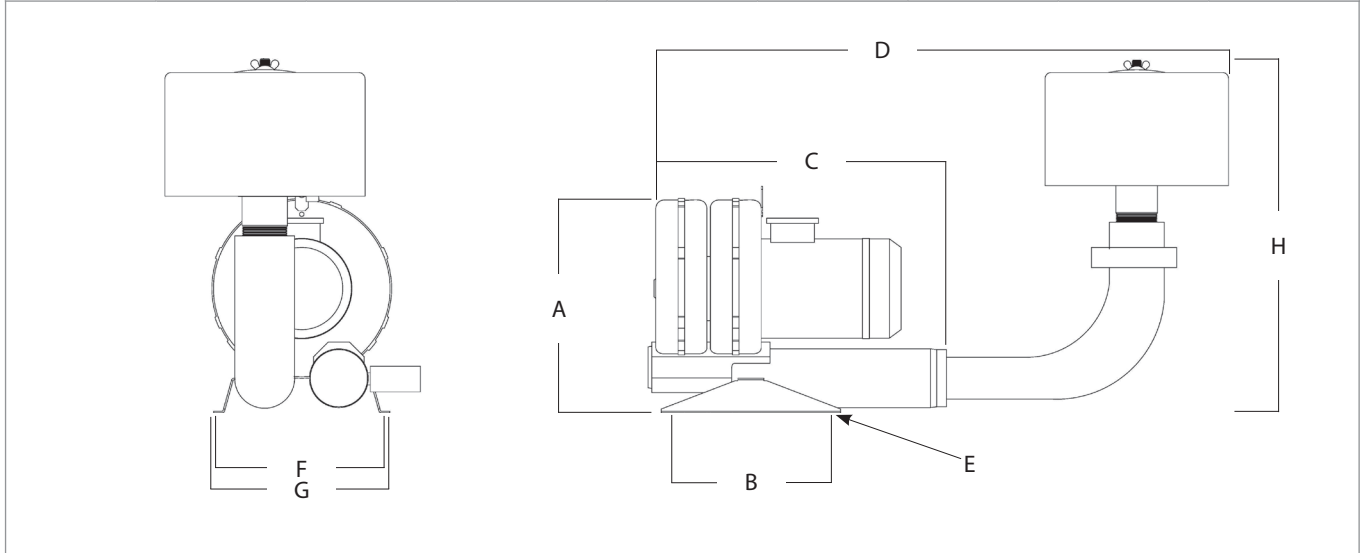

AIR VELOCITY

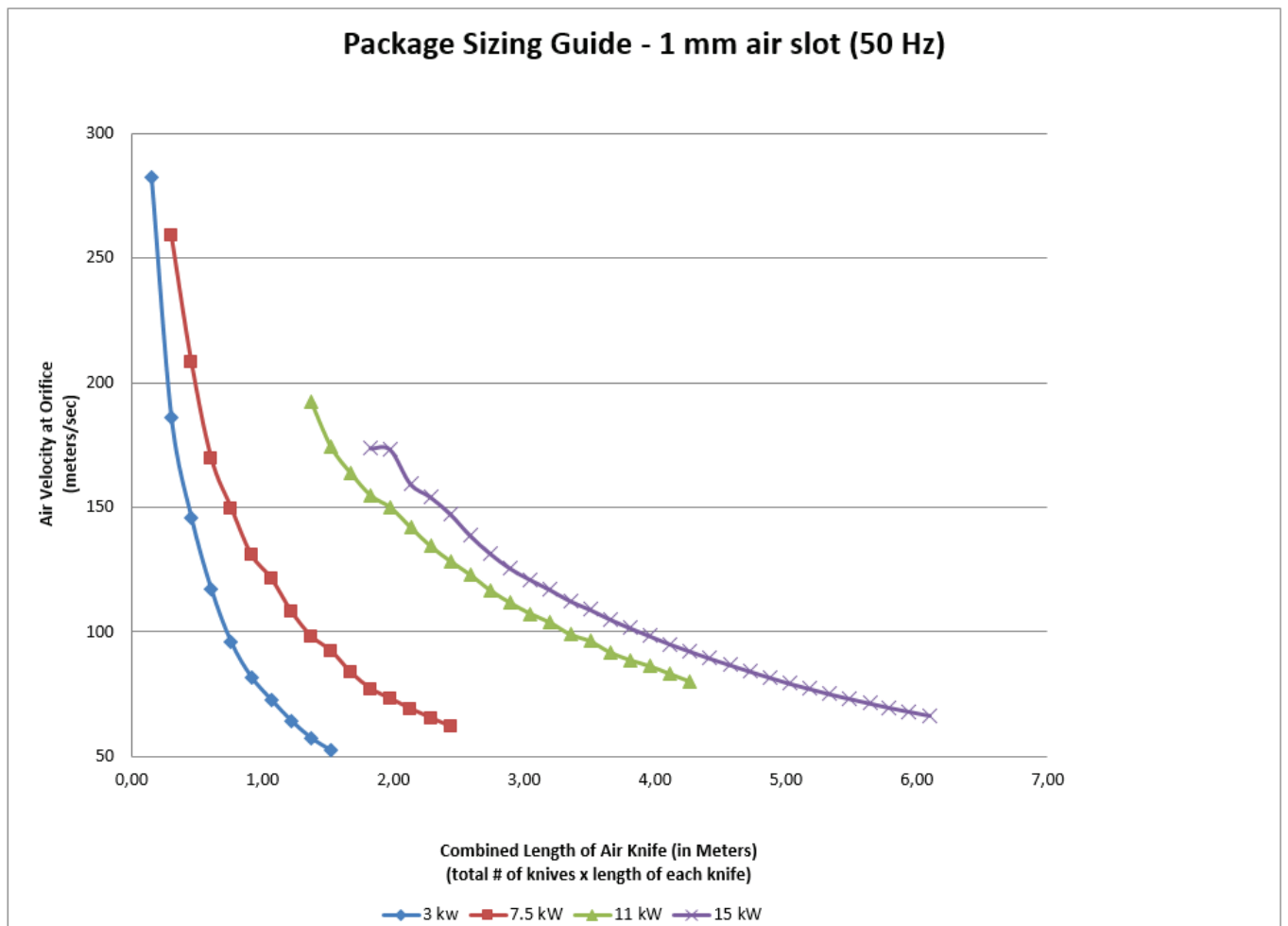





## COMPRESSED AIR PRODUCTS

	PAGE
Overview Air Consumption	12+13
WindJet® Air Nozzles	14+15
UniJet® and FloodJet® Air Nozzles	16+17
WindJet® Air Nozzles	18+19
Blowing Rings	20+21
WindJet® Low Flow Air Knives	22+23
WindJet® Variable Air Amplifiers	24+25
Air Accessories	26+27
WindJet® Customized Manifolds	28+29
Optimization Tips	30+31

WINDJET AIR NOZZLES: OVERVIEW

Air nozzles convert a low-pressure volume of compressed air into a targeted high-velocity concentrated air stream, flat fan or curtain of high-impact air. Ideal for use in many applications, WindJet air nozzles come in a variety of types, capacities, sizes and materials.

WindJet nozzles are widely used for moving materials and cleaning, drying and cooling parts. The high impact provided by these nozzles ensures effective drying and blow-off even for round or oddly shaped products.

The benefits WindJet air nozzles provide:

- A significant reduction in compressed air consumption compared to open pipes.
- Up to 60% reduction in perceived noise level, depending on the initial air pressure. At 7 bar, for example, an open pipe would produce a noise level of 98 dBa while an air nozzle would produce 85 dBa, a reduction of 13 dBa and a perceived noise reduction of 60%
- Improved safety. The design of WindJet air nozzles prevents dead-ending should the nozzle accidentally be placed against a flat surface
- The targeted air stream delivered by the nozzles can improve the effectiveness and efficiency of drying and blow-off. More complete drying, even in cracks and crevices is commonly achieved



AIR CONSUMPTION: OPEN PIPE VS. AIR NOZZLES

Size [mm]	Open Pipe		Equivalent Impact Using Flat Fan or Round Spray Pattern Air Nozzles	Air Consumption Reduction %
	Size [mm]	Air Consumption at 5 bar (0,5 MPa) [Nm³/h]		
4		54	1	25 %
6		120	2	28 %
8		270	4	33 %
10		342	7	34 %
12		516	7	35 %
16		900	12	36 %
20		1320	12	40 %

NOISE COMPARISON: OPEN PIPE VS. AIR NOZZLES

Pressure	Noise Level		Noise Reduction	Perceived Noise Reduction
	4 mm open pipe at a distance of 1.5 m	Flat Fan or Round Spray Pattern Air Nozzles		
1 bar (0.1 MPa)	70 dBa	63 dBa	7 dBa	38 %
2 bar (0.2 MPa)	80 dBa	70 dBa	10 dBa	50 %
3 bar (0.3 MPa)	84 dBa	74 dBa	10 dBa	50 %
4 bar (0.4 MPa)	88 dBa	76 dBa	12 dBa	56 %
5 bar (0.5 MPa)	92 dBa	80 dBa	12 dBa	56 %
6 bar (0.6 MPa)	98 dBa	85 dBa	13 dBa	60 %
7 bar (0.7 MPa)	98 dBa	85 dBa	13 dBa	60 %

Note: Data is based on AA727 and AA707 WindJet air nozzles.

## WINDJET LOW FLOW AIR KNIVES: OVERVIEW

When space is limited and the process cannot tolerate any increase in temperature, WindJet low flow air knives that use compressed air are an excellent option.

This style air knife delivers a high velocity, uniform air flow across the entire length of the knife. Drying and blow-off are fast and efficient and minimal air is used. Compared to a 3" (8 cm) pipe with three drilled holes, a 3" (8 cm) WindJet low flow air knife will use approximately 92% less air.

Another appealing attribute of low flow air knives is the noise level. Noise is under 70 dBA in many applications – lower than many compressed air options.

Designed for small areas, low flow air knives are typically mounted close to the target. Maximum knife length (or combined length of all knives) is limited to less than 2' (61 cm). Applications that only require one or two air knives can experience significant operating cost reductions by using WindJet low flow models.

Benefits of low flow air knives include:

- Efficient – minimal air use
- High velocity, uniform air flow
- Low noise level
- Low profile for ease of mounting

## AIR CONSUMPTION: OPEN PIPE VS. LOW FLOW AIR KNIVES



Open Pipe/Drilled Holes in Pipe*			Equivalent Impact Using Low-Flow Air Knives	Air Consumption Reduction %
Quantity	Size [mm]	Air Consumption [Nm <sup>3</sup> /h]		
3	4	96.8	1 (57070-3)	92 %
6	4	193.7	1 (57070-6)	
12	4	387.4	1 (57070-12)	
18	4	581.0	1 (57070-18)	
6	6	417.9	1 (57070-6)	89 %
12	6	835.9	1 (57070-12)	

## WINDJET AIR AMPLIFIERS: OVERVIEW

A WindJet variable air amplifier is another option when using compressed air. Air amplifiers produce a constant, high velocity air stream for very targeted drying and blow-off applications. Efficiency is maximized because additional free air is pulled through the unit along with the compressed air. Variable air amplifiers typically provide coverage in the ¾ to 4" (19.1 to 101.6 mm) range at a distance of 6" (152.4 mm). Commonly used for spot drying, blow-off and exhaust operations, WindJet variable air amplifiers are ideally suited to robotic applications as well.

Benefits of using WindJet variable air amplifiers include:

- Extremely efficient use of compressed air – up to 90% less than open pipes and 60% less than air nozzles
- Delivers higher volumes of air and operates at higher pressures than air nozzles for fast drying and blow-off
- Low noise

## AIR CONSUMPTION: OPEN PIPE VS. AIR AMPLIFIERS

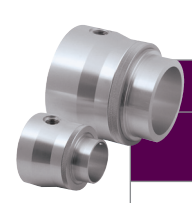

Open Pipe		Equivalent Capacity Using Air Amplifiers	Air Consumption Reduction %
Size [mm]	Air Consumption [Nm <sup>3</sup> /h]		
4	32.3	1 (57080-075)	78 %
6	69.7	1 (57080-075)	86 %
8	159.7	1 (57080-125)	87 %
10	200.5	1 (57080-125)	89 %
12	300.7	1 (57080-200)	89 %
16	524.0	1 (57080-400)	90 %

\* Spaced at 1" intervals.

**AA727 WINDJET NOZZLE**

- Generate efficient, controlled flat fan air pattern for a uniform spray distribution
- Designed to maintain spray pattern integrity
- Available in materials that withstand high temperatures
- New PVDF material for food contact (EC1935/2004) is available. In addition to the actual plastic, it has metal particles, which offers an enormous safety advantage over other plastics. Even very small parts of this plastic are recognized by metal detectors (the metal detectors must be configured and calibrated correctly). The material is FDA compliant.
- Recessed orifices protect against external damage and offer air escape should the nozzles accidentally be placed against a flat surface
- Low noise levels
- Can be mounted side-by-side for air curtain applications

**AA707 WINDJET NOZZLE**

- Produce tightly directed round spray pattern
- Low noise levels
- Color-coded caps for easy identification of flow rates (only for Aluminum version)
- Recessed orifices

**Y767 COMPACT WINDJET NOZZLE**

- Short profile – less than half the height of the AA727
- When installing multiple nozzles on a header, a uniform impact air stream is provided without lowering pressure
- Low noise levels

**QUICK REFERENCE GUIDE**

Nozzle Type	Connection	Connection Type [NPT/BSPT]	Available Material	max. Operating Temperature
AA727	M	1/4"	Polyphenylene sulfide (RY)	82 °C at 7 bar (0.7 MPa)
			Stainless steel (SS)	260 °C at 10.3 bar (1.03 MPa)
			PVDF (KY)	130 °C at 7 bar (0.7 MPa)
			ABS plastic	82 °C at 7 bar (0.7 MPa)
AA727	M or F	1/4"	ABS plastic	82 °C at 7 bar (0.7 MPa)
Y727	M	1/4"	Aluminum (AL)	230 °C at 7 bar (0.7 MPa)
AA707	M	1/4"	Polyphenylene sulfide (RY)	204 °C at 8.6 bar (0.86 MPa)
			PVDF (KY)	104 °C at 8.6 bar (0.86 MPa)
			Aluminum (AL)	230 °C at 8.6 bar (0.86 MPa)
			Stainless steel (SS)	230 °C at 8.6 bar (0.86 MPa)
Y767	M	1/4"	ABS plastic	82 °C at 8,6 bar (0.86 MPa)
			Stainless steel (SS)	65 °C at 3 bar (0.3 MPa) 200 °C at 3 bar (0.3 MPa)



PERFORMANCE DATA

Connection	Nozzle Type	Capacity Size	Capacity [Nm³/h]			
			0.7 bar (0.07 MPa)	2 bar (0.2 MPa)	4 bar (0.4 MPa)	6 bar (0.6 MPa)
1/4 (AG, IG)	AA727 AA727-F	11	8.5	14.8	23.8	32.9
		15	11.6	21.4	35.2	49.0
		23	16.8	30.6	51.1	71.9
1/4 (AG)	Y727-AL	15	11.6	21.4	35.2	49.0
1/4 (AG)	AA707	11 (= Cap Color Green)	8.8	15.9	26.5	36.7
		15 (= Cap Color Yellow)	10.9	20.7	34.7	48.6
		23 (= Cap Color Red)	17.6	31.8	53.3	74.2
1/4 (AG)	Y767	15	11.6	21.4	35.2	49.0

DIMENSIONS + WEIGHTS

Diagram	Nozzle Type	A [mm]	B [mm]	Weight* [g]
	AA727 (AG)	91	51	18–116
	Y727 (AG)	91	51	56
	AA727 (IG)	91	51	18
	AA707 (AG)	48	25	9–45
	Y767 (AG) Version ABS Version 316SS	43 40	41 42	7 48

Based on largest/heaviest version of each type.  
 \* = Depending on material  
 \*\* = Dia. of mounting hole for WindJet AA727 Male version: 4.8 mm. (Not for Y727-AL).

Material Code
None = ABS plastic
-AL = Aluminum
-RY = Polyphenylene sulfide
-SS = Stainless Steel
-KY- ... -FC = PVDF (food contact) with metall particles

ORDERING INFORMATION - AA727 & AA707

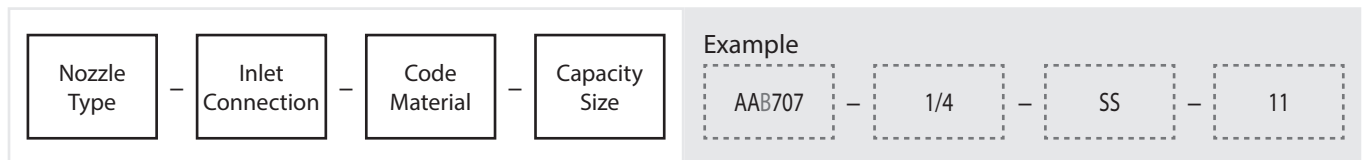

BSPT connections require the addition of a "B". Example: AAB707.

Add an -FC in the end for Food Contact Version (only available in PVDF)

ORDERING INFORMATION - Y727 & Y767

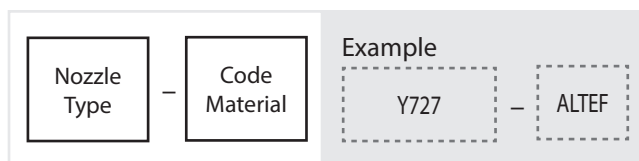

UNIJET NOZZLE UNIT

- UniJet Nozzle Unit with Tip TB contains:  
Body (Type T or Type TT), Tip and Retainer
- Deliver a wide, uniform flat spray pattern

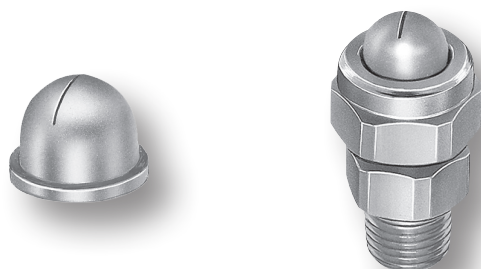

QUICK REFERENCE GUIDE

Tip Type	Connection	Connection Size (in.)	Material
L	1/8" 1/4" 3/8" F or M	1/8" 1/4" 3/8" 1/2"	Brass (none), Stainless Steel (SS)
P			
Q			
R			
U			
V			

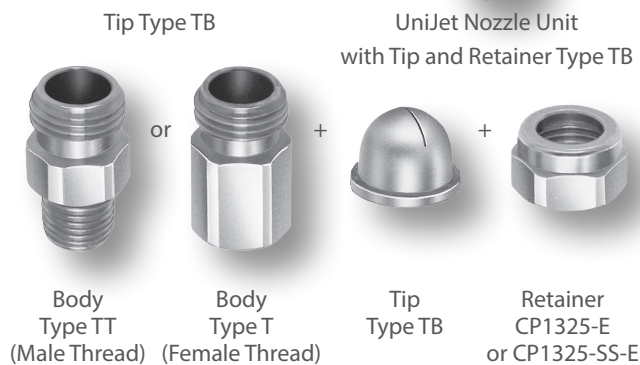

PERFORMANCE DATA

Tip Type	Width of slot [mm]	Capacity Air [Nm <sup>3</sup> /h]				Capacity Steam [kg/h]				Coverage at 150 mm distance to nozzle	
		0.7 bar	2 bar	4 bar	6 bar	1 bar	2 bar	4 bar	7 bar	1 bar	4 bar
L	0.20	1.0	2.5	4.1	5.6	0.8	1.4	2.3	3.7	275	419
P	0.33	2.0	3.8	6.1	8.4	1.5	2.1	3.6	5.5	152	254
Q	0.58	3.7	7.4	12.1	16.7	2.8	4.0	6.8	11.5	228	330
R	1.10	6.6	12.4	21.4	29.6	4.7	7.1	12.3	19.5	158	241
U	1.10	10.7	21.7	35.7	48.4	7.6	12.0	20.3	32.0	275	368
V	2.30	21.7	43.4	71.0	95.5	15.3	25.0	42.0	63.0	238	343

DIMENSIONS + WEIGHTS

Body Type + Tip	Length (mm)	Width (mm)	Weight (g)
T + Tip	48	21	6
TT + Tip	48	21	6

Based on largest/heaviest version of each type.

ORDERING INFORMATION BODY (INCLUDES RETAINER)

Connection	Material	Type Female	Type Male
1/8"	Brass	B1/8T	B1/8TT
	Stainless Steel	B1/8T-SS	B1/8TT-SS
1/4"	Brass	B1/4T	B1/4TT
	Stainless Steel	B1/4T-SS	B1/4TT-SS
3/8"	Brass	B3/8T	B3/8TT
	Stainless Steel	B3/8T-SS	B3/8TT-SS
1/2"	Brass	B1/2T	B1/2TT
	Stainless Steel	B1/2T-SS	B1/2TT-SS

**Material Code**  
None = Brass  
SS = Stainless Steel

ORDERING INFORMATION UNIJET NOZZLE UNIT (TIP TB)

Ordering No. Body + Type Tip - Material Code

Example: B1/4TT-SS + L - SS

ORDERING INFORMATION UNIJET TIP ONLY

Type Tip - TBL-SS

Standard: BSPT, for NPT connections leave the „B“ away.



FLOODJET® K NOZZLES

- One-piece design for easy installation
- Features wide-angle flat spray pattern with medium velocity
- Large round orifice and unobstructed flow passages minimize clogging
- Precision-machined deflector provides accurate control of deflection and spray angle
- Very wide deflected, low impact flat spray pattern
- One piece nozzle construction
- Nozzle capacities to 850 NI/min
- Inlet connections: 1/8", 1/4" or 3/8" NPT(M) or BSPT(M)
- Materials: Brass, 303 Stainless Steel, 316 Stainless Steel or PVC



PERFORMANCE DATA

Inlet Connection NPT or BSPT			Capacity Size	Orifice Dia [mm]	Capacity Air [NI/min]			Capacity Steam [kg/h]			Coverage at 150 mm	
1/8	1/4	3/8			0.7 bar	1.5 bar	3.5 bar	0.7 bar	1.5 bar	3.5 bar	0.7 bar	3.5 bar
●			0,50	0.61	4.5	6.4	11.6	0.16	0.23	0.41	51	127
●			0,75	0.71	6.2	9.1	16.7	0.23	0.33	0.60	64	140
●			1	0.84	9.6	13.7	25	0.34	0.49	0.90	76	152
●			1,5	1.04	15.3	22	40	0.54	0.78	1.5	89	165
●	●		2	1.17	19.3	28	51	0.68	1.0	1.8	102	190
●	●		2,5	1.32	27	37	71	0.95	1.3	2.5	102	190
●	●		3	1.45	31	47	85	1.1	1.7	3.0	127	203
●			4	1.65	40	57	108	1.4	2.0	3.9	127	228
●	●		5	1.85	54	76	139	1.9	2.7	5.0	152	267
●	●		7,5	2.31	79	117	210	2.9	4.2	7.6	152	267
●	●		10	2.64	110	159	290	3.9	5.7	10.4	178	279
●	●		15	3.28	181	260	475	6.5	9.3	17.1	178	305
●	●		20	3.76	225	325	590	8.0	11.6	21	216	368
		●	30	4.57	320	465	850	11.6	16.8	30	216	394

DIMENSIONS & WEIGHTS

Inlet Connection NPT or BSPT	Length (mm)	Width (mm)	Weight (g)
1/8 (M)	25	11	15
1/4 (M)	31	14	30
3/8 (M)	45	18	60

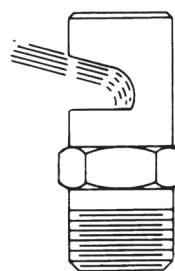

Based on largest/heaviest version of each type.  
M = Male connection type

Material Code
None = Brass
SS = 303 Stainless Steel
316SS = 316 Stainless Steel
PVC = Polyvinyl Chloride

ORDERING INFORMATION

FLOODJET K COMPLETE NOZZLE

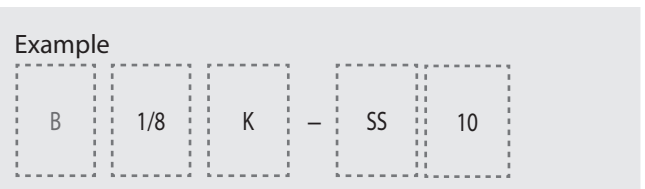
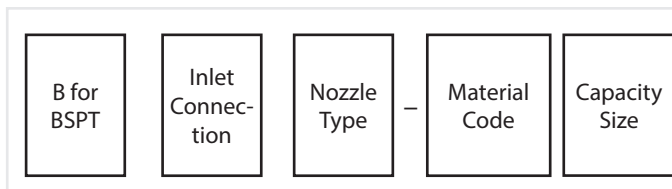

B denotes BSPT connection. No code is needed for NPT connection.

**LU-HK : ROUND SPRAY NOZZLES (CIL, MULTI-CHANNEL)**

- Quiet and powerful, Economical air consumption
- Uniform spray distribution of particularly high blowing force
- Working Pressure: 2 – 8 bar (0.2 – 0.8 MPa)
- Threads: G1/4"
- Material: Brass or Stainless Steel
- Also available with additional hole
- For use on hand guns, on extension tubes and flexible hoses

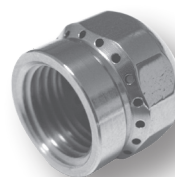

LU-HK  
Round Spray Nozzles  
(CIL, Multi-Channel)

**LU-VK : ROUND SPRAY NOZZLES (HIGH-PERFORMANCE, MULTI-CHANNEL)**

- Low noise levels, powerful
- Economic air consumption at a particularly high blowing force
- Working Pressure: 2 – 8 bar (0.2 – 0.8 MPa)
- Thread: 1/2" and 3/4" BSPT or NPT
- Material: Brass or Stainless Steel
- External dia. from 25 mm

LU-VK  
Round Spray Nozzles  
(High-Performance, Multi-Channel)



**LU-VS : SPOT NOZZLE (MULTI-CHANNEL)**

- Quiet, powerful, resistant
- Smooth, economical air consumption at high blowing force
- Types: Standard Type 201295 + 070813 and Ball Type 221295
- Working Pressure: max. 10 bar (1.0 MPa)
- Material: Brass, Stainless Steel or Aluminum
- Thread: – Female: M7x0.75 (Type 201295)  
– Female: G1/4" (Type 070813)  
– Male: M12x1.25 or G1/4" (Type 221295)
- Adapter for Type 201295 + 070813 available

LU-VS  
Spot Nozzle (Multi-Channel)  
Type 221295



LU-VS  
Spot Nozzle (Multi-Channel)  
Type 201295 + 070813



**Y737 WINDJET NOZZLE**

- Superior blow-off performance with straight round pattern
- Multiple orifices are equally spaced along the circumference of the nozzle tip to provide high impact air stream
- Available in 3 air flow levels with the choice of inlet connections from threaded or half union types
- Material: Chrome-plated brass
- Max. Operating Temperature: 130 °C
- Max. Pressure: 7 bar (0.7 MPa)

Y737-2PipeConnectionType



Y737-2ThreadedConnectionType



Y737-19ThreadedConnection  
Type  
(with 19 orifices)



**QUICK REFERENCE GUIDE**

Type	Number of Orifices	Thread	Air Consumption [Nm <sup>3</sup> /h]			
			2 bar (0.2 MPa)	5 bar (0.5 MPa)	7 bar (0.7 MPa)	8 bar (0.8 MPa)
LU-HK 191295-40	–	G1/4"	23	45	62	71
LU-VK 040196-130	–	G1/2"	61	122	166	188
LU-VK 291295-40	–	G1/2"	26	51	69	79
LU-VK 070797-230	–	G3/4"	113	233	322	371
LU-VK 070797-250			123	251	350	405
LU-VK 070797-340			165	243	–	–
LU-VK 070797-470			234	478	–	–
LU-VK 070797-530			286	533	–	–
LU-VS 201295-18	–	M7x0.75	9	18	26	30
LU-VS 221295-20	–	M12x1.25 or G 1/4"	11	20	29	35
LU-VS 070813-90	–	G1/4"	43	90	123	139
Y737-19	19	R1/4	12	25	35	--
Y737-1	8	Thread R1/4" or R3/8"	22	45	56	--
Y737-2	6	or Pipe Ø 6.0 or 8.0 mm	17	33	43	--

DIMENSIONS + WEIGHTS

\*= Optional with smaller or larger dimensions available  
 \*\*= Weight varies depending on the material

		Type	A [mm]	B [mm]	C [mm]	D [mm]	Weight [g]
		LU-HK 191295-40*	18	18	16	-	6
		LU-VK 040196	29	25	23	-	42
		LU-VK 291295	29	25	23	-	35
		LU-VK 070797	42	40	35	-	210
		LU-VS 201295-18	20,5	8	13,5	-	3**
		LU-VS 070813-90	39	15	25	-	7**
		LU-VS 221295-20	40	25	9	10	64**
		Y737-19	26	HEX 14	15	-	13
		Y737-1-1/4 Y737-1-3/8 Y737-2-1/4 Y737-2-3/8	32	HEX 17	16	-	30 33 30 33
		Y737-1-6.0 Y737-1-8.0 Y737-2-6.0 Y737-2-8.0	58	HEX 17	16	-	67 69 66 68

ORDERING INFORMATION

LU-HK

Type	Size	Material	Example LU-HK 191295 - 40 - MS
------	------	----------	-----------------------------------

LU-VK

Type	Size	Material	Example LU-VK 070797 - 230 - MS
------	------	----------	------------------------------------

LU-VS – Standard Type 201295 + 070813

Type	Size	Material	Example LU-VS 201295 - 18 - MS
------	------	----------	-----------------------------------

Note:  
Ordering No. Adapter  
for Standard Type 201295:

- BDN-1/8-M7x0.75-1.4305-040796
- BDN-1/4-M7x0.75-ALU-050101
- BDN-G1/4-M7-0.75-MS-050101
- BDN-G1/4-M7x0.75-1.4305-050101
- BDN-G1/4

LU-VS – Ball Type

Type	Size	Material	Example LU-VS 221295 - 20 - MS
------	------	----------	-----------------------------------

Y737

Nozzle Type	Inlet Connection	Code Material	Example Y737-2 - 8.0 - CRP
-------------	------------------	---------------	-------------------------------

**LU-BR  
BLOWING RING**

- All Blowing Rings have nozzles arranged centrally to the middle for a high blowing power with a annular spray pattern.
- Also available as a folding version (two piece design) - easy threading assembly.
- Working pressure up to 8 bar (0.8 MPa)
- Air consumption at 5 bar (0.5 MPa): 113-644 Nm<sup>3</sup> / h
- Material blowing ring: Aluminum. Others on request.
- Material nozzles: ABS, PPS, PVDF, brass, aluminum, Stainless steel
- Thread: G3/8" + G3/4"
- Available with various nozzles and different diameters

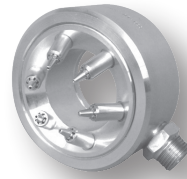

Version with 6 Nozzles:  
LU-BR 080796  
LU-BR 301097



Version with 8 Nozzles:  
LU-BR 010504  
LU-BR 251197



Version with 12 Nozzles  
LU-BR 020504  
LU-BR 130297



Folding Version  
(with 6 Nozzles)  
LU-BR 110297

**QUICK REFERENCE GUIDE**

Type & Size	Inlet Connection	Numbers of Nozzles	Air Consumption [Nm <sup>3</sup> /h]		
			2 bar (0.2 MPa)	4 bar (0.4 MPa)	6 bar (0.6 MPa)
LU-BR 110297-108 (Folding Version)	G1/4"	6 x LU-VS201295-18	54	90	126
LU-BR 301097-108	G3/8"	6 x LU-VS201295-18	54	90	126
LU-BR 080796-108	G3/8"	6 x LU-VS201295-18	54	90	126
LU-BR 251197-144	G3/8"	8 x LU-VS201295-18	72	135	189
LU-BR 010504-144	G3/4"	8 x LU-VS201295-18	72	135	189
LU-BR 130297-216	G3/4"	12 x LU-VS201295-18	108	180	252
LU-BR 130297-130	G3/4"	12 x AAB707-¼-11	192	324	444
LU-BR 130297-486	G3/4"	12 x AAB707-¼-15	253	420	588
LU-BR 130297-644	G3/4"	12 x AAB707-¼-23	384	636	888
LU-BR 020504-216	G3/4"	12 x LU-VS201295-18	108	180	252
LU-BR 020504-367	G3/4"	12 x AAB707-¼-11	192	324	444
LU-BR 020504-486	G3/4"	12 x AAB707-¼-15	252	420	588
LU-BR 020504-644	G3/4"	12 x AAB707-¼-23	384	636	888

DIMENSIONS + WEIGHTS

	Type	Ø A [mm]	Ø B [mm]	C [mm]	Ø D [mm]	Weight* [g]
	LU-BR 110297 (Folding Version)	99	46	35	60	400
	LU-BR 301097	79	28	35	40	290
	LU-BR 080796	99	48	35	60	360
	LU-BR 251197	119	68	35	80	420
	LU-BR 010504	139	88	35	100	800
	LU-BR 130297	179	90	50	120	1200
LU-BR 020504	199	105	50	140	1450	

\*= Based for material Aluminum. Data for other materials on request.

ORDERING INFORMATION

Blowing Ring Type	Material Blowing Ring	Size	Material of Nozzle	Example
				LU-BR 130297 - ALU - 130 - ABS

WINDJET LOW FLOW AIR KNIVES

- Ideal for applications using 1 or 2 air knives
- Provide a uniform air flow across the entire length of the knife
- Deliver a high velocity, constant air stream for fast drying and blow-off
- Reduce energy use
- No temperature increase
- Use minimal air
- Maintenance-free; no moving parts
- Lower noise levels, 69 dBA for most applications
- Easy to install and maintain
- Compact and designed for small areas
- 316 stainless steel available for sanitary applications
- Available shim sets to adjust air force and flow. Shim set includes automatic drain filter with a 40 micron filter element sized properly for flow



WindJet Low Flow Air Knives

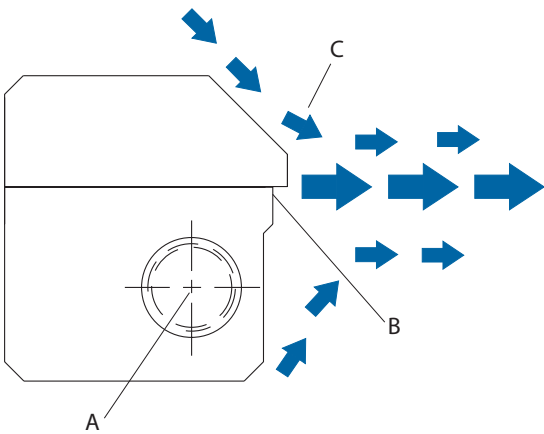

WindJet Low Flow Air Knives produce a high velocity, constant air stream for optimal performance of your drying and blow-off process. Compressed air flows through an inlet (A) where it is directed to the orifice. The primary air flow exits the thin slotted nozzle orifice across the length of the knife (B) creating a uniform sheet of air. For added force, secondary air is entrained along the edge of the knife (C). The end result is a highly uniform, constant air stream with hard-hitting force.

QUICK REFERENCE GUIDE

Type	Air Knife Standard Lengths	Connection Size	Shims [mm]	Material	max. Operating Temperature
57070	3" = 76 mm 6" = 152 mm 12" = 305 mm 18" = 457 mm 24" = 610 mm	1/4"	Standard 0.05  Optional 0.03 0.08 0.10	Aluminum (AL) with Plastic (PETP) shim  316 Stainless Steel (316SS) with 316SS shim	at 13.8 bar (1.38 MPa) 60 °C Aluminum 93 °C Stainless Steel

PERFORMANCE DATA

Supply Pressure bar [MPa]	Air Consumption per 25 mm [Nm <sup>3</sup> /h]	Velocity @ 6" (150 mm) from orifice [m/s]	Impact per Inch (25 mm) @ 6" (150 mm) from target [g]
1.4 (0.14)	1.56	26.9	15
2.8 (0.28)	2.69	35.6	31
4.1 (0.41)	3.90	48.8	53
5.5 (0.55)	5.10	63.5	75
6.9 (0.69)	6.30	72.1	95

WindJet Low Flow Air Knife with .002" thick shim installed.

DIMENSIONS + WEIGHTS

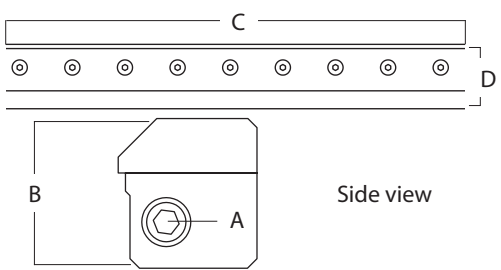
	Shim Sizes [mm]	A	B [mm]	C [mm]	D [mm]	Weight Alu [g]	Weight Stainless Steel [g]
	0.03 0.05 0.08 0.10	1/4" NPT or BSPT	42	76	39	250	830
		42	152	39	535	1926	
		42	305	39	1060	3812	
		42	457	39	1590	5719	
		42	610	39	2060	7410	

ORDERING INFORMATION

WINDJET LOW FLOW AIR KNIFE

Type	Knife Length	Material Code	Example
			B57070 - 12 - 316SS

BSPT connections require the addition of a "B". Example: B57070.

Material Code
AL = Aluminum
316SS = 316 Stainless Steel
PETP = Plastic

Length Code
3" = 76 mm
6" = 152 mm
12" = 305 mm
18" = 457 mm
24" = 610 mm

WINDJET LOWFLOW AIRKNIFE KIT (INCL. ACCESSORIES)

Part No.	Knife Length	Material Code	Example
			B57060 - 12 - 316SS

Includes an air knife, shim set, filter, pressure regulator and pressure gauge.

SHIM SET

Part No.	Knife Length	Material Code	Example
			57075 - 12 - PETP

Includes one each of .001" (.03 mm), .003" (.08 mm) and .004" (.10 mm) thick shims.

WINDJET VARIABLE AIR AMPLIFIERS

- Ideal for spot drying, blow-off and exhaust applications
- Deliver a targeted high volume, high velocity amplified air stream for fast drying and blow-off
- Save on air consumption while providing higher volumes of air
- Maintenance-free; no moving parts
- Low noise levels – meets OSHA pressure and noise requirements
- Easy to install and maintain
- Adjustable model available for easier maintenance and setting of air amplification
- Kits available with an automatic drain filter with a 50 micron filter element sized properly for flows
- Pressure regulator sized properly for flow is available

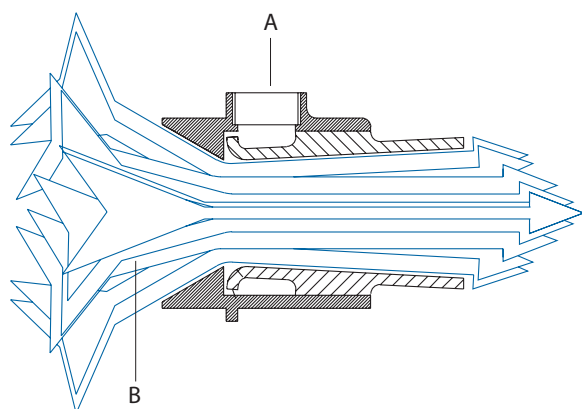
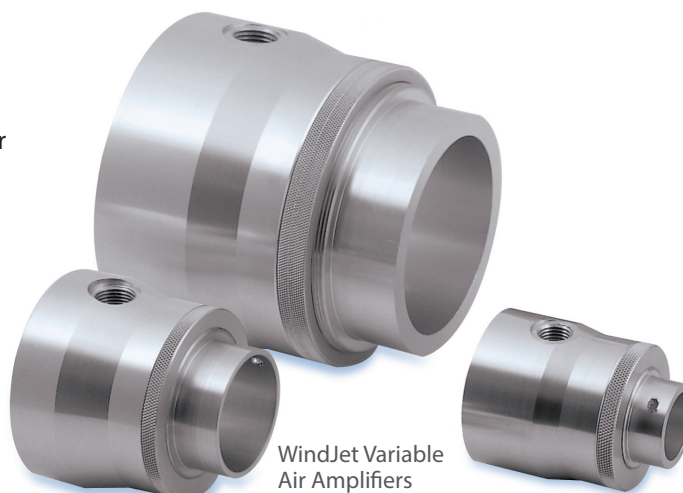

Intensifying precise amounts of compressed air, WindJet Variable Air Amplifiers produce a constant, high velocity air stream for very targeted drying and blow-off applications. Along with the compressed air (A), additional free air (B) is pulled through the unit, resulting in maximum air amplification.

QUICK REFERENCE GUIDE

Type	Connection	Connection Size	Outlet ODs [mm]	Material
57080-075	F	1/8"	19	Aluminum (AL), 316 stainless steel (316SS)
57080-125	F	1/4"	32	Aluminum (AL), 316 stainless steel (316SS)
57080-200	F	3/8"	51	Aluminum (AL), 316 stainless steel (316SS)
57080-400	F	1/2"	102	Aluminum (AL), 316 stainless steel (316SS)



PERFORMANCE DATA

Type	Inlet Connection Size	Air Consumption at 5,5 bar (0,55 MPa) [Nm <sup>3</sup> /h]	Amplification Ratio	Air Volume at Outlet [Nm <sup>3</sup> /h]
57080-075	1/8"	15.8	10	158.0
57080-125	1/4"	22.2	16	355.1
57080-200	3/8"	36.4	20	727.3
57080-400	1/2"	85.4	24	2050.9

DIMENSIONS + WEIGHTS

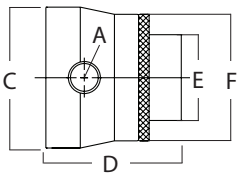
Side View 	Type	A	B [mm]	C [mm]	D [mm]	E [mm]	F [mm]	Weight Alu [g]	Weight Stainless Steel [g]
	57080-075	1/8"	11.4	38.1	57.2	19.1	31.8	89	260
57080-125	1/4"	21.6	50.8	73.7	31.8	44.5	204	590	
57080-200	3/8"	41.9	79.4	82.6	50.8	69.9	560	1600	
57080-400	1/2"	76.2	127.0	127.0	101.6	114.3	2200	6400	

ORDERING INFORMATION

WINDJET AIR AMPLIFIERS

Type - Material Code **Example**  
B57080 - 075 - 316SS



Air Amplifier Kit

**Material Code**  
 AL = Aluminum  
 316SS = 316 Stainless Steel

**Connection Code**  
 1/8" = 075  
 1/4" = 125  
 3/8" = 200  
 1/2" = 400

WINDJET AIR AMPLIFIER KIT

Type - Connection Code - Material Code **Example**  
B57085 - 075 - 316SS

WindJet Air Amplifier Kit includes air amplifier, filter, pressure regulator and pressure gauge.

BSPT connections require the addition of a "B". Example: B57085.

**MODEL 11438 AIR LINE FILTER**

- Removes liquid and solid contaminants from air lines
- Automatic or manual drain
- Protects equipment from corrosion and excessive wear
- Maximum operating pressure: 10 bar
- Maximum temperature: 50 °C



**MODEL 11438 AIR PRESSURE REGULATOR**

- Diaphragm-type air pressure regulator
- Balanced valve design in two styles: relieving and non-relieving
- Relieving automatically relieves excessive pressure in a regulated air line
- Non-relieving requires some other means of relief to reduce trapped pressure
- Body and bonnet material: die cast aluminum, zinc, or stainless steel



Main Port NPT (IG)	Gauge Ports (F)	Type	
		Relieving	Non-Relieving
1/4"	1/4"	11438-45	11438-35
3/8"	1/4"	11438-46	11438-36
1/2"	1/4"	11438-47	11438-37
3/4"	1/4"	11438-48	11438-38
1"	1/4"	11438-49	11438-39

**MODEL 26383 PRESSURE GAUGE**

- Offers stable, accurate needle readings up to the rated maximum pressure
- Center back connection 1/4" NPT (M)
- Maximum pressure ranges: 4.2 to 11 bar



Type	Inlet connection [M]	Max. Pressure bar [MPa]	Opt. Operation Range bar [MPa]
26383	1/4"	4.2 (0.42)	1.0–3.1 (0.10–0.30)
		6.9 (0.69)	1.7–5.2 (0.17–0.52)
		11.0 (1.10)	2.8–8.3 (0.28–0.83)

**2-WAY SOLENOID VALVE**

- Designed for automatically operated systems requiring on/off flow
- Air and liquid temperature ranges: 5 °C to 75 °C
- Features UL and CSA approved ten-watt, class "F" coils for continuous duty
- Ambient operating temperatures: -10 °C to 50 °C
- Coils rated for dual frequency operation and international use
- Resists high humidity and fungus growth
- Electric connection: 1/2" NPT

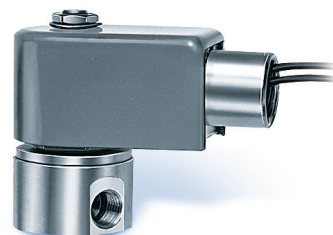

**PERFORMANCE DATA**

F = Female Thread / M = Male Thread

Main Port NPT (F)	Model	Ventil-Action	Max. Pressure bar [MPa]	Orifice Size [mm]	Cv Factor **	Body Material	Seal Material
1/4"	11438-20	Direct Acting Poppet	4 (0.4)	4.8	0.40	Stainless Steel	Viton®
1/4"	11438-21		14 (1.4)	3.2	0.28		Kel-F®
3/8"	11438-22	Pilot-Operated Diaph.	10 (1.0)	11.0	2.5	Brass (Forged or cast brass)	Buna-N
1/2"	11438-23		10 (1.0)	16.0	4.0		
3/4"	11438-24		16 (1.6)	19.0	9.5		
1"	11438-25		16 (1.6)	25.0	13.0		

\* For maximum pressures of coils "C" and "D", ask for Data Sheet 11438 - Solenoid (1). \*\* For use of Cv Factor, ask for Data Sheet 11438 - Solenoid (2).

Viton® is a registered trademark of DuPont Performance Elastomers. Kel-F® is a registered trademark of 3M Company.

**STAY-N-PLACE HOSES AND MAGNETIC MOUNTING BASES**

- Easy-to-use, flexible source of targeted air that is changeable from application to application
- Complete control for targeted, precise air blow-off
- Once the hose is positioned in place, it will not move or relax its position
- Build your own configuration to fit your unique applications
- Work with a variety of air control and standard spray nozzles
- The magnetic base, with built-in valves, can be mounted vertically or horizontally
- Bendable hoses won't move once set in place
- Use with both air and liquid



**QUICK REFERENCE GUIDE – STAY-N-PLACE HOSES**

Type	Connection*	Connection Size	Length	max. Operating Temperature	max. Operating Pressure bar [MPa]	max. Operating Flow
57025	M x M	1/4" x 1/4"	6" = 15 cm 12" = 30 cm 18" = 46 cm	Air: 121 °C Liquid: 93 °C	8.6 (0.86)	at 8.6 bar (0.86 MPa) 934 NI/min
57020	M x F	1/4" x 1/4"	24" = 61 cm 30" = 76 cm 36" = 91 cm			

\* F = Female Thread / M = Male Thread

**ORDERING INFORMATION**

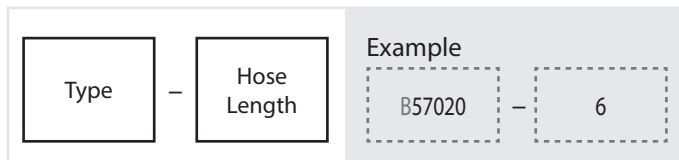

BSPT connections require the addition of a "B". Example: B57020.

**MAGNETIC MOUNTING BASE**

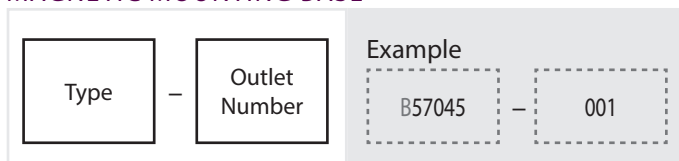

Single (001) or double (002) outlet models available.

BSPT connections require the addition of a "B". Example: B57045.

WINDJET AIR MANIFOLDS 46760 & 39190

- Delivers a uniform distribution across the impact/blow-off area
- Flat fan pattern with very high impact offers higher impact than blower-type air knives
- With a simple operating pressure adjustment, impact can be increased from moderate to very high



Type 39190

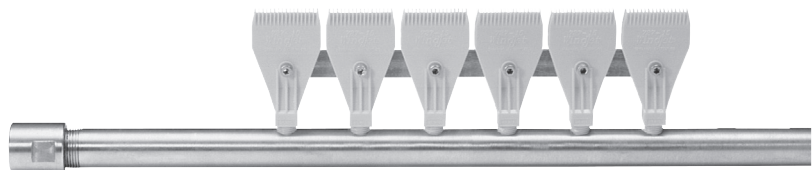

Type 46760

QUICK REFERENCE GUIDE

	Type 46760	Type 39190
Coverage	200 - 1500 mm	203 and 406 mm
Material	Pipe: Aluminum WindJet Nozzles: ABS	Pipe: White Nylon WindJet nozzles: ABS
Operating Pressure	0.35 - 7 bar	max. 7 bar
Inlet Connection	3/4", 1" or 1-1/4" NPT(F) or BSPT(F)	3/4", 1" or 1-1/4" NPT(F) or BSPT(F)
Max. Temperature	82 °C	50 °C

DIMENSIONS

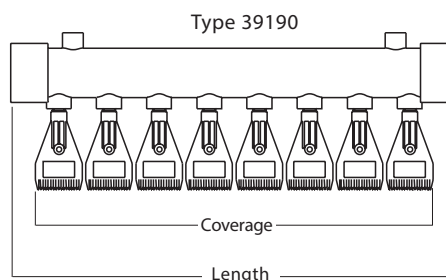
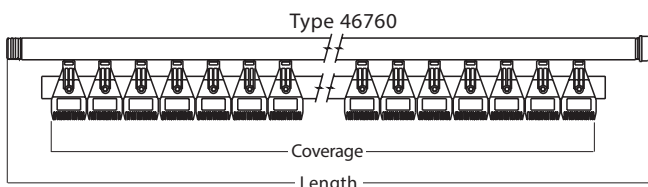

PERFORMANCE DATA

Type	Pipe Size	Number of 727-15 WindJet Nozzles	Capacity (NI/min)					Overall Length (mm)	Coverage (mm)
			0.7 bar	2 bar	3 bar	4 bar	6 bar		
46760	3/4"	4	772	1428	1880	2344	3264	520	200
		6	1158	2142	2820	3516	4896	520	300
		12	2316	4284	5640	7032	9792	920	600
	1"	16	3088	5712	7520	9376	13056	1120	800
		20	3860	7140	9400	11720	16320	1320	1000
	1-1/4"	24	4632	8568	11280	14064	19584	1520	1200
30		5790	10710	14100	17580	24480	1720	1500	
39190	1"	4	772	1428	1880	2344	3264	254	203
	1-1/2"	8	1544	2856	3760	4680	6528	451	406

**WINDJET AIRKNIFE LU-ZU**

- Uniform vaulting across entire width by V-shaped arrangement of the nozzles (as in a snow plow). As a result, liquid can be blown off and transported to the sides
- Nozzle protection on request
- Custom design: Individually construction according to the different needs
- Material pipe construction: Stainless steel or Aluminum
- Material WindJet Nozzles Type 727: Aluminum, PPS or ABS

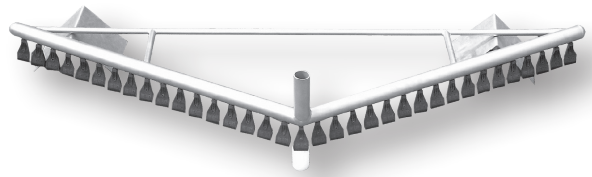

AirKnife LU-ZU

**BLOWING STRIP WITH SPOT NOZZLES LU-VS**

- Pipe length: Variabel
- Pipe: 1/2" Ø 21.3 x 2.5 mm
- Total height including nozzles: ca. 44 mm
- Pipe material: Stainless Steel (1.4301)
- Nozzle material: Aluminum. Optional also brass or stainless steel
- Pressure: max. 10 bar (1.0 MPa)



Blowing Strip

**ORDERING EXAMPLE PIPE:**  
FT-LUF-xxxxx-Material Code

**ORDERING EXAMPLE SPOT NOZZLE LU-VS:**  
LU-VS 201295-18-Material Code

Air Consumption (per nozzle) [Nm <sup>3</sup> /h]		
2 bar (0.2 MPa)	5 bar (0.5 MPa)	8 bar (0.8 MPa)
9	18	30

More information view page 18 + 19.

CUSTOMIZED MANIFOLDS: CHECK FOR DETAILS WITH YOUR LOCAL SALES OFFICE

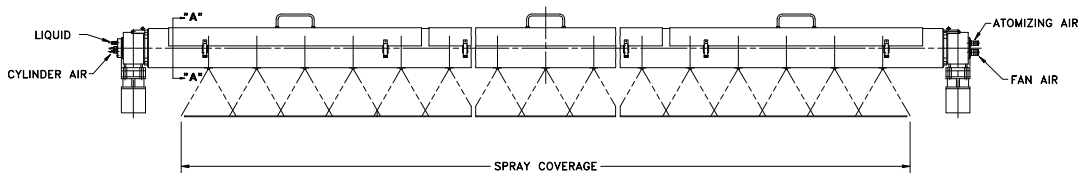

OPTIMIZATION BEGINS WITH PROPER SELECTION

There are four main characteristics that should be considered when selecting air nozzles – effective spray coverage, sound lineal impact force and specific impact force. The following information provides selection guidelines but it is always best to consult with a local sales engineer.

EFFECTIVE SPRAY COVERAGE

Spray coverage is the width of the spray pattern for a flat fan air nozzle. Effective spray coverage is the width of the fan, which comprises a minimum spray force measurement. This coverage can be used as a guide for spacing nozzles. Effective spray coverage varies for different types of air nozzles. In general, effective coverage generally increases as distance from the nozzle increases.

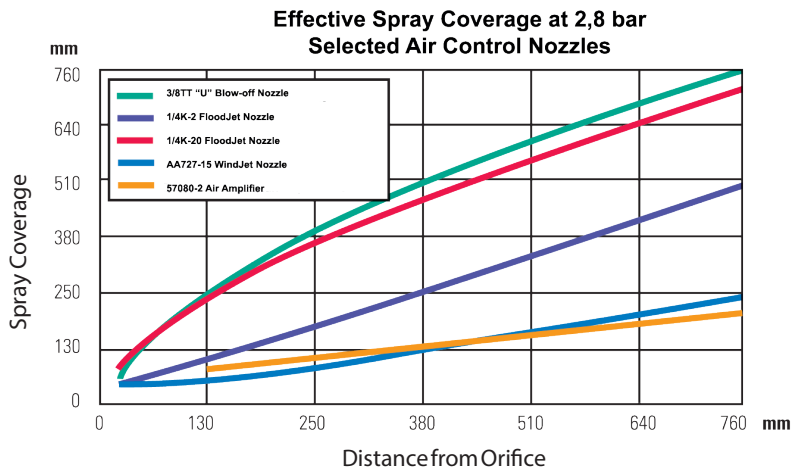

SOUND LEVEL

Capacity, air pressure and how the nozzle is positioned all impact noise. Higher flow rates and higher pressures generally increase noise levels. Obstructions in the nozzle’s path or spraying against objects will also increase sound levels.

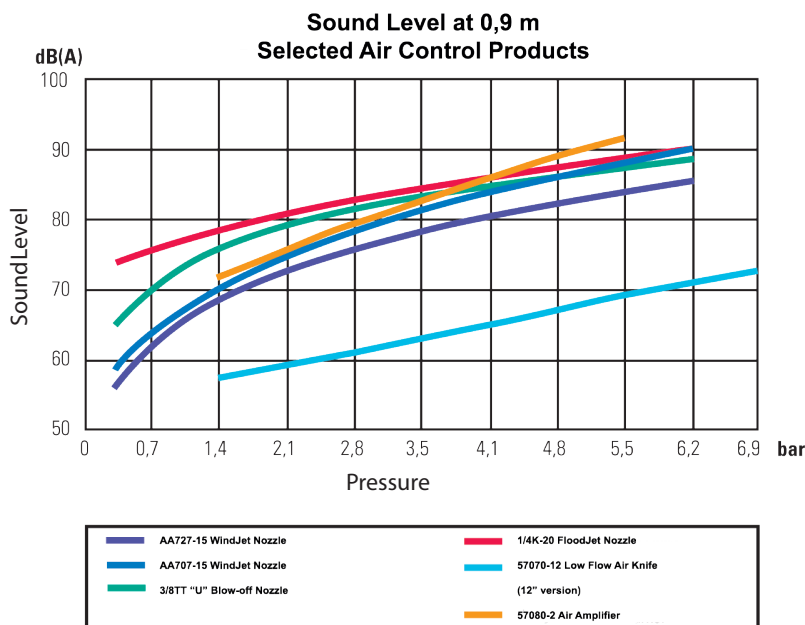

## LINEAL AND SPECIFIC IMPACT FORCE

There are two types of impact to consider when selecting air nozzles: lineal impact and maximum specific impact.

Lineal impact indicates relative force per unit distance across the spray width. Flat spray patterns have fairly uniform impact distribution across the effective spray coverage. Spacing of nozzles in a header according to the effective spray coverage will provide consistent lineal impact across the entire target surface.

Maximum specific impact is a direct indication of spray intensity applied to a surface. It provides maximum force per unit area information, which can be used to compare spray effectiveness under various conditions.

In general, both lineal and specific impact increase with pressure. A nozzle with a narrower coverage will have greater impact than one with a wider coverage.

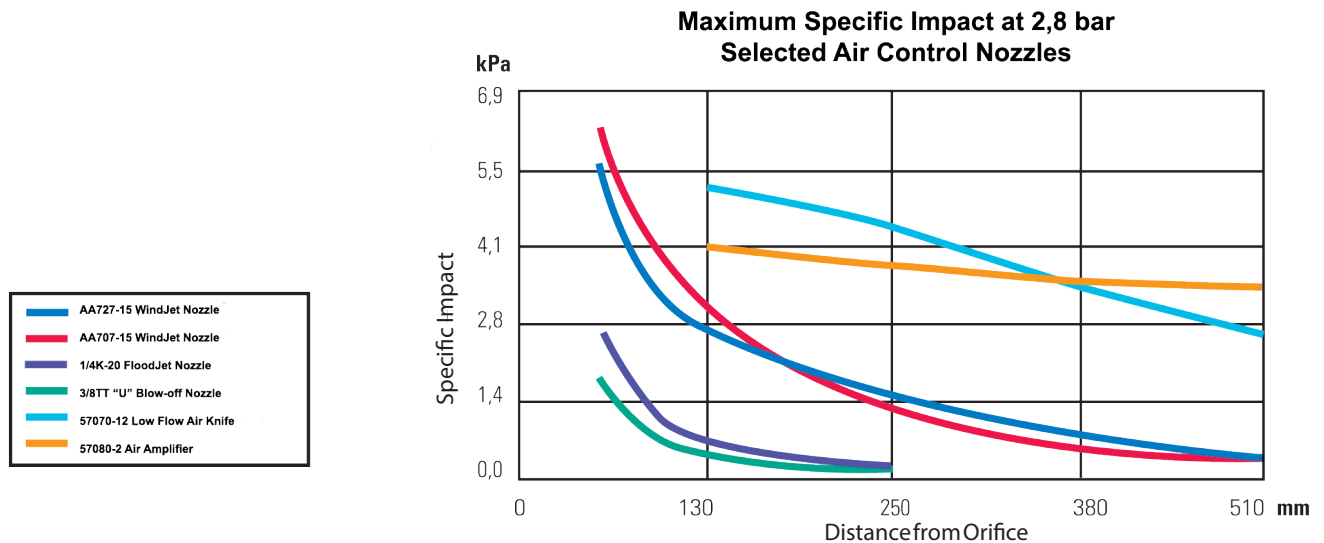
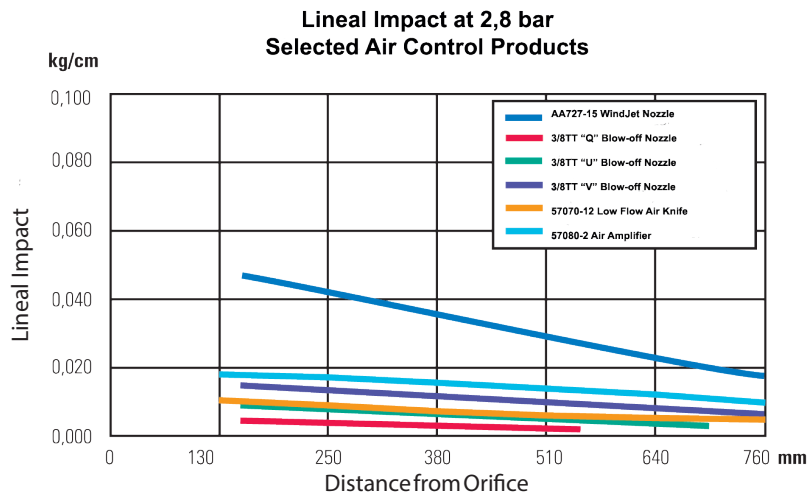

## PERFORMANCE-ENHANCING TIPS

- To minimize air consumption and reduce noise, specify the lowest-flow nozzle
- To reduce noise caused by air impacting its target, increase the distance between the nozzle and the target when possible
- To reduce the number of nozzles required, position nozzles to swipe sideways across a moving target at a comparatively shallow angle
- When creating an air curtain, place nozzles up to 12" (305 mm) apart
- When using air nozzles for cleaning, angle the nozzles 15° to 45° to ensure contaminant removal
- Proper filtration of compressed air is important. Use a filter/separator to remove excess oil and water just prior to the nozzles
- Use a pressure regulator and gauge on the air line to keep pressure as low as possible to minimize operating costs and noise and improve safety
- For simple, accurate adjustment of nozzle orientation, install adjustable ball joints with air nozzles

## REPRESENTATIVES & MANUFACTURING SITES

Spraying Systems Co. - Austria

Tel: +43 732 77 65 40  
E-Mail: info.at@spray.com

Spraying Systems Co. - Belgium

Tel: +32 2 425 01 75  
E-Mail: info.be@spray.com

Spraying Systems Co. - Czech Rep. MT Spray - Denmark

Tel: +420 543 217 405  
E-Mail: info.cz@spray.com

Tel: +45 4454 0454  
E-Mail: mt-spray@mt-spray.dk

Spraying Systems Co. - Finland

Tel: +358 10 336 2000  
E-Mail: info.fi@spray.com

Spraying Systems Co. - France

Tel: +33 1 46 20 96 40  
E-Mail: info.fr@spray.com

Spraying Systems Co. - Germany

Tel: +49 40 766 001 0  
E-Mail: info.de@spray.com

Spraying Systems Co. - Greece

Tel: +30 6944287075  
E-Mail: info.gr@spray.com

Spraying Systems Co. - Hungary

Tel: +36 70 429 8203  
E-Mail: info.hu@spray.com

Spraying Systems Co. - Italy

Tel: +39 02 38 34 181  
E-Mail: info.it@spray.com

Spraying Systems Co. - Netherlands

Tel: +31 180 330 505  
E-Mail: info.nl@spray.com

Spraying Systems Co. - Norway

Tel: +47 64 95 64 50  
E-Mail: info.no@spray.com

Spraying Systems Co. - Poland

Tel: +48 32 238 81 11  
E-Mail: info.pl@spray.com

EuroControl - Portugal

Tel: +351 214 267 830  
E-Mail: eurocontrol@eurocontrol.pt

Spraying Systems Co. - Romania

Tel: +40 021 327 49 86  
E-Mail: info.ro@spray.com

Spraying Technologies LLC - Russia

Tel: +7 495 797 62 67  
E-Mail: info.ru@spray.com

Spraying Systems Co. - Spain

Tel: +34 91 357 40 20  
E-Mail: info.es@spray.com

Spraying Systems Co. - Sweden

Tel: +46 26 17 65 50  
E-Mail: info.se@spray.com

Spraying Systems Co. - Switzerland

Tel: +41 55 410 10 60  
E-Mail: info.ch@spray.com

Spraying Systems Co. - Turkey

Tel: +90 212 274 21 55  
E-Mail: info.tr@spray.com

Spraying Systems Co. - United Kingdom

Tel: +44 1252 727200  
E-Mail: info.uk@spray.com

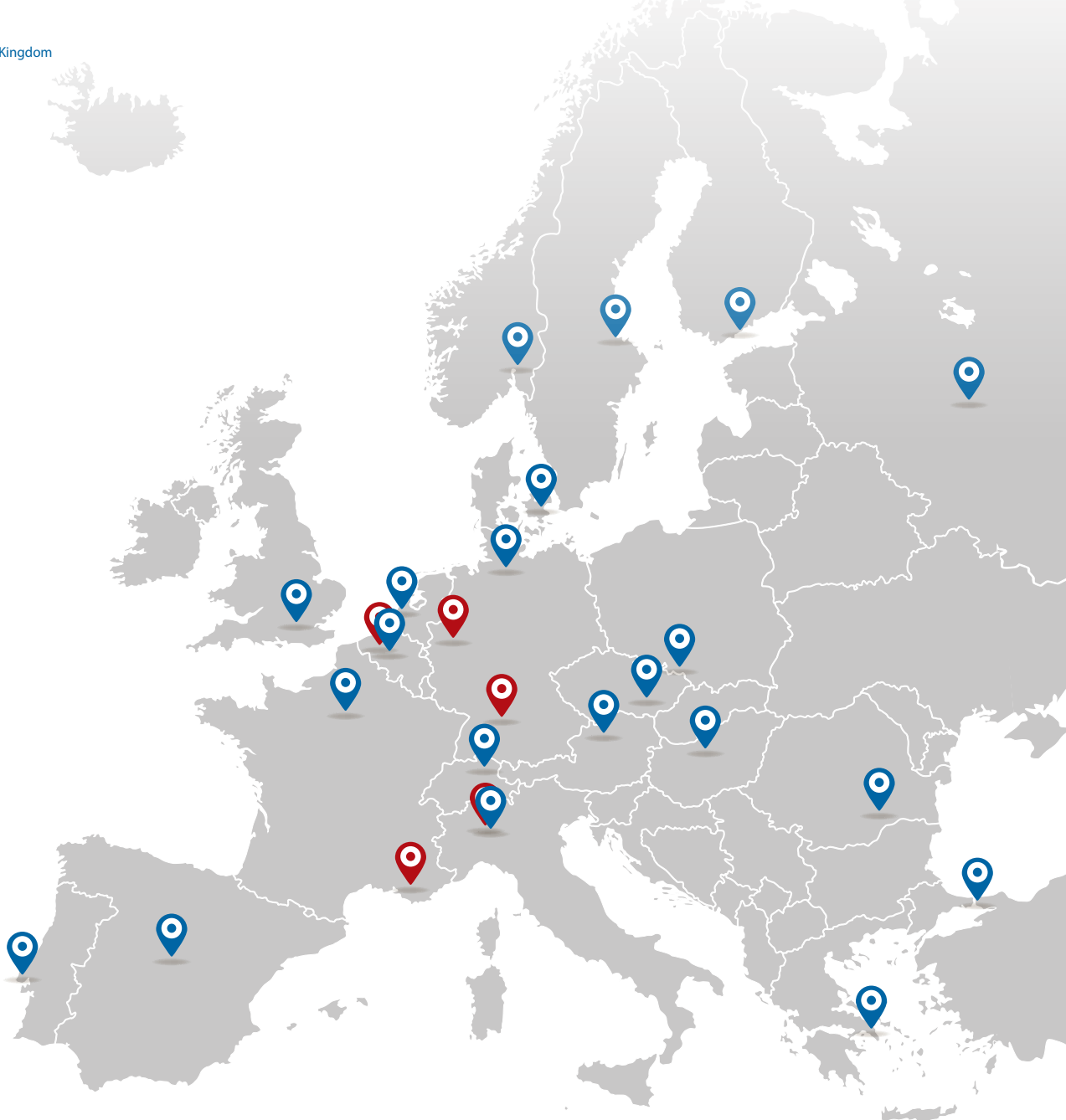

MORE LOCAL REPRESENTATIVES ON [WWW.SPRAY.COM](http://WWW.SPRAY.COM)

