



ACCESSORIES



ACCESSORIES INTRODUCTION



OPTIMIZE PERFORMANCE AND SIMPLIFY INSTALLATION

Simplify Nozzle Mounting and Positioning

- Split-eyelet connectors
- Adjustable ball fittings
- Adjustable hoses and mounting bases

Options for Quick-Connect Nozzle Systems

- Strainers
- Flow stabilizers
- Metering plates
- Color-coded caps

Ensure Proper Flow Control and Regulation

- Check valves, throttling valves, pressure relief valves and more
- Air pressure regulators
- Liquid pressure regulators

Clog Prevention

- Liquid strainers
- Filtration assemblies
- Air line filters

SIMPLIFY INSTALLATION, OPERATION AND MAINTENANCE

Prevent particles and debris from obstructing flow with **nozzle and fluid line strainers**.

Choose from a wide range of inlet connections, materials, mesh size and more.

See pages F4 and F16



Connect nozzles to pipes in minutes with leak-proof **split-eyelet connectors**.

Connectors clamp on 1/2" to 2" pipes.

See page F23



Easily control line pressure and minimize waste with **adjustable relief valves**. Excess liquid is returned back to the liquid source or pump inlet.

See page F31



ACCESSORIES

TABLE OF CONTENTS

STRAINERS

	PAGE
TWD, 16106, 9830 and AA122 strainers	F4
AA124/AA430 strainers	F5
15925, 8310A and 2820 strainers	F5

FILTRATION ASSEMBLY AND AIR LINE FILTERS

	PAGE
39185 filtration assembly	F10
11438 air line filters	F10

QUICK-CONNECT NOZZLE SYSTEM OPTIONS: ADAPTERS

	PAGE
QJ17560A, QJ7421, QJ1/4TT and QJ1/4T adapters	F12

QUICK-CONNECT NOZZLE SYSTEM OPTIONS: UNIJET® BODIES

	PAGE
4664B and 8360 diaphragm check valve bodies	F14
7421 split-eyelet bodies	F14

QUICK-CONNECT NOZZLE SYSTEM OPTIONS: UNIJET® STRAINERS AND FILTER

	PAGE
5053, 6051, 8079 and 4193A strainers	F16
4514, 4067 and 7630 strainers	F16
9106 filter	F16

QUICK-CONNECT NOZZLE SYSTEM OPTIONS: UNIJET® STABILIZER, VALVE, RETAINER, PLATE AND ADAPTERS

	PAGE
11370 jet stabilizer	F18
11750 large capacity check valve	F18
CP1325 tip retainer	F18
4916 metering plate	F18
4676 and 6406 adapters	F19

QUICK-CONNECT NOZZLE SYSTEM OPTIONS: QUICK UNIJET® ADAPTER AND CAPS

	PAGE
QJT adapter and caps	F21

SPLIT-EYELET CONNECTORS AND ADJUSTABLE BALL FITTINGS

	PAGE
7521, 8370 and 15475 split-eyelet connectors	F23
36275 adjustable ball fittings	F23

CHECK VALVES

	PAGE
AB and BB ball-type check valves	F26
10742A and 12328 diaphragm check valves	F26
CV series check valves	F26

PLUG AND BALL VALVES

	PAGE
23220 plug valves	F29
20900 ball valves	F29

THROTTLING AND PRESSURE RELIEF/REGULATING VALVES

	PAGE
23120, 8460, 6815, 110 and 23520 valves	F31

SOLENOID VALVES

	PAGE
2-way and 3-way valves	F34

LIQUID AND AIR PRESSURE REGULATORS

	PAGE
11438 regulators	F36

LIQUID PRESSURE GAUGES

	PAGE
26383 and 26385 gauges	F38

HOSES AND MOUNTING BASES

	PAGE
57020 and 57025 stay-n-place hoses	F39
57045 magnetic mounting bases	F39



OVERVIEW: LIQUID STRAINERS

- Liquid strainers protect nozzles, valves and pumps from damaging debris and minimize clogging
- Wire mesh options ensure screening of particulate as small as 63 microns

T-Style Strainer

T-strainers feature a removable bottom cap or plug for complete withdrawal of the screen assembly during cleaning. On some models, the bottom pipe plug can be replaced with a drain cock for quick-flush cleaning. Models with a clear nylon bowl allow easy visual inspection of the internal screen. Self-clean designs allow filtered liquid to pass through, while liquid particles are returned back to the liquid supply through a return outlet.

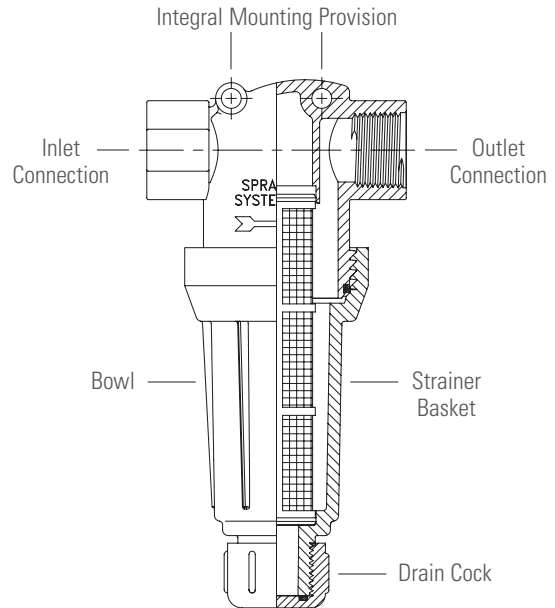

STRAINER OPTIONS

TWD

1/4", 3/8", 1/2", 3/4", 1", 1-1/4", 1-1/2", 2", 2-1/2" female conn.

Removable bottom plug for easy screen cleaning

Bottom plug can be replaced with drain cock for flush cleaning

Max. pressure: 300 psi (20 bar)

Materials: Aluminum, brass, stainless steel

Mesh: 16, 30, 50, 80, 100, 40 x 200 Dutch weave



16106

1-1/2", 2", 2-1/2" female conn.

Removable bottom plug for easy screen cleaning

Bottom plug can be replaced with drain cock for flush cleaning

Max. pressure: 200 psi (14 bar)

Materials: Brass, stainless steel

Mesh: 16, 50, 80, 100



9830

3/4", 1" female conn.

Hand removable ribbed bottom cap for easy cleaning of screen

Max. pressure: 300 psi (20 bar)

Materials: Aluminum, brass, ductile iron

Mesh: 16, 50, 100



AA122

1/2", 3/4" female conn.

Hand removable outer bowl for easy screen cleaning

Max. pressure: 150 psi at 100°F (10 bar at 38°C)

Materials: Polypropylene, polypropylene head with clear nylon bowl

Mesh: 15, 30, 50, 80, 100, 200, 40 x 200 Dutch weave



STRAINER OPTIONS

AA124/AA430

3/4", 1", 1-1/4", 1-1/2", 2", 2-1/2" female conn.*

Larger size screen area requires less frequent cleaning

Self-cleaning styles and versions with mounting lugs available

AA124 and AA430 versions are the same except for materials and inlet connections



Strainer Type	Strainer Part No.	Material**	Max. Pressure	Mesh Sizes
124	AA124-AL	Aluminum head/nylon bowl	150 psi (10 bar)	16, 30, 50, 80, 100
124ML with mounting holes***	AA124ML-AL	Aluminum head/nylon bowl	150 psi (10 bar)	16, 30, 50, 80, 100
124A self-cleaning version	AA124ASC-NYB	Aluminum head/nylon bowl	110 psi (8 bar)	16, 30, 50, 80, 100
430ML with mounting holes***	AA430ML	Polypropylene head/nylon bowl	110 psi (8 bar)	16, 30, 50, 80, 100, 120, 200****
430 self-cleaning version	AA430SC	Polypropylene head/nylon bowl	75 psi (5 bar)	16, 30, 50, 80, 100, 120, 200****

*Inlet connections vary. See pages F8 and F9.

**Max. temperature for plastic 100°F (38°C); max. temperature for metal 180°F (82°C).

***For mounting on machinery or angle iron.

****120 only for 1-1/4" and 1-1/2" sizes; 200 only for 3/4" and 1" sizes.

15925

3/4", 1" female conn.

Removable bottom plug for easy flush cleaning of screen

Max. pressure: 2000 psi at 150°F (138 bar at 66°C)

Material: Black oxide-coated mild steel body

Mesh: 50



8310A

1/4", 3/8", 1/2" female conn.

Removable bottom plug for easy flush cleaning of screen

Max. pressure: 5000 psi at 150°F (345 bar at 66°C)

Material: Stainless steel

Mesh: 16, 30, 50, 100



2820

1/4", 3/8", 1/2" female inlet conn.
1/4" female outlet conn.

Max. pressure: 5000 psi at 150°F (345 bar at 66°C)

Material: Stainless steel

Mesh: 16, 30, 50, 100



MATERIAL

CODE

Aluminum	AL
Brass	B
Ductile Iron	No code
Nylon	NYB
Polypropylene	PP
Polypropylene head/clear nylon bowl	NYC
303 stainless steel	SS
316 stainless steel	316SS

MESH SELECTION GUIDE

Mesh Size	Wire Dia. (in.)	Mesh Opening (in.)	Mesh Opening (microns)	Percentage Open Area	Orifice Dia. (in.)
16	0.016	0.045	1143	55.4	0.032 and larger
20	0.016	0.0340	864	46.2	0.032 and larger
30	0.012	0.0213	541	40.8	0.032 and larger
50	0.009	0.0110	279	30.3	0.032 and larger
60	0.0075	0.0092	234	30.5	0.019 through 0.031
80	0.0055	0.0070	177	31.4	0.019 through 0.031
100	0.0045	0.0055	140	30.3	0.019 through 0.031
120	0.0037	0.0046	118	30.1	0.019 through 0.031
200	0.0021	0.0029	74	33.6	Up through 0.018
40 x 200 Dutch Weave	0.007 x 0.005	0.003	63	–	Up through 0.018

ORDERING INFORMATION

TWD STRAINER

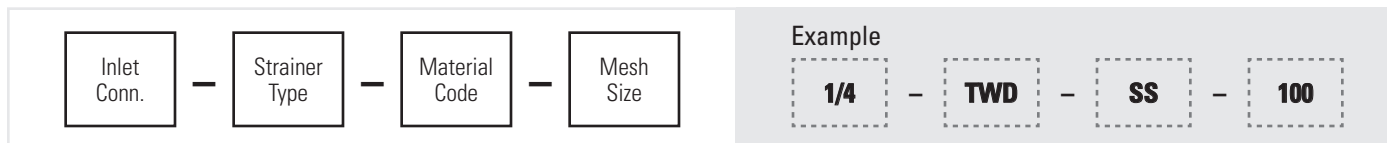

BSPT connections require the addition of a "B" prior to the inlet connection.

16106 STRAINER



BSPT connections require the addition of a "B" prior to the inlet connection.

9830 STRAINER

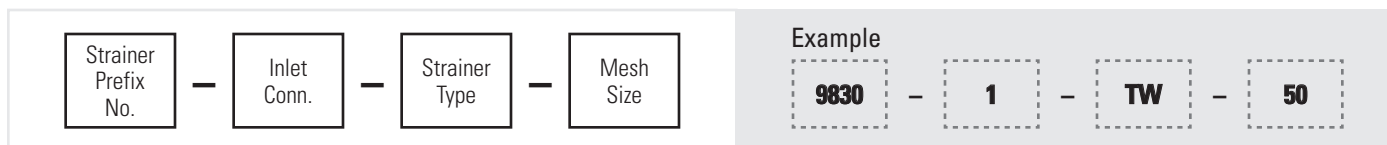

BSPT connections require the addition of a "B" prior to the inlet connection.

AA124 SELF-CLEANING STRAINER



BSPT connections require the addition of a "B" prior to the inlet connection.



ORDERING INFORMATION

15925 STRAINER

<div style="border: 1px solid black; padding: 5px; display: inline-block;">Strainer Type</div> - <div style="border: 1px solid black; padding: 5px; display: inline-block;">Inlet Conn.</div>	<p>Example</p> <div style="border: 1px dashed gray; padding: 5px; display: inline-block; margin-right: 10px;">15925</div> - <div style="border: 1px dashed gray; padding: 5px; display: inline-block; margin-right: 10px;">3/4</div>
---	--

BSPT connections require the addition of a "B" prior to the inlet connection.

8310A STRAINER

<div style="border: 1px solid black; padding: 5px; display: inline-block; margin-right: 10px;">Strainer Type</div> - <div style="border: 1px solid black; padding: 5px; display: inline-block; margin-right: 10px;">Inlet Conn.</div> - <div style="border: 1px solid black; padding: 5px; display: inline-block;">Mesh Size</div>	<p>Example</p> <div style="border: 1px dashed gray; padding: 5px; display: inline-block; margin-right: 10px;">8310A</div> - <div style="border: 1px dashed gray; padding: 5px; display: inline-block; margin-right: 10px;">3/8</div> - <div style="border: 1px dashed gray; padding: 5px; display: inline-block;">100</div>
--	---

BSPT connections require the addition of a "B" prior to the inlet connection.

2820 STRAINER

<div style="border: 1px solid black; padding: 5px; display: inline-block; margin-right: 10px;">Strainer Type</div> - <div style="border: 1px solid black; padding: 5px; display: inline-block; margin-right: 10px;">Inlet Conn.</div> - <div style="border: 1px solid black; padding: 5px; display: inline-block; margin-right: 10px;">Material Code</div> - <div style="border: 1px solid black; padding: 5px; display: inline-block;">Mesh Size</div>	<p>Example</p> <div style="border: 1px dashed gray; padding: 5px; display: inline-block; margin-right: 10px;">2820</div> - <div style="border: 1px dashed gray; padding: 5px; display: inline-block; margin-right: 10px;">1/4</div> - <div style="border: 1px dashed gray; padding: 5px; display: inline-block; margin-right: 10px;">SS</div> - <div style="border: 1px dashed gray; padding: 5px; display: inline-block;">16</div>
---	---

BSPT connections require the addition of a "B" prior to the inlet connection.

DIMENSIONS AND WEIGHTS

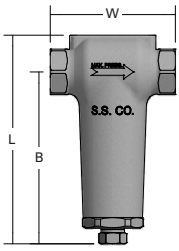
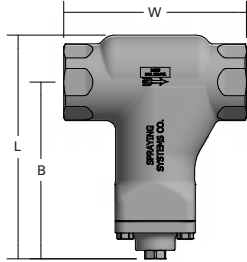
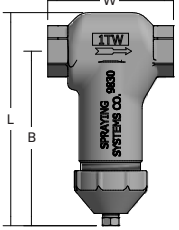
Strainer	Accessory Type	Inlet Conn. (in.)	L (in.)	W (in.)	B (in.)	Net Weight (oz.)
	TWD	1/4	3.922	2.500	3.235	24.9
		3/8	4.905	3.250	3.965	28.2
		1/2	4.905	3.250	3.965	28.2
		3/4	7.535	4.500	6.225	80.4
		1	7.535	4.500	6.225	76.7
		1-1/4	10.320	6.000	8.380	190.2
		1-1/2	10.320	6.000	8.380	183.5
		2	12.365	8.000	9.805	357.8
		2-1/2	12.365	8.000	9.805	334.1
	16106	1-1/2	9.0	7.250	7.240	188.9
		2	11.310	9.250	8.940	416.2
		2-1/2	11.310	9.250	8.940	392.9
	9830	3/4	8.180	5.250	7.187	140.6
		1	8.180	5.250	7.187	136.8

Based on the largest/heaviest version of each type.

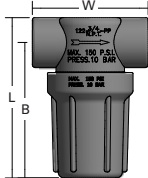
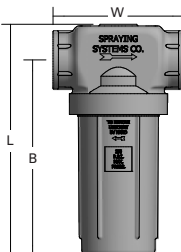
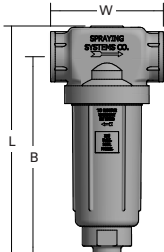
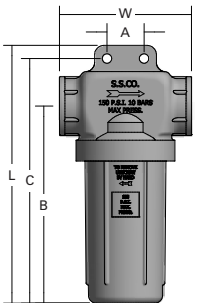
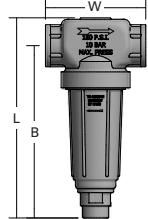

DIMENSIONS AND WEIGHTS

Strainer	Accessory Type	Inlet Conn. (in.)	L (in.)	W (in.)	A (in.)	B (in.)	C (in.)	Net Weight (oz.)
	AA122	1/2	4.014	3.063	–	3.625	–	3.4
		3/4	4.014	3.063	–	3.625	–	3.2
	AA124	1-1/4	9.400	5.344	–	8.020	–	77.2
		1-1/2	9.400	5.344	–	8.020	–	76.9
		2	12.000	7.438	–	10.000	–	215.2
		2-1/2	12.000	7.438	–	10.000	–	204.9
	AA124SC	1-1/4	8.750	5.343	–	7.355	–	53.3
		1-1/2	8.750	5.343	–	7.355	–	52.2
	AA124ML	3/4	7.953	4.188	1	5.891	7.453	31.0
		1	7.953	4.188	1	5.891	7.453	30.3
		1-1/4	9.688	5.344	1.5	7.234	9.156	41.6
		1-1/2	9.688	5.344	1.5	7.234	9.156	39.2
		2	14.480	7.438	2.375	11.234	13.855	107.9
		2-1/2	14.480	7.375	2.375	11.234	13.855	103.0
	AA124ASC	3/4	8.325	4.188	–	7.170	–	52.5
		1	8.325	4.188	–	7.170	–	50.4

Based on the largest/heaviest version of each type.



DIMENSIONS AND WEIGHTS

Strainer	Accessory Type	Inlet Conn. (in.)	L (in.)	W (in.)	A (in.)	B (in.)	D (Dia.) (in.)	Net Weight (oz.)
	AA430ML	3/4	8.855	4.510	1.575	7.955	–	15.2
		1	8.855	4.510	1.575	7.955	–	14.1
		1-1/4	11.791	5.600	1.535	10.534	–	32.5
		1-1/2	11.791	5.600	1.535	10.534	–	33.2
	AA430MLSC	3/4	8.738	4.510	1.575	7.838	–	21.9
		1	8.738	4.510	1.575	7.838	–	21.2
		1-1/4	11.816	5.600	1.535	10.561	–	31.0
		1-1/2	11.816	5.600	1.535	10.561	–	31.7
	15925	3/4	11.660	3.750	–	10.650	–	212.5
		1	11.660	3.750	–	10.650	–	208.7
	8310A	1/4	6.090	2.750	–	5.340	–	76.9
		3/8	6.090	2.750	–	5.340	–	75.8
		1/2	6.090	2.750	–	5.340	–	74.8
	2820	1/4	5.438	–	–	–	1.875	51.0
		3/8	5.438	–	–	–	1.875	51.0
		1/2	5.438	–	–	–	1.875	50.2

Based on the largest/heaviest version of each type.

FILTRATION ASSEMBLY

- Filtration assemblies remove grit, scale and organic solids to help ensure nozzle performance and extend wear life – ideal for industrial and potable water
 - Removes slimy solids and algae from process water without premature loading
 - Extra solids holding capacity provides long service life and reduced maintenance
 - Low pressure drop and exceptional flow capacity
 - No tools required for disassembly or cleaning

39185 Filtration Assembly

3/4" female conn.
 Max. pressure: 125 psi (8.4 bar)
 Max. temperature of element: 190°F (88°C)
 Max. temperature of housing: 120°F (50°C)
 Materials: Clear styrene, acrylonitrile and polypropylene
 Filter sizes: 80, 130 and 300



Filter openings: .007" (18 mm) for 80; .005" (.13 mm) for 130; .002" (.05 mm) for 300.

MATERIAL

CODE

Polypropylene	PP
Polypropylene head/clear nylon bowl	NYC
Clear Styrene Acrylonitrile	SAN

AIR LINE FILTERS

- Air line filters protect equipment from corrosion and excessive wear by removing liquid and contaminants from air lines
 - Manual drain air line filter – simple petcock at the bottom of the bowl enables manual drainage; filter is easily accessible
 - Automatic drain air line filter – for use in inaccessible locations; a float-operated mechanism automatically expels liquid when over a critical level

11438 Air Line Filter

1/4", 3/8", 1/2", 3/4", 1" female conn.
 Manual or automatic drain
 50 micron filter element
 Max. pressure: 150 psi (10 bar)
 Max. temperature: 125°F (50°C)



Air Line Filter No.	Air Line Filter Type		Inlet Conn. (in.)	Approx. Flow at 100 psi*	
	Manual	Automatic		scfm	lpm
11438-1	•		1/4	50	1415
11438-2	•		3/8	50	1415
11438-3	•		1/2	150	4250
11438-4	•		3/4	345	9770
11438-5	•		1	445	12600
11438-16		•	1/4	50	1415
11438-17		•	1/2	150	4250
11438-19		•	1	445	12600

*With 5 psi pressure drop through filter.

11438-1, -2, -3, -16 and -17 have screw-on transparent polycarbonate bowls with bowl guards to prevent breakage. Not suitable for use in systems with air compressors lubricated with fire-resistant synthetics.



ORDERING INFORMATION

39185 FILTRATION ASSEMBLY

Filter Type	—	Inlet Conn.	—	Material Code	—	Filter Size
Example 39185 — 3/4 — SAN — 130						

11438 AIR LINE FILTER

Air Line Filter No.	Example 11438-1
---------------------	--

DIMENSIONS AND WEIGHTS

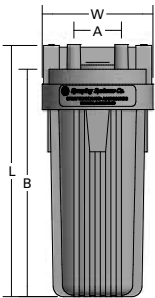
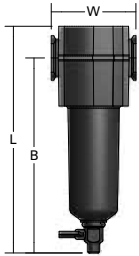
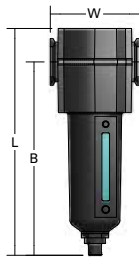
Filtration Assembly/Air Line Filter	Accessory Type	Inlet Conn. (in.)	L (in.)	W (in.)	A (in.)	B (in.)	Net Weight (oz.)
	39185	3/4	12.430	5.130	2.250	10.750	65.8
	11438-1	1/4	6.625	2.750	—	5.938	21.1
	11438-2	3/8	6.625	2.750	—	5.938	17.7
	11438-3	1/2	7.375	3.906	—	6.688	28.8
	11438-4	3/4	11.500	4.750	—	10.438	18.4
	11438-5	1	11.500	4.750	—	10.438	73.8
	11438-6	1-1/2	17.563	8.220	—	15.700	24
	11438-16	1/4	7.000	3.625	—	6.313	21.1
	11438-17	1/2	7.000	3.453	—	6.313	29.4
	11438-19	1	11.125	4.750	—	10.063	73.3

Based on the largest/heaviest version of each type.

OVERVIEW: QUICK-CONNECT NOZZLE SYSTEMS

- Save time cleaning and replacing spray nozzles with quick-connect nozzles. Nozzle bodies stay on header; spray tips are easily removed for cleaning and replacement
 - QuickJet® Nozzle System
 - Install and replace spray tips in seconds – quick-quarter turn is all that is needed
 - Automatic spray tip alignment
 - Integral seals eliminate leaks and stay in place during tip installation and removal
 - Choice of metal or chemically-resistant ProMax® material for use up to 150 psi (10 bar)
 - UniJet® Nozzle System
 - Fast spray tip removal and installation using wrench
 - Metal materials



QuickJet and UniJet nozzles are available in full cone, flat spray and hollow cone spray patterns. See those catalog sections for complete details.

QUICKJET ADAPTERS FOR UNIJET SPRAY TIPS

- QuickJet retaining caps allow easy use of UniJet nozzles
- Split-eyelet versions make connecting spray nozzles to piping systems quick and easy
 - Simply drill a hole in side of pipe
 - Place inlet of split eyelet into the hole; integral seal eliminates leaking
 - Assemble the clamp component to secure the assembly to the pipe
- Compatible with all UniJet spray tips

**QUICK-CONNECT ADAPTER OPTIONS****QJ17560A-NYB**

1/2", 3/4", 1", 20 mm,
25 mm pipe

Positive shut-off with
ChemSaver® check valve

Max. pressure: 300 psi
(20 bar)

**QJ7421-NYB**

1/2", 3/4", 1" pipe

Max. pressure: 300 psi
(20 bar)

**QJ1/4TT-NYB**

1/4" male conn.

Max. pressure: up to 300 psi
(20 bar)

**QJ1/4T-NYB**

1/4" female conn.

Max. pressure: up to 300 psi
(20 bar)



ORDERING INFORMATION

QUICKJET® ADAPTERS QJ17560 AND QJ7421

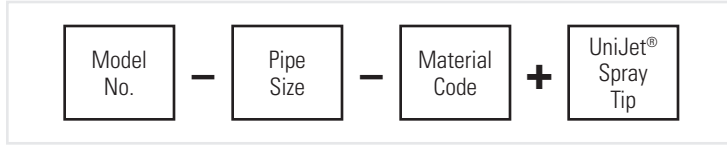

Example



EPDM rubber diaphragm seal standard on QJ17560 and QJ7421. For Viton®, add VI after material code. Example: NYB-VI

QUICKJET ADAPTERS QJ1/4TT AND QJ1/4T

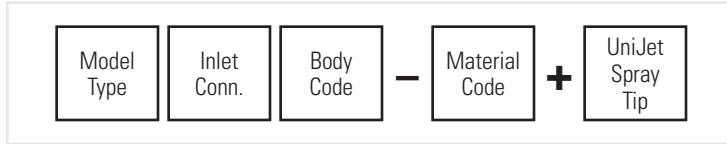

Example



*Additional cap required. See your sales engineer for alternative caps available. BSPT connections require the addition of a "B" prior to the inlet connection.

DIMENSIONS AND WEIGHTS

Adapter	Accessory Type	Inlet Conn. (in.)	Pipe Size (in.)	L (in.)	B (in.)	C (in.)	D (Dia.) (in.)	W (in.)	Hex. (in.)	Net Weight (oz.)
	QJ17560A-NYB	-	1/2	3.62	2.67	1.23	0.840	2	-	1.8
		-	3/4	3.64	2.93	1.23	1.050	2	-	1.8
		-	1	3.74	2.67	1.23	1.315	2.31	-	2
		-	20 mm	3.5	2.66	1.22	0.78	1.88	-	1.7
		-	25 mm	3.7	2.67	1.22	0.98	2	-	1.7
	QJ7421-1-NYB	-	1/2	2.41	1.61	-	0.840	1.67	-	0.9
		-	3/4	2.54	1.64	-	1.050	1.67	-	0.8
		-	1	2.75	1.77	-	1.315	2.54	-	1
	QJ1/4TT-NYB	1/4	-	1-19/32	-	-	0.95	-	3/4	0.3
	QJ1/4T-NYB	1/4	-	1-11/32	-	-	0.94	-	7/8	0.3

Based on the largest/heaviest version of each type.



UNIJET DIAPHRAGM CHECK VALVE NOZZLE BODIES

- Diaphragm design minimizes pressure loss through check valve
- Max. pressure: 300 psi (20 bar)
- Stainless steel valve seat

MATERIAL

CODE

Aluminum	AL
Brass	No code
Nylon	NYB

UNIJET SPLIT-EYELET BODIES

- Quick and easy way to mount UniJet spray nozzles on piping systems
 - Simply drill a hole in side of pipe
 - Place inlet of split eyelet into the hole; integral seal eliminates leaking
 - Assemble the clamp component to secure the assembly to the pipe
- Max. pressure: up to 250 psi (17 bar)
- Max. flow rate: 3 gpm (11.4 lpm)
- Body and clamp materials: Brass, stainless steel

MATERIAL

CODE

Brass	No code
303 stainless steel	SS

UNIJET DIAPHRAGM CHECK VALVE BODY OPTIONS

4664B

1/8" male conn.
Max. flow rate: 1.5 gpm (5.7 lpm)
Materials: Aluminum, brass



8360

1/4" male conn.
Max. flow: 2 gpm (7.6 lpm)
Stainless steel springs:
opening pressures of 2, 5, 8,
15, 20 or 30 psi (0.14, 0.35,
0.55, 1.03, 1.4 or 2.07 bar)
Material: Nylon



7421

1/2", 3/4", 1" pipe size
13/16" to 7/8" (20 to 22 mm),
1 to 1-11/16" (25 to 27 mm) or
1-1/4" to 1-3/8" (32 to 35 mm)
tubing O.D.



ORDERING INFORMATION

8360 UNIJET DIAPHRAGM CHECK VALVE NOZZLE BODY

Model No.	-	Inlet Conn.	-	Body Material Code	-	Diaphragm Material Code	-	Spring Opening Press. (psi)
-----------	---	-------------	---	--------------------	---	-------------------------	---	-----------------------------

Example

8360 -
 1/4 -
 NYB -
 VI -
 20

Spring opening pressure is ordered in psi.

4664B UNIJET DIAPHRAGM CHECK VALVE NOZZLE BODY

Model No.	-	Material Code
-----------	---	---------------

Example

4664B -
 AL

7421 UNIJET SPLIT-EYELET NOZZLE BODY

NOZZLE BODY				SPRAY TIP				
Model No.	-	Pipe Size	-	Body Type	-	Material Code	+	UniJet Spray Tip

Example

7421 -
 1/2
T -
 SS +
 UNIJET SPRAY TIP

DIMENSIONS AND WEIGHTS

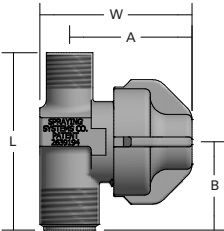
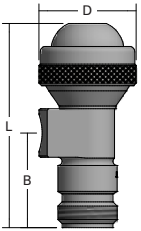
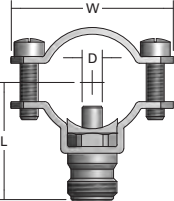
Body	Accessory Type	Inlet Conn. (in.)	Pipe Size (in.)	A (in.)	B (in.)	D (Dia.) (in.)	L (in.)	W (in.)	Net Weight (oz.)
	8360	1/4	-	1.42	1.02	-	2.05	1.76	0.7
	4664B	1/8	-	-	1.1	0.938	2.36	-	3.2
	7421	-	1/2	-	-	0.297	1.375	1.890	3.1
		-	3/4	-	-	0.297	1.625	2.125	2.2
		-	1	-	-	0.297	1.73	2.250	2.3

Based on the largest/heaviest version of each type.

UNIJET STRAINERS AND FILTER

- Use with most standard UniJet and Quick UniJet body assemblies
- In-line design for use at tip
- Low pressure loss
- Easy installation and removal
- Corrosion resistant versions
- Stainless steel mesh; other materials available upon request
- Pair most styles with CP4743 nylon gasket to prevent leaks

Note: Standard UniJet and Quick UniJet nozzles include a strainer. Mesh size is based on orifice diameter. Order strainers separately only if ordering replacement spray tip or if a special version is needed.

FILTER OPTION

9106 Filter

Effective filtration
Higher filtration than other strainers;
300 mesh equivalent
Material: Fused bronze – durable
and corrosion resistant



STRAINER OPTIONS

- 6051** 303 stainless steel
- 5053** brass
- 8079** polypropylene
- Mesh: 24, 50, 100 and 200



4193A

Built-in check valve
Stainless steel springs: opening pressures of
5, 10, 20 or 40 psi (0.35, 0.7, 1.5 or 2.8 bar)
Materials: Aluminum, brass, polypropylene,
303 stainless steel
Mesh: 24, 50, 100, and 200



4514

One-piece design
Slotted design accommodates larger
particulates
Materials: Brass or nylon with 16, 25
or 50 mesh equivalents; aluminum with
16 or 25 mesh equivalents



4067

Cup design for use when space is limited
Material: 303 stainless steel
Mesh: 30, 50, 100 and 200



7630

Disc design for use when space
is extremely limited
Material: 303 stainless steel
Mesh: 30, 50, 100 and 200



MATERIAL

CODE

Aluminum	AL
Brass	No code
Nylon	NY
Polypropylene	PP
303 stainless steel	SS



ORDERING INFORMATION

UNIJET STRAINERS 5053, 6051 AND 8079

Strainer Type	—	Material Code	—	Mesh Size	Example
					6051 — SS — 50

UNIJET STRAINER 4193A

Strainer Type	—	Material Code	—	Spring Opening Pressure (psi)	—	Mesh Size	Example
							4193A — SS — 5 — 50SS

Spring opening pressure is ordered in psi.

UNIJET STRAINER 4514

Strainer Type	—	Material Code	—	Slot Width	Example
					4514 — NY — 10

Use slot width 10 for 50 mesh equivalent; slot width 20 for 25 mesh equivalent and slot width 32 for 16 mesh equivalent.

UNIJET STRAINERS 4067 AND 7630

Strainer Type	—	Mesh Size	Example
			4067 — 200

9106 FILTER

Filter Type	Example
	9106

DIMENSIONS AND WEIGHTS

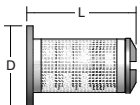
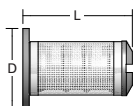
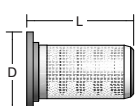
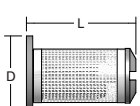
Strainer	Accessory Type	L (in.)	D (Dia.) (in.)	Net Weight (oz.)
	5053	0.81	0.594	1.76
	6051	0.81	0.594	0.03
	8079	0.80	0.594	0.03
	4193A	0.81	0.594	0.37

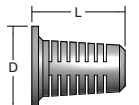
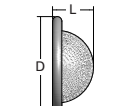
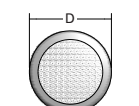
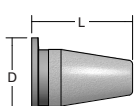
Strainer	Accessory Type	L (in.)	D (Dia.) (in.)	Net Weight (oz.)
	4514	0.66	0.594	0.19
	4067	0.24	0.594	0.19
	7630	0.06	0.594	0.02
	9106	0.75	0.594	0.22

11370 JET STABILIZER

- Install just before the spray nozzle to reduce fluid turbulence
- Helps reduce spray pattern flutter, increase fluid throw distance and increase impact force
- Ideal when nozzles are installed in 90° elbow forcing fluid to change direction
- For use with UniJet flat spray and hollow cone nozzles

11370 Jet Stabilizer

1/8" x 1/8", 1/4" x 1/4", 3/8" x 3/8", 1/2" x 1/2",
 3/4" x 3/4", 1" x 1", 1-1/4" x 1-1/4"
 male inlet conn./female outlet conn.

Materials: Brass, stainless steel



11750 LARGE CAPACITY CHECK VALVE

- Use instead of 4193A for higher flow rates – up to 1.5 gpm (5.7 lpm)
- Prevents dripping from nozzles after line pressure is shut-off
- Compatible with all UniJet spray tips with capacities from 0.4 to 1.5 gpm (1.5 to 5.7 lpm)

11750 Large Capacity Check Valve

Opening pressure: 5 psi (.35 bar)*

Materials: Stainless steel ball and spring; aluminum, brass, polypropylene, stainless steel bodies



*Opening pressure: 10 and 20 psi (0.7 and 1.5 bar) available upon request

CP1325 TIP RETAINER

- Standard nozzle retaining cap for all UniJet style assemblies
- Standard UniJet nozzle and Quick UniJet nozzles include a tip retainer. Order CP1325 when replacement is needed

CP1325 Tip Retainer

Materials: Brass, stainless steel

For high pressure applications, use 7890 tip retainer



4916 METERING PLATE

- Fine-tune flow rate between available nozzle sizes
- Orifice slows fluid; conserves water and may extend wear life

4916 Metering Plate

82 orifice diameters from .008 to .25" (0.2 to 6.35 mm)*

Max. flow rate: 6.9 gpm (26 lpm)

Material: Stainless steel



*Request data sheets 11739, 12417 and 23471-2 for complete information.

UNIJET ADAPTERS

- 4676 Adapter – Use to go from a standard UniJet body to a 1/8", 1/4", 3/8" or 3/4" female outlet
- 6406 Adapter – Use to go from UniJet thread to 1/8" male inlet conn.

ADAPTER OPTIONS

4676 Adapter

11/16"-16 female inlet conn.
Materials: Brass, stainless steel



6406 Adapter

1/8" male outlet conn.
Materials: Aluminum, brass, stainless steel



MATERIAL

CODE

Aluminum	AL
Brass	No code
Nylon	NY
Polypropylene	PP
303 stainless steel	SS

ORDERING INFORMATION

11370 JET STABILIZER



BSPT connections require the addition of a "B" prior to the inlet connection.

11750 LARGE CAPACITY UNIJET CHECK VALVE



Opening pressure is ordered in psi.

CP1325 UNIJET TIP RETAINER

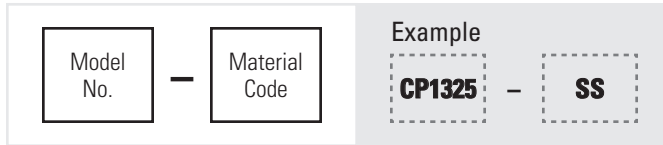

4916 METERING PLATE

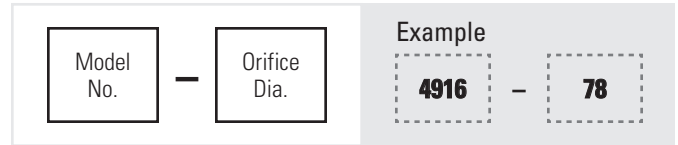

4676 AND 6406 UNIJET ADAPTERS



BSPT connections require the addition of a "B" prior to the inlet connection.

DIMENSIONS AND WEIGHTS

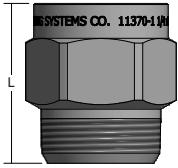
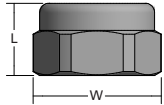
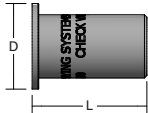
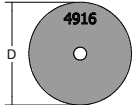
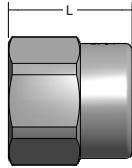
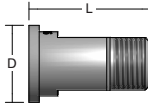
	Accessory Type	Inlet Conn. (in.)	Outlet Thread (in.)	L (in.)	W (in.)	Hex. (in.)	D (Dia.) (in.)	Net Weight (oz.)
	11370 jet stabilizer	–	–	2.219	–	1-7/8	–	36.02
	1325 UniJet tip retainer	–	–	0.500	0.890	13/16	–	0.66
	11750 check valve	–	–	0.797	–	–	0.594	0.36
	4916 metering plate	–	–	–	–	–	0.594	0.02
	4676 adapter	11/16–16	1/8	0.797	–	13/16	–	2.59
		11/16–16	1/4	0.859	–	13/16	–	2.77
		11/16–16	3/8	1.031	–	13/16	–	3.25
		11/16–16	1/2	1.109	–	1	–	5.38
		11/16–16	3/4	1.188	–	1-3/16	–	8.06
	6406 adapter	–	1/8	0.938	–	13/32 flats	0.594	0.64

QUICK UNIJET ADAPTER AND CAPS

- Easily retrofit standard UniJet bodies and GunJet® spray guns to Quick UniJet styles
- Color-coded Quick UniJet caps allows quick identification of nozzles by type or flow rate in same production line
- EPDM gaskets to ensure proper sealing with spray tip. Viton® also available
- Material: Celcon or nylon
- Max pressure: 300 psi (20 bar)

ADAPTER OPTION

QJT-NYB Adapter

Fits 11/16"-16 UniJet thread



COLOR-CODED CAP OPTIONS



All caps are available in all colors. Be sure to specify color code when ordering. Different tip types fit in different caps. See below.

CAP AND TIP COMPATIBILITY

Use with:

- UniJet small capacity flat spray tips, standard sizes through TPU_08
 - Celcon cap only: CP114440A
 - Celcon cap and seat gasket: 114441A
- UniJet large capacity flat spray tips, standard sizes TPU_10 through TPU_20
 - Nylon cap only: CP25609
 - Nylon cap and seat gasket: 25610
- UniJet flat spray tips, sizes through TPU_08. All tips to be positioned parallel or perpendicular to wings of Quick UniJet cap
 - Nylon cap only: CP25595
 - Nylon cap and seat gasket: 25596
- UniJet tips: TC, TG, TK, TN, TPU, T-W and TX
 - Celcon cap only: CP114444A
 - Celcon cap and seat gasket: 114445A
- UniJet tips: Disk and core
 - Celcon cap only: 114444A

ORDERING INFORMATION

QUICK UNIJET CAP AND SEAT GASKET SET

UniJet Cap and Seat Gasket Set	—	Color Code	—	Material Code	Example	114441A	—	3	—	CELR
--------------------------------	---	------------	---	---------------	---------	---------	---	---	---	------

Contact your sales engineer for dimensions and weights.

UniJet Cap and Seat Gasket Set	—	Color Code	—	Material Code	Example	25610	—	3	—	NYR
--------------------------------	---	------------	---	---------------	---------	-------	---	---	---	-----

Contact your sales engineer for dimensions and weights.

QJ46761 cap and seat enables use of standard 1/8" and 1/4" nozzles. Request data sheet 20055 for complete information.

19843-NYR cap and seat provides shut-off at nozzle for quick spacing changes. For use with disc and core type tips. Black only.

QUICK UNIJET CAP ONLY

UniJet Cap	—	Color Code	—	Material Code	Example	CP114440A	—	3	—	CELR
------------	---	------------	---	---------------	---------	-----------	---	---	---	------

UniJet Cap	—	Color Code	—	Material Code	Example	CP25609	—	3	—	NY
------------	---	------------	---	---------------	---------	---------	---	---	---	----

Contact your sales engineer for dimensions and weights.

QUICK UNIJET SEAT GASKET ONLY

Seat Gasket	—	Material Code	Example	CP19438	—	EPR
-------------	---	---------------	---------	---------	---	-----

Contact your sales engineer for dimensions and weights.

Seat Gasket	—	Material Code	Example	CP19438	—	VI
-------------	---	---------------	---------	---------	---	----

For Viton® seal, use VI for material code.

Contact your sales engineer for dimensions and weights.

See Trademark Registration and Ownership, page i-1.

OVERVIEW: SPLIT-EYELET CONNECTORS AND ADJUSTABLE BALL FITTINGS

- Use split-eyelet connectors to provide a quick and easy way to connect spray nozzles to piping systems
 - Simply drill a hole in side of pipe
 - Place inlet of split eyelet into the hole; seal eliminates leaking
 - Assemble the clamp component to secure the assembly to the pipe
- Adjustable ball fitting enables precise control of spray direction. Assemble nozzle into the ball and adjust the orientation of the nozzle. Large internal passages minimize clogging

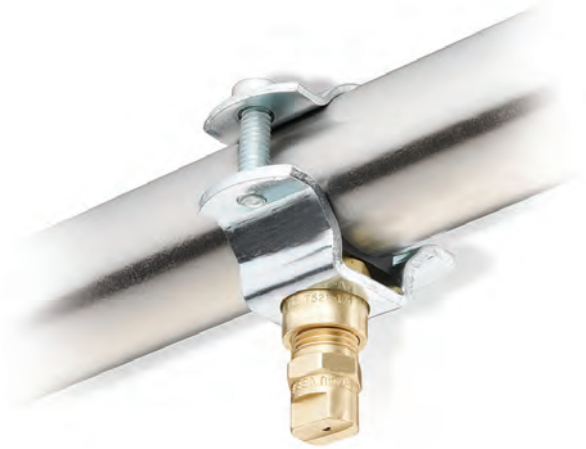

OPTIONS

7521

1/2", 3/4", 1" pipe size
1/8", 1/4" female outlet conn.



8370

1-1/4", 1-1/2", 2" pipe size
1/8", 1/4", 3/8", 1/2" female outlet conn.



15475

2-1/2", 3", 4" pipe size
1/4", 3/8", 1/2", 3/4", 1" female outlet conn.



36275 Adjustable Ball

1/8", 1/4", 3/8", 1/2", 3/4" male inlet conn.
1/8", 1/4", 3/8", 1/2", 3/4" male outlet conn.
45° total included angle of adjustment
Materials: Brass, 303 stainless steel, 316 stainless steel



MATERIAL

CODE

Zinc-plated steel clamps/bolts with brass body	A
All stainless steel	B
Zinc-plated steel clamps/bolts with stainless connector body	C
Stainless steel clamps/bolts with brass body	D

ORDERING INFORMATION

SPLIT-EYELET CONNECTOR



BSPT connections require the addition of a "B" prior to the connector type.

ADJUSTABLE BALL FITTING 36275

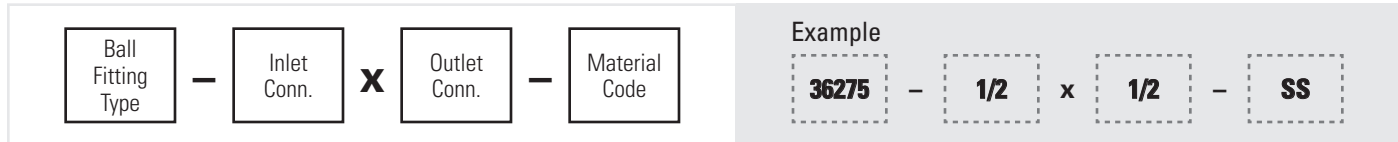

BSPT connections require the addition of a "B" prior to the inlet connection.

SPECIFICATIONS

Split-Eyelet	To Clamp On		Outlet Conn. (F) (in.)						Maximum Pressure psi	Capacity at Maximum Pressure gpm	Material Code
	Pipe Size (in.)	Outside Dia. Tubing (in.)	1/8	1/4	3/8	1/2	3/4	1			
7521	1/2	13/16, 7/8	•	•					250	3.5	A, B, C, D
	3/4	1, 1-1/16	•	•							
	1	1-1/8, 1-1/4, 1-3/8	•	•							
8370	1-1/4	1-9/16, 1-11/16	•	•	•	•			125	5.5-20*	A, B, C
	1-1/2	1-3/4, 2	•	•	•	•					
	2	2-1/8, 2-3/8	•	•	•	•					
15475	2-1/2	2-1/2, 2-7/8		•	•	•	•	•	125	10-54*	A, B, C
	3	3, 3-1/2		•	•	•	•	•			
	4	4, 4-1/2		•	•	•	•	•			

Capacities of 8370 and 15475 Vary with Outlet Conn.	
Outlet Conn. (in.)	Capacity gpm
1/8	5.5
1/4	10
3/8	15
1/2	20
3/4	33
1	54

*Capacities of 8370 and 15475 vary with outlet connection.

Adjustable Ball Fitting	Inlet Conn. (in.)	Outlet Conn. (in.)	Materials
36275	1/8	1/8	Brass (no code), 303 stainless steel (SS), 316 stainless steel (316SS)
	1/4	1/4	
	1/4	1/8	
	3/8	3/8	
	3/8	1/4	

If inlet and outlet connections are different sizes, contact your local sales engineer.

Adjustable Ball Fitting	Inlet Conn. (in.)	Outlet Conn. (in.)	Materials
36275	1/2	1/2	Brass (no code), 303 stainless steel (SS), 316 stainless steel (316SS)
	1/2	1/4	
	1/2	3/8	
	3/4	3/4	

If inlet and outlet connections are different sizes, contact your local sales engineer.

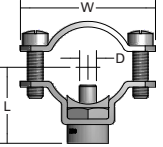
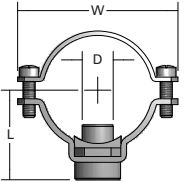
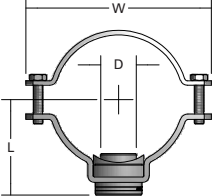

DIMENSIONS AND WEIGHTS

Split-Eyelet	Accessory Type	Pipe Size (in.)	W (in.)	D (Dia.) (in.)	L (in.)	Net Weight (oz.)
	7521	1/2	0.938	0.281	1.108	3.1
		3/4	0.938	0.281	1.213	3
		1	0.938	0.281	1.346	2.3
	8370	1-1/4	1.063	0.688	1.611	6.3
		1-1/2	1.063	0.688	1.731	7
		2	1.063	0.688	1.970	7.4
	15475	2-1/2	1.125	1.250	2.469	9.8
		3	1.125	1.250	2.781	28.9
		4	1.125	1.250	3.281	34.2

Based on the largest/heaviest version of each type.

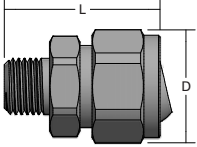
Adjustable Ball	Accessory Type	Inlet Conn. (in.)	Outlet Conn. (in.)	L (in.)	D (Dia.) (in.)	Hex. (in.)	Net Weight (oz.)
	36275	1/8	1/8	1.375	0.969	7/8	2
		1/4	1/4	1.563	1.094	1	3
		1/4	1/8	1.563	1.094	1	3.1
		3/8	3/8	1.781	1.375	1-1/4	5.5
		3/8	1/4	1.375	1.004	1-1/4	5.8
		1/2	1/2	2.219	1.656	1-1/2	10
		1/2	1/4	1.875	1.375	1-1/2	5.8
		1/2	3/8	1.875	1.375	1-1/2	5.4
		3/4	3/4	2.406	1.906	1-7/8	17

Based on the largest/heaviest version of each type.



OVERVIEW: CHECK VALVES

- Positive drip-free shut-off maintains line pressure during on/off spraying cycles
- Minimal pressure drop through CV and diaphragm valves

CHECK VALVE OPTIONS**AB Ball**

1/8", 1/4" male inlet and female outlet conn.
 Max. pressure: 125 psi (9 bar)
 Max. flow rate: 2 gpm (8 lpm)
 5, 10 or 20 psi (0.35, 0.7 or 1.5 bar) opening pressures
 Materials: Aluminum, brass, stainless steel

**BB Ball**

1/4" male inlet and male outlet conn.
 Max. pressure: up to 125 psi (9 bar)
 Max. flow rate: 0.5 gpm (2 lpm)
 5, 10, 20 or 25 psi (0.35, 0.7, 1.5 or 1.7 bar) opening pressures
 Materials: Brass, stainless steel

**10742A Diaphragm**

1/8", 1/4" male inlet and female outlet conn.
 Max. flow rate: 2 gpm (8 lpm)
 7 psi (0.5 bar) opening pressure
 Materials: Aluminum, brass

**12328 Diaphragm**

1/2", 3/4" male inlet and female outlet conn.
 Max. flow rate: 15 gpm (57 lpm)
 7 psi (0.5 bar) opening pressure
 Material: Nylon

**CV Series**

AACV 1/8", 1/4" female inlet and female outlet conn.
 BACV 1/8", 1/4" male inlet and female outlet conn.
 ABCV 1/8", 1/4" female inlet and male outlet conn.
 BBCV 1/8", 1/4" male inlet and male outlet conn.
 Max. pressure: 150 psi (10 bar)
 5, 10 or 20 psi (0.35, 0.7 or 1.5 bar) opening pressures
 Materials: Brass, stainless steel

**MATERIAL****CODE**

Aluminum	AL
Brass	No code
Nylon	NYB
303 stainless steel	SS

ORDERING INFORMATION**AB AND BB BALL-TYPE CHECK VALVES**

BSPT connections require the addition of a "B" prior to the inlet connection.
Opening pressure is ordered in psi.

10742A DIAPHRAGM CHECK VALVE

BSPT connections require the addition of a "B" prior to the inlet connection.

12328 DIAPHRAGM CHECK VALVE

BSPT connections require the addition of a "B" prior to the inlet connection.

CV SERIES CHECK VALVE

BSPT connections require the addition of a "B" prior to the inlet connection.
Opening pressure is ordered in psi.

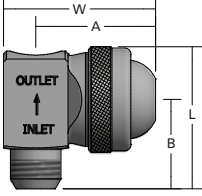
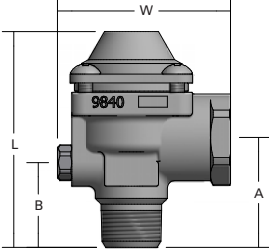
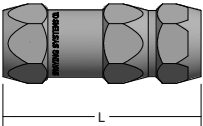
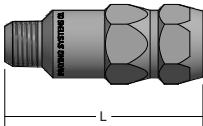
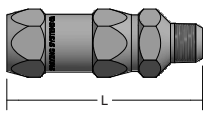
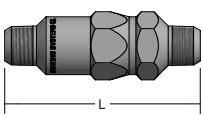

DIMENSIONS AND WEIGHTS

Check Valve	Accessory Type	Inlet Conn. (in.)	Outlet Conn. (in.)	A (in.)	B (in.)	L (in.)	D (Dia.) (in.)	W (in.)	Hex. (in.)	Net Weight (oz.)
	AB	1/8 (M)	1/8 (F)	–	–	1.813	–	–	5/8	2
		1/4 (M)	1/4 (F)	–	–	2.313	–	–	13/16	3.33
	BB	1/4 (M)	1/4 (M)	–	–	0.954	0.609 dia.	–	9/16	1.10
	10742A	1/8 (M)	1/8 (F)	1.412	0.906	1.422	–	1.07	0.688 sq.	3.73
		1/4 (M)	1/4 (F)	1.412	0.953	1.469	–	1.07	0.688 sq	3.73
	12328	1/2 (M)	1/2 (F)	1.624	1.219	3.343	–	3.063	–	25.75
		3/4 (M)	3/4 (F)	1.624	1.219	3.343	–	3.063	–	25.75
	AACV	1/8 (F)	1/8 (F)	–	–	2.340	–	–	13/16	3.25
		1/4 (F)	1/4 (F)	–	–	2.340	–	–	13/16	3.54
	BACV	1/8 (M)	1/8 (F)	–	–	2.280	–	–	13/16	3.25
		1/4 (M)	1/4 (F)	–	–	2.340	–	–	13/16	3.54
	ABCV	1/8 (F)	1/8 (M)	–	–	2.680	–	–	13.16	3.25
		1/4 (F)	1/4 (M)	–	–	2.340	–	–	13/16	3.69
	BBCV	1/8 (M)	1/8 (M)	–	–	2.620	–	–	13/16	3.72
		1/4 (M)	1/4 (M)	–	–	2.340	–	–	13/16	3.70

Based on the largest/heaviest version of each type.



OVERVIEW: PLUG AND BALL VALVES

- Easy in-line shut-off
- Manual operation
- Ball valve provides more robust operation than plug valves
- Max. pressure: 400 psi (27 bar)

PLUG VALVE OPTIONS

23220 Plug Valve, Female x Female

Available in:

- 1/8" female inlet and 1/8" female outlet conn.
- 1/4" female inlet and 1/8" female outlet conn.
- 1/4" female inlet and 1/4" female outlet conn.

Materials: Brass body with Celcon® plug handle



23220 Plug Valve, Female x T Outlet

Available in:

- 1/4" female inlet and T outlet conn.
- 1/4" female inlet conn. and 11/16"-16 UniJet® thread outlet

Materials: Brass body with Celcon plug handle



23220 Plug Valve, Male x T Outlet

Available in:

- 1/4" male inlet and T outlet conn.
- 1/4" male inlet conn. and 11/16"-16 UniJet thread outlet

Materials: Brass body with Celcon plug handle



23220 Plug Valve, Male x Female

Available in:

- 1/4" male inlet and 1/4" female outlet conn.

Materials: Brass body with Celcon plug handle



23220 Plug Valve, Female x Male

Available in:

- 1/4" female inlet and 1/4" male outlet conn.

Materials: Brass body with Celcon plug handle



BALL VALVE OPTIONS

20900 Ball Valve

On/off ball type

UniJet system compatible

1/4" male or female inlet and 11/16"-16 UniJet thread outlet

Materials: Brass body and handle; stainless steel ball



ORDERING INFORMATION

PLUG VALVES



BSPT connections require the addition of a "B" prior to the inlet connection.

DIMENSIONS AND WEIGHTS

Valve	Accessory Type	Inlet Conn. (in.)	Outlet Conn. (in.)	L (in.)	H (in.)	Net Weight (oz.)
	23220	1/4 (F)	1/8 (F)	1-3/4	1-5/32	2.08
		1/4 (F)	1/4 (F)	1-3/4	1-5/32	2.08
		1/8 (F)	1/8 (F)	1-3/4	1-5/32	2.43
	23220	1/4 (M)	11/16-16	2-1/8	1-5/32	2.25
	23220	1/4 (F)	11/16-16	2-1/8	1-5/32	2.29
	23220	1/4 (M)	1/4 (F)	1-3/4	1-5/32	2.08
	23220	1/4 (F)	1/4 (M)	1-3/4	1-5/32	1.98
	20900	1/4 (M)	11/16-16	2-5/16	1-5/16	3.06
		1/4 (F)	11/16-16	2-5/16	1-5/16	3.24

Based on the largest/heaviest version of each type.



OVERVIEW: THROTTLING AND PRESSURE RELIEF/REGULATING VALVES

- Easily regulate flow in systems using centrifugal pumps with throttling valves; adjustable cap and lock ring provide easy valve control
- Control line pressure and minimize liquid waste with adjustable relief valves that return excess liquid back to the liquid source or pump inlet

PRESSURE RELIEF REGULATING VALVE OPTIONS

23120

1/2", 3/4" male inlet and female outlet conn.
 Pressure relief valve
 Adjustable lock nut
 Material: Polypropylene



8460

1/2", 3/4" male inlet and female bypass conn.
 Diaphragm-style pressure relief valve
 Female pressure gauge port and plug for use when pressure gauge not used
 Fairprene® diaphragm seal prevents fluid from working parts
 Materials: Aluminum housing with nylon body



6815

1/2", 3/4" male inlet and female outlet conn.
 Piston-type pressure relief valve
 Free floating design improves speed and sensitivity
 Materials: Aluminum, brass, hardened stainless steel



110

1", 1-1/4", 1-1/2" conn.
 Piston-type pressure relief valve
 Guide vane seat stabilizes flow for vibration reduction
 Free floating design improves speed and sensitivity
 Removable valve bonnet: no disturbance of fluid line connections
 Materials: Aluminum, brass, ductile iron, hardened stainless steel



THROTTLING VALVE OPTION

23520

1/2", 3/4" male inlet and female outlet conn.
 Throttling valve
 Material: Polypropylene



MATERIAL

CODE

Aluminum	AL
Brass	No code
Ductile Iron	No code
Hardened stainless steel	HSS
Nylon/Aluminum	NY
Polypropylene	PP

See Trademark Registration and Ownership, page i-1.



ORDERING INFORMATION

PRESSURE RELIEF/REGULATING VALVE



BSPT connections require the addition of a "B" prior to the inlet connection. Pressure rating is ordered in psi.

THROTTLING VALVE



BSPT connections require the addition of a "B" prior to the inlet connection.

SPECIFICATIONS

Inlet/Outlet Pipe Conn. (in.)	Operating Pressure Max. psi (bar)	Valve Type							
		23520	23120	8460	6815	6815-HSS	6815-AL	110	110-AL
1/4	Up to 300 (20)							•	
	300 to 700 (20 to 48)							•	
	700 to 1000 (48 to 70)							•	
3/8	Up to 300 (20)							•	
	300 to 700 (20 to 48)							•	
	700 to 1000 (48 to 70)							•	
1/2	Up to 50 (3.5)				•		•		
	Up to 150 (10.4)	•	•						
	Up to 300 (20)			•	•		•		
	300 to 700 (20 to 48)				•		•		
	700 to 1200 (48 to 85)				•	•			
3/4	Up to 50 (3.5)				•		•		
	Up to 150 (10.4)	•	•						
	Up to 300 (20)			•	•		•		
	300 to 700 (20 to 48)				•		•		
	700 to 1200 (48 to 85)				•	•			
1	Up to 150 (10)								•
1-1/4	Up to 150 (10)								•
1-1/2	Up to 150 (10)								•

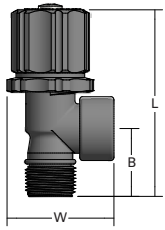
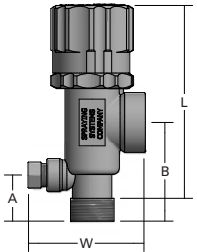
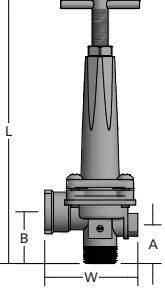
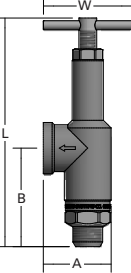
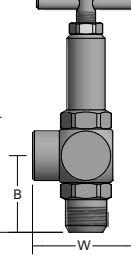

DIMENSIONS AND WEIGHTS

Valve	Accessory Type	Inlet/Outlet Conn. (in.)	L at Max. Opening Height (in.)	A (in.)	B (in.)	W (in.)	Net Weight (oz.)
	23520	1/2	4	–	1.175	2	2.9
		3/4	4.5	–	1.409	2.25	2.9
	23120	1/2	5.25	1.063	2.375	2.63	5.65
		3/4	5.25	1.063	2.375	2.69	5.75
	8460	1/2	8	1.218	1.624	2.813	14.8
		3/4	8	1.218	1.624	2.813	14.5
	6815	1/2	6.625	1.191	2.750	2.5	20
		3/4	6.625	1.191	2.750	2.5	20
	110	1/4	4	–	1.219	1.69	7.1
		3/8	4	–	1.219	1.69	7.1
		1	7.25	–	2.515	2.69	43.4
		1-1/4	7.5	–	2.610	2.75	49.8
		1-1/2	7.75	–	4.210	2.968	56

Based on the largest/heaviest version of each type.



SOLENOID VALVES

- On/off flow control in automatically operated systems
- Dependable performance in air and liquid lines with temperatures from 40° to 165°F (5° to 75°C)
- Ten watt, class “F” coils are for continuous duty; UL and CSA approved; suitable for international use
- Encapsulated coil resists high humidity and fungus growth
- 360° rotation available with durable electrostatically powder-coated enclosure
- Stainless steel pilot orifice helps eliminate premature leaking and increases service life in high flow velocity situations
- Floating plungers automatically compensate for vibration, shock, wear and deformation while providing a bubble-tight seal
- Versatile mounting in any position; direct pipe mounting

SOLENOID VALVE OPTIONS

2-Way

1/4", 3/8", 1/2", 3/4", 1" conn.

Direct-acting poppet or pilot-operated diaphragm valve action

Materials: Brass, stainless steel



3-Way

1/4", 3/8", 1/2" conn.

Poppet or diaphragm valve action

Materials: Brass, stainless steel



ORDERING INFORMATION

COMPLETE SOLENOID VALVE*

<div style="border: 1px solid black; padding: 10px; width: fit-content; margin: 0 auto;"> Model No. </div>	Example <div style="border: 1px dashed black; padding: 5px; width: fit-content; margin: 0 auto;"> 11438-20 </div>
--	--

BSPT connections require the addition of a “B” prior to the inlet connection.

*110 or 120 V, 50/60 Hz coil is standard. If other coil assemblies are desired, add the appropriate letter code to the end of the part number. For example: 11438-20A.

A = 220 or 240 V, 50/60 Hz

B = 24 V, 60 Hz

C = 12 VDC

D = 24 VDC



SPECIFICATIONS

Port Conn. (in.)	Valve Action	Valve Type	Model Number	Max. Pressure (psi)	Orifice Size (in.)	Cv Factor**	Body Material	Seal Material
1/4	Direct Acting Poppet	2-way	11438-20	60*	3/16	.50	Stainless steel	Viton®
1/4	Direct Acting Poppet	2-way	11438-21	205*	1/8	.28	Stainless steel	Kel-F®
3/8	Pilot-Operated Diaph.	2-way	11438-22	150*	7/16	2.5	Forged or cast brass	Buna-N
1/2	Pilot-Operated Diaph.	2-way	11438-23	150*	5/8	4.0	Forged or cast brass	Buna-N
3/4	Pilot-Operated Diaph.	2-way	11438-24	230	3/4	7.8	Forged or cast brass	Buna-N
1	Pilot-Operated Diaph.	2-way	11438-25	230	1	13.0	Forged or cast brass	Buna-N
1/4	Poppet	3-way	11438-30	100	3/32	.25/38	Forged or cast brass	Viton
1/2	Diaph.	3-way	11438-31	150	1/2	3.6	Forged or cast brass	Buna-N
3/8	Diaph.	3-way	11438-32	150	7/16	1.6/2.5	Aluminum	Buna-N

*For maximum pressures of coils "C" and "D", request Data Sheet 11438 – Solenoid (1).

**For use of Cv Factor, request Data Sheet 11438 – Solenoid (2).

See Trademark Registration and Ownership, page i-1.

DIMENSIONS AND WEIGHTS

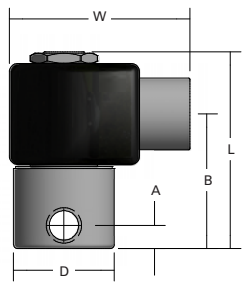
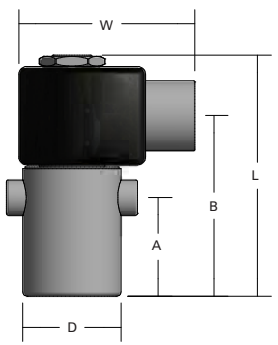
Solenoid Valve	Accessory Type	A (in.)	B (in.)	D (Dia.) (in.)	L (in.)	W (in.)	Net Weight (oz.)
	11438-20	0.344	1.938	1.625	2.906	2.76	20.3
	11438-21	0.344	1.938	1.625	2.906	2.76	20.3
	11438-22	0.594	2.594	1.969	3.563	2.76	19.9
	11438-23	0.531	3.406	2.656	4.406	2.76	35.9
	11438-24	0.875	3.719	3.938	4.750	2.76	61
	11438-25	0.875	3.719	3.938	4.750	2.76	34.4
	11438-30	1.125	2.750	1.563	3.750	2.76	21.3
	11438-31	1.063	3.156	3.094	5.625	2.76	25.3
	11438-32	1.500	3.750	1.375	4.375	2.76	12.4

Based on the largest/heaviest version of each type.

LIQUID AND AIR PRESSURE REGULATORS

- Diaphragm-type non-relieving liquid pressure regulators
 - Operating temperature range: 35° to 200°F (2° to 93°C)
 - Gauges supplied separately
- Diaphragm-type, relieving and non-relieving style air pressure regulators
 - Relieving style automatically relieves excessive air pressure in a regulated line; non-relieving types also available
 - Regulated line pressure can be reduced with adjusting knob even when line is dead ended
 - Operating temperature range: 0° to 175°F (-15° to +80°C) with dew point less than air temperatures below 35°F (2°C)
 - Gauges supplied separately

REGULATOR OPTIONS

11438 Air Pressure Regulator

Diaphragm, relieving and non-relieving types
 Regulated pressures from 5 to 125 psi (0.3 to 8.5 bar) with supply line pressures up to 300 psi (20 bar)
 Materials: Die cast aluminum, stainless steel, zinc



11438 Liquid Pressure Regulator

Non-relieving type
 Regulated pressures from 5 to 125 psi (0.3 to 8.5 bar) with primary supply line pressures
 Max. pressure: 400 psi (28 bar)
 Materials: Brass, brass-plated zinc or stainless steel



ORDERING INFORMATION

AIR PRESSURE REGULATOR

Regulator No.	Example 11438-45
---------------	----------------------------

LIQUID PRESSURE REGULATOR

Regulator No.	Example 11438-250
---------------	-----------------------------

SPECIFICATIONS

Regulator Type	Regulator Style	Regulator Number	Max. Pressure (psi)	Main Ports (in.)	Gauge Ports (in.)	Material
Air	Non-relieving	11438-35	300	1/4	1/4	Zinc
		11438-36	300	3/8	1/4	Zinc
		11438-37	300	1/2	1/4	Zinc
		11438-38	300	3/4	1/4	Aluminum
		11438-39	300	1	1/4	Aluminum
	Relieving	11438-45	300	1/4	1/4	Zinc
		11438-45S	300	1/4	1/8	316 stainless steel
		11438-46	300	3/8	1/4	Zinc
		11438-47	300	1/2	1/4	Zinc
		11438-47S	300	1/2	1/4	316 stainless steel
11438-48		300	3/4	1/4	Aluminum	
Liquid	Diaphragm	11438-250	400	1/4	1/4	Brass
		11438-251	400	3/8	1/4	Brass
		11438-252	400	1/2	1/4	Brass
		11438-253	400	3/4	1/8	Brass
		11438-254	400	1	1/8	Brass

Stainless steel versions meet NACE standard MR-01-75 for corrosion resistance

DIMENSIONS AND WEIGHTS

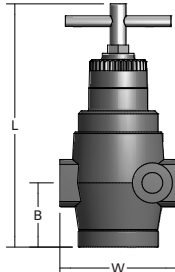
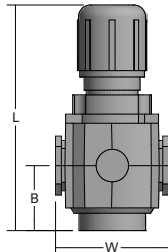
Regulator	Accessory Type 11438-	B (in.)	L (in.)	W (in.)	Net Weight (oz.)
	250, 251	1.500	5.750	2.750	42.7
	252	1.594	5.938	3.313	47.6
	253, 254	1.625	9.500	5.000	129.1
	35, 36, 45, 46	1.438	5.125	2.750	21.6
	37, 47	1.500	5.875	3.500	30.5
	38, 39, 48, 49	2.375	6.875	4.250	54.3
	45S	0.375	2.750	1.500	5.5
	47S	1.625	7.813	3.500	7.2

Based on the largest/heaviest version of each type.



LIQUID PRESSURE GAUGES

- Easy-to-read gauges with bottom inlet connection or center back connection
- Patented spring-suspended movement protected by a corrosion- and impact-resistant ABS housing with polycarbonate window
- Dual scales: psi and bar
- Grade B accuracy within $\pm 2\%$ in the middle 50% of the scale, with 3% accuracy in the high and low ends of the scale
- 0 psi to a maximum of 300 psi (0 bar to a maximum of 20 bar)
- Materials: All wetted parts are brass; combination brass/bronze connection; bourdon tube

GAUGE OPTIONS

26383

1/8", 1/4" center back male conn.
2" (51 mm) dia. housing



26385

1/4" bottom male conn.
2-1/2" (64 mm) dia. housing



ORDERING INFORMATION

PRESSURE GAUGE 26383

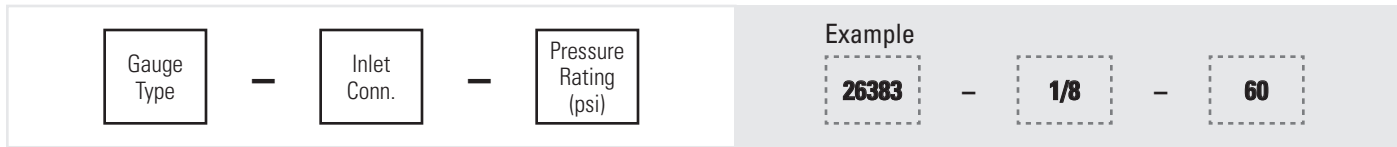

Pressure rating is ordered in psi.

PRESSURE GAUGE 26385

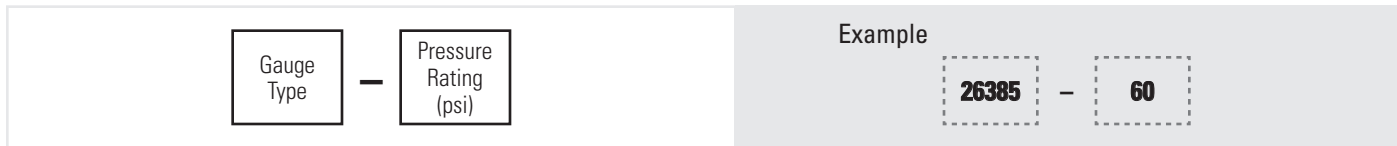

Pressure rating is ordered in psi.

SPECIFICATIONS

Gauge Type	Inlet Conn. (M)	Pressure Rating psi (bar)	Pressure Range psi (bar)
26383	1/8, 1/4	60 (4)	0 – 60 (0 – 4)
	1/8, 1/4	100 (7)	0 – 100 (0 – 7)
	1/8, 1/4	160 (11)	0 – 160 (0 – 11)

Gauge Type	Inlet Conn. (M)	Pressure Rating psi (bar)	Optimum Operating Range psi (bar)
26385	1/4	60 (4)	15 – 45 (1.0 – 3.1)
	1/4	100 (7)	25 – 75 (1.7 – 5.2)
	1/4	160 (11)	40 – 120 (2.8 – 8.3)
	1/4	300 (21)	75 – 225 (5.2 – 15.5)

OVERVIEW: HOSES AND MOUNTING BASES

- Bendable hoses stay in place once they are positioned
 - Works with a variety of nozzle types
 - Lengths: 6", 12", 18", 24", 30" and 36" (15, 30, 46, 61, 76 and 91 cm)
 - Max. pressure: 250 psi (17.5 bar)
 - Max. operating temperature: air – 250°F (121°C); liquid – 200°F (93°C)
 - Max. operating flow at 250 psi (17.5 bar): 33 scfm (934 Nlpm)
- Magnetic mounting bases provide fast, easy set-up of nozzles
 - Shut-off valve assembled on base

**STAY-N-PLACE HOSE OPTIONS****57020**

1/4" male x 1/4" female conn.

**57025**

1/4" male x 1/4" male conn.

**MAGNETIC MOUNTING BASE OPTIONS****57045**

Single or double outlet



ORDERING INFORMATION

STAY-N-PLACE HOSES

<div style="border: 1px solid black; padding: 5px; display: inline-block;">Model No.</div> - <div style="border: 1px solid black; padding: 5px; display: inline-block;">Hose Length</div>	<p>Example</p> <div style="border: 1px dashed gray; padding: 5px; display: inline-block; margin-right: 10px;">57020</div> - <div style="border: 1px dashed gray; padding: 5px; display: inline-block;">6</div>
---	--

BSPT connections require the addition of a "B" prior to the model number. Example: B57020
Hoses are ordered in inch lengths.

MAGNETIC MOUNTING BASE

<div style="border: 1px solid black; padding: 5px; display: inline-block;">Base No.</div> - <div style="border: 1px solid black; padding: 5px; display: inline-block;">Outlet Number</div>	<p>Example</p> <div style="border: 1px dashed gray; padding: 5px; display: inline-block; margin-right: 10px;">57045</div> - <div style="border: 1px dashed gray; padding: 5px; display: inline-block;">001</div>
--	--

Use 001 for single outlet; 002 for double outlet
BSPT connections require the addition of a "B". Example: B57045

DIMENSIONS AND WEIGHTS

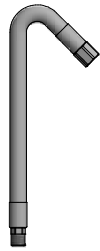
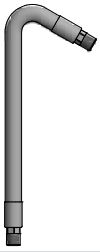
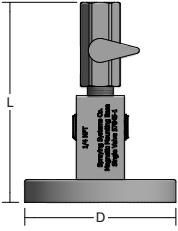
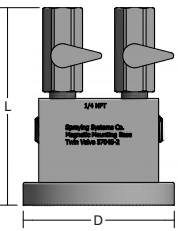
Hose, Base	Accessory Type	Hose Length (in.)	Inlet Conn. (in.)	L (in.)	D (Dia.) (in.)	Net Weight (oz.)
	57020	6	1/4	-	0.69	0.3
		12	1/4	-	0.69	0.5
		18	1/4	-	0.69	0.7
		24	1/4	-	0.69	0.9
		30	1/4	-	0.69	1.0
		36	1/4	-	0.69	1.2
	57025	6	1/4	-	0.69	0.3
		12	1/4	-	0.69	0.5
		18	1/4	-	0.69	0.7
		24	1/4	-	0.69	0.9
		30	1/4	-	0.69	1.0
		36	1/4	-	0.69	1.2
	57045-1	-	1/4	2.220	3.15	27.20
	57045-2	-	1/4	2.220	3.15	27.20

Based on the largest/heaviest version of each type.